

# Mounting Instruction

## Product Parameters

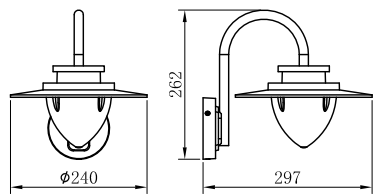

1. Model: 5083
2. Rated Voltage: AC 100-240V
3. Rated Power: LED 8W
4. IP Grade: IP54
5. Insulation protection level: Class I
6. Operating Temperature:  $-30\sim+45^{\circ}\text{C}$

## Components and Tools

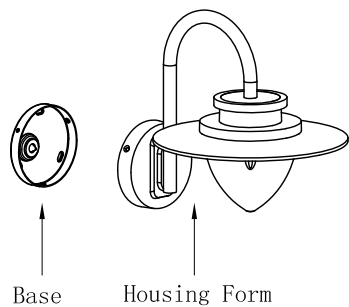

Base

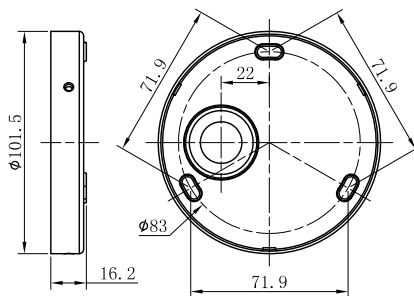

Mounting holes

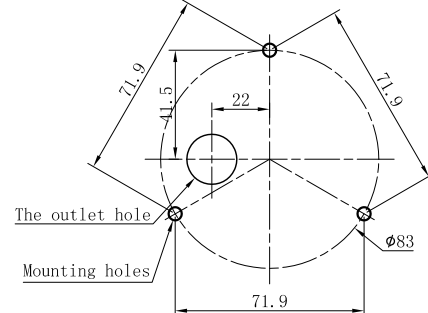

## Installation Steps

A



OFF

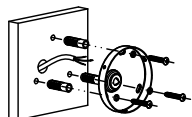

▲ Please be sure to fasten tightly of the base.

B

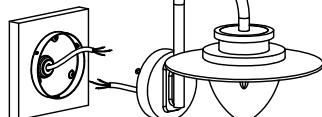

▲ Wiring must be operated in accordance with construction specifications.

C

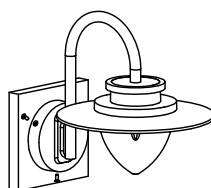

▲ Make sure the screws be fixed tightly.

D



ON



▲ Connect the power supply, and light up the lamp.

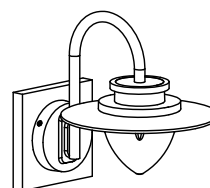

E

F

G

H

## Attention

1. Lamp should be installed by professional electrician;
2. The light source contained in this luminaire shall only be replaced by the manufacturer or his service agent or a similar qualified person;
3. Check the power switch has been turned off;

4. Please read this user guide carefully before installation and keep for future reference;
5. If the external flexible cable or cord of this luminaire is damaged, it shall be exclusively replaced by the manufacturer or his service agent or a similar qualified person in order to avoid a hazard.