

ATENCIÓN: Schuller recomienda que utilice los balancines suministrados en la instalación de esta lámpara.

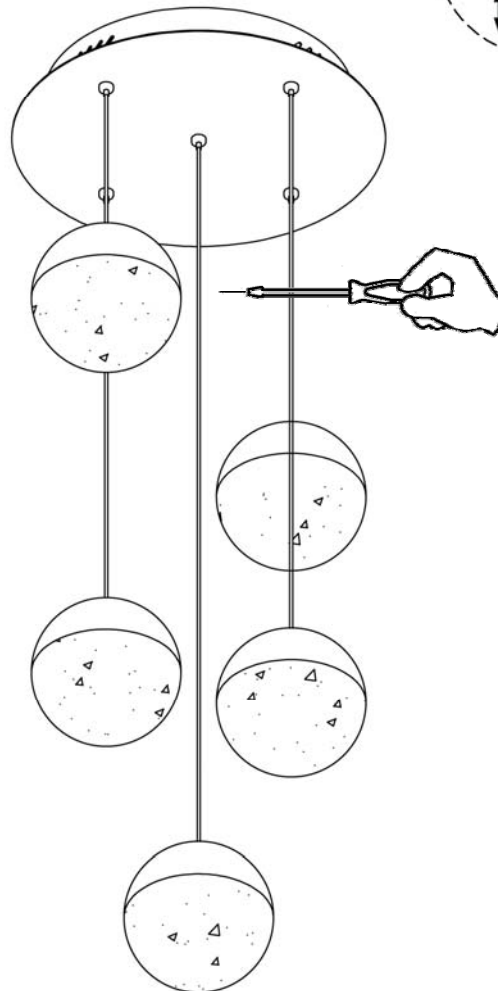
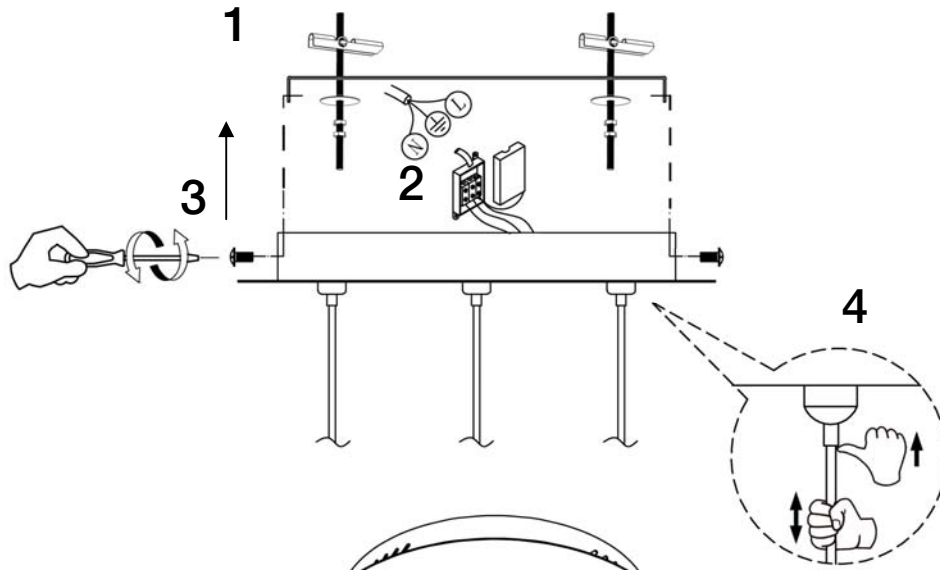

NOTA IMPORTANTE:
Para corregir la torsión natural del cordón rizado, frotar el cable con un destornillador o una varilla rígida, como indica la figura.

NOTA IMPORTANTE

Este producto incluye drivers led con dimado de 0-10V o PWM. Para utilizar con regulador de pared, usar sólo dimmers de estos dos tipos de regulación.

Para ver la ficha técnica de producto completa, puede usar el siguiente código QR:



ASSEMBLING INSTRUCTIONS

ITEM 793534

DIMMABLE ITEM

ATTENTION: Schuller recommends to use included special screws when installing this lamp.

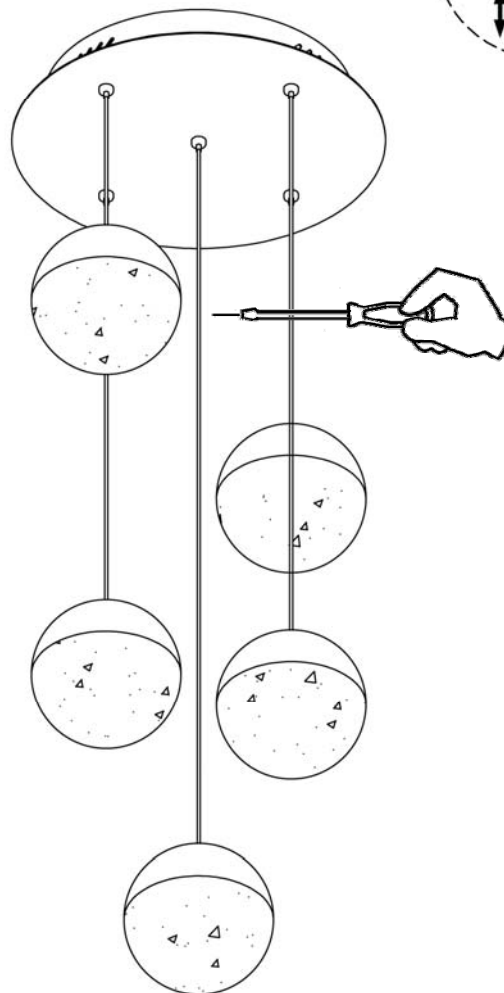
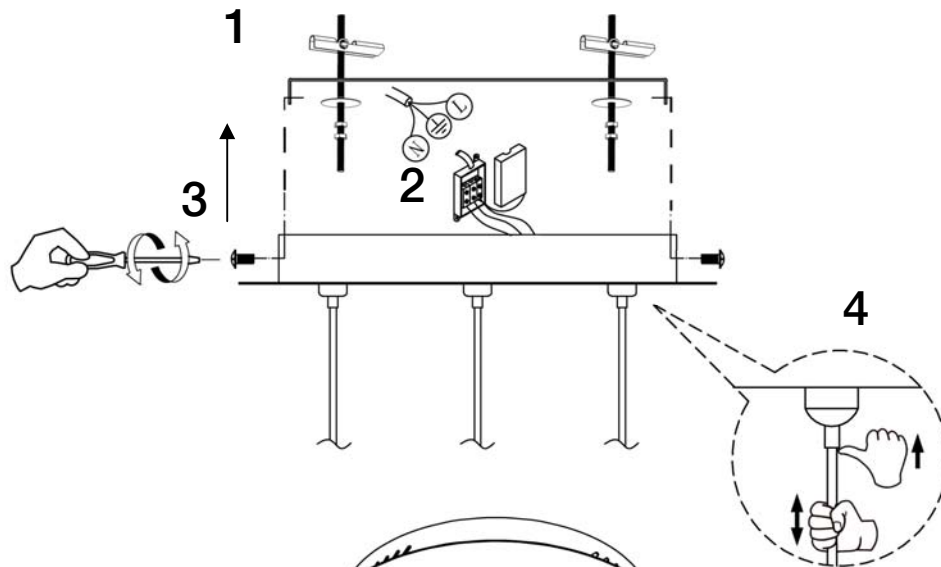

NB:
If the cable is twisted,
please hold the bottom of
the cable, and use a
screwdriver or a metal rod
to stroke the cable up and
down to keep it straight.

IMPORTANT NOTICE

This product includes LED drivers with 0-10V or PWM dimming. To use it with wall dimmer, use just this type of dimmers.

You may use the following QR code to view the complete technical data sheet of the product:



If you have any technical questions, please do not hesitate to contact our technical Department.
We are at your disposal in our email: irodriguez@schuller.es