

ATENCIÓN: Schuller recomienda que utilice los balancines suministrados en la instalación de esta lámpara.

IMPORTANTE

Comenzar la instalación siempre por el florón grande.

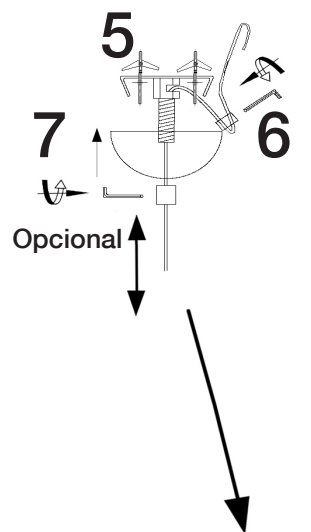
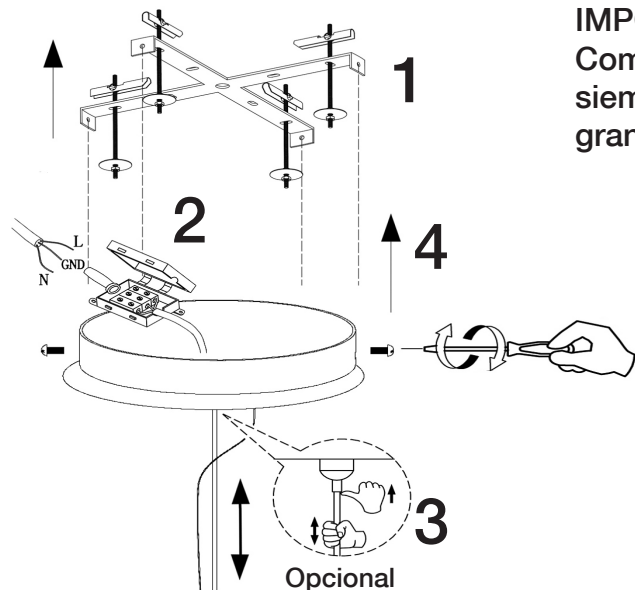

Artículo pesado 25kg.
 El montaje y la manipulación de este artículo debe hacerse entre dos personas.

No utilizar, productos de limpieza, que contengan disolvente o alcohol. Dañan el metacrilato.

ATENCIÓN

Este producto incluye leds con dimado de 0-10V y TRIAC. Para utilizar con regulador de pared, usar sólo dimmers de estos dos tipos de regulación

Este producto incluye kit de dimado (Ref. 600811): interruptor inalámbrico y receptor dimable.

Para ver la ficha técnica de producto completa, puede usar el siguiente código QR:



ATTENTION: Schuller recommends to use included special screws when installing this lamp.

IMPORTANT NOTICE
Always start the installation of the pendant at the large canopy.

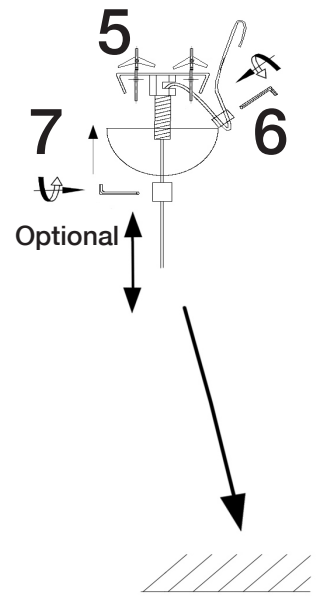
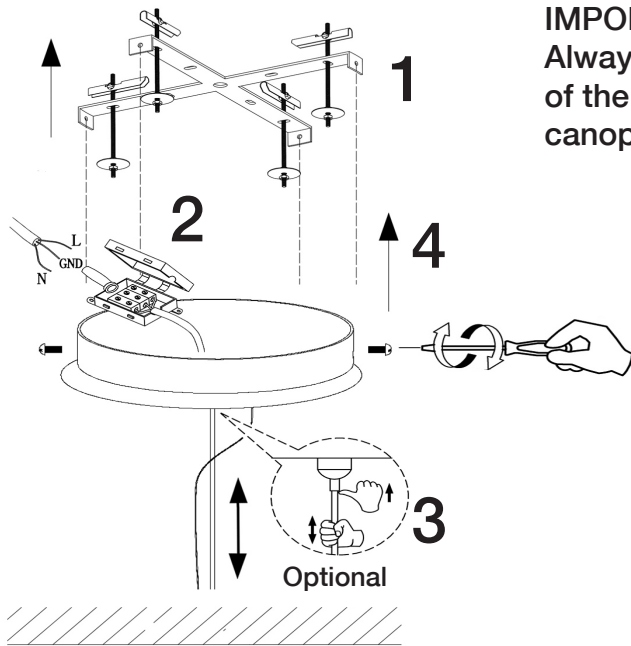

Heavy item 25kg.
The assembly of this lamp must be done by two people

Do not use any cleaning products that contain solvents or alcohol as they will damage the methacrylate.

ATTENTION
This product includes LEDs with 0-10V and TRIAC dimming. To use it with wall dimmer, use just this type of dimmers.

This product includes dimming kit (Ref. 600811): wireless switch and dimmable receiver.

You may use the following QR code to view the complete technical data sheet of the product:



If you have any technical questions, please do not hesitate to contact our technical Department. We are at your disposal in our email: export@schuller.es