

aromas ASSEMBLY INSTRUCTIONS

S1283

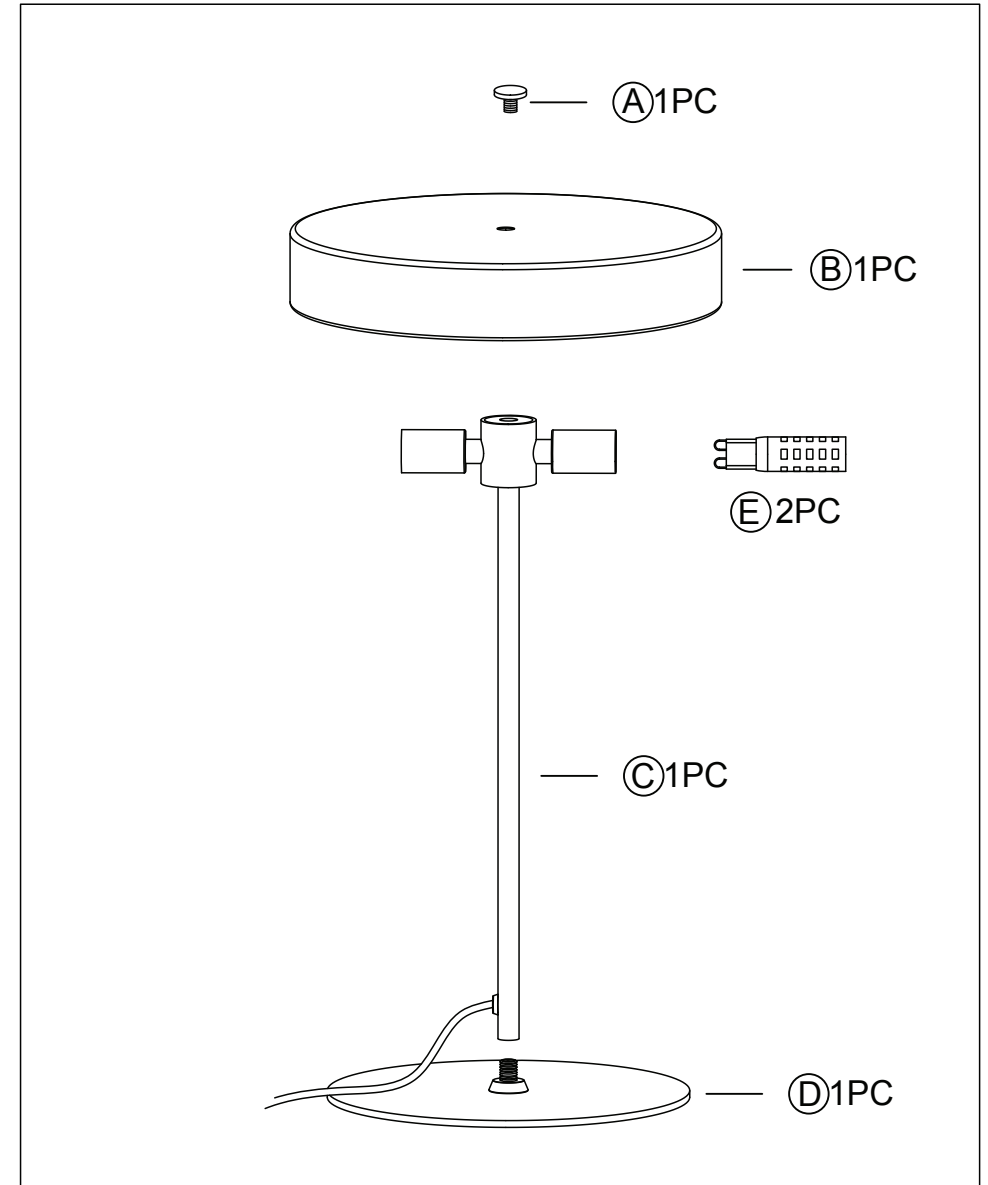
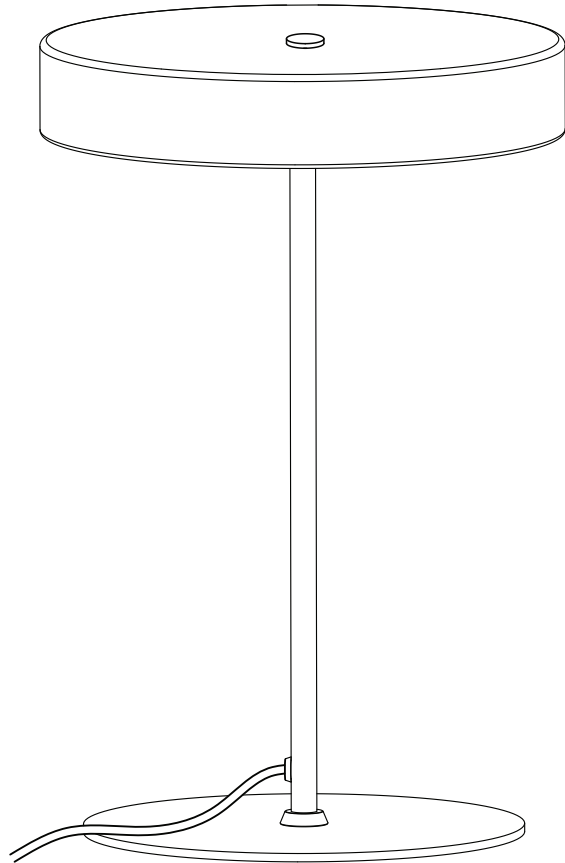

Caution: If the external flexible cable or cord of this luminaire is damaged, it should be replaced by a qualified person in order to avoid a hazard.

1

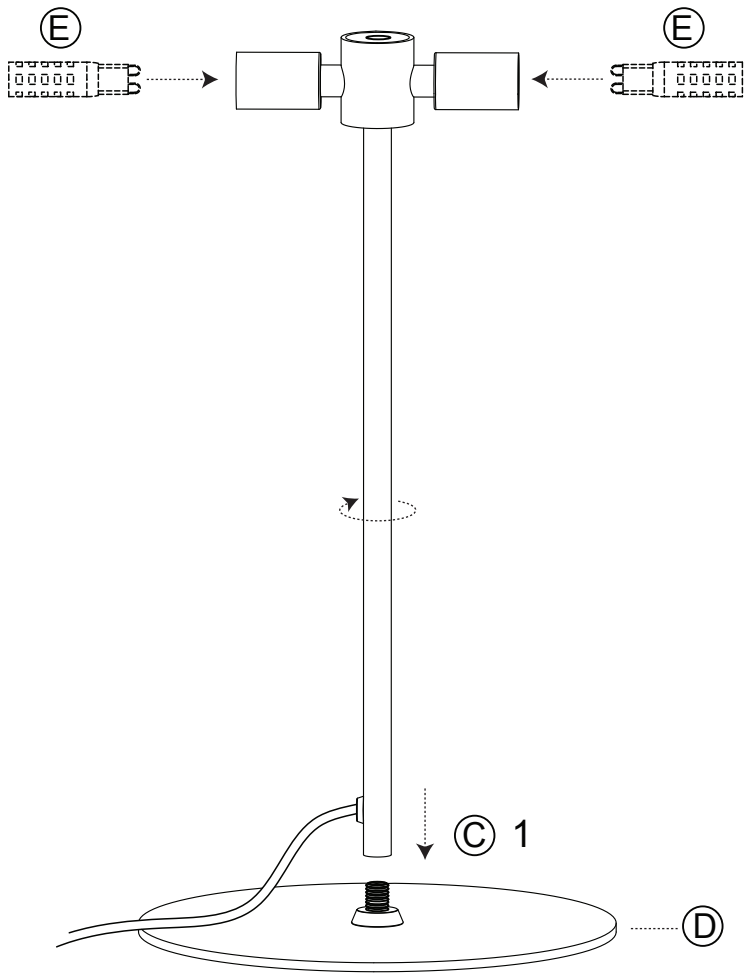

2

