



# ATMOSS<sup>®</sup>

LIGHTING

Nos ubicamos en el Polígono de Santa Pola, ocupando un espacio de 6000m<sup>2</sup> distribuidos en 10 **naves industriales**. Estas modernas instalaciones destacan por su amplitud y luminosidad, creando un entorno propicio para la eficiencia operativa.

Cada una de las 10 naves ha sido diseñada con precisión para optimizar el almacenamiento y la gestión logística. Este extenso espacio nos permite mantener **más de 2000 referencias en stock**, garantizando una oferta diversificada y una respuesta ágil a las necesidades del mercado.

La iluminación en nuestras instalaciones ha sido cuidadosamente planificada para asegurar una visibilidad óptima, contribuyendo a un ambiente de trabajo cómodo y productivo. En Atmoss Electric, nuestras instalaciones no solo reflejan modernidad y eficiencia, sino que también respaldan nuestro compromiso con la excelencia y la disponibilidad inmediata de productos para nuestros clientes.





# NUESTRAS *INSTALACIONES*

## ALMACÉN

6000m<sup>2</sup> repartidos en más de 10 naves, con más de 2000 referencias en stock.

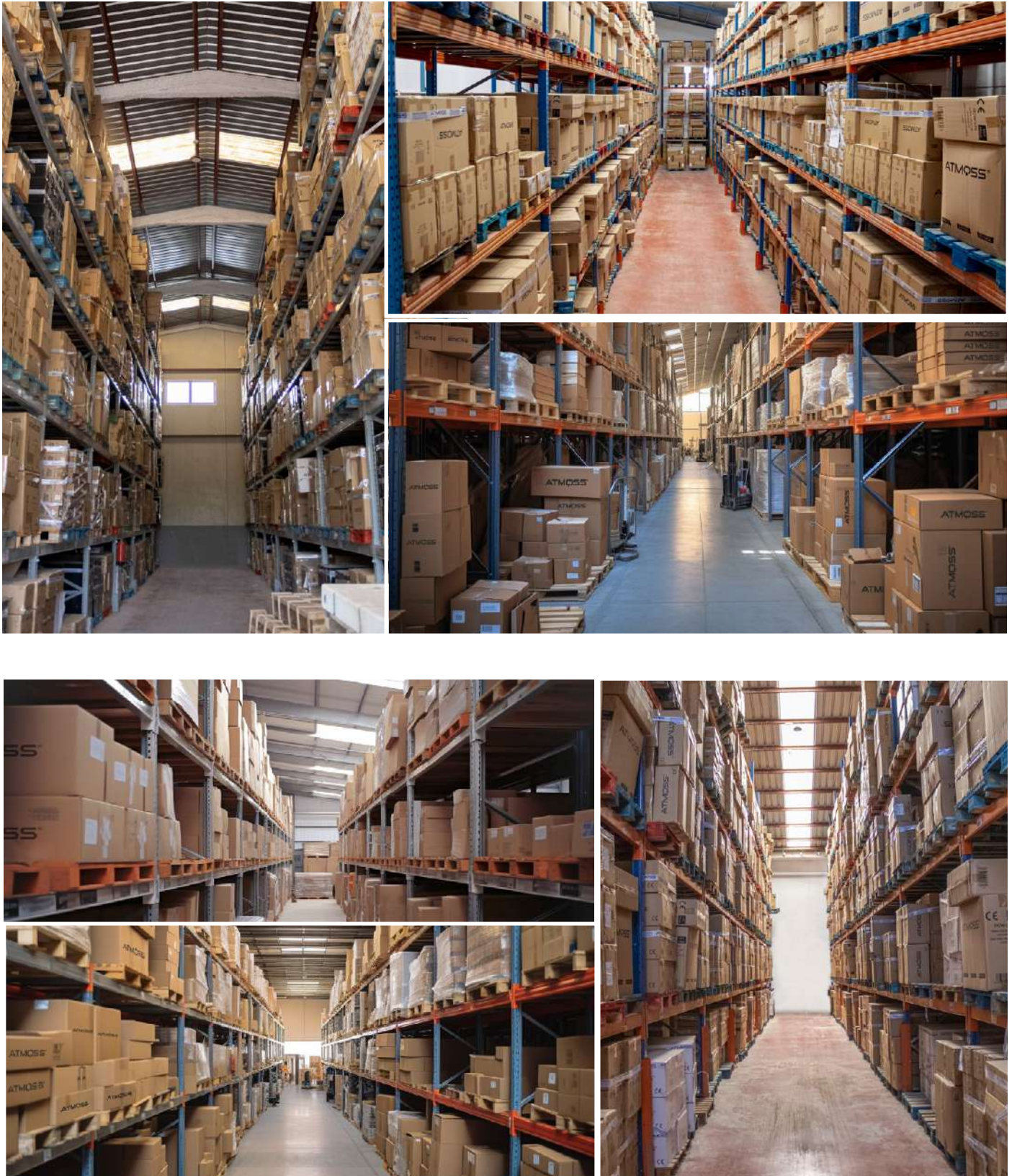



# Iluminación profesional de calidad, responsable con el entorno

**ATMOSS** es una empresa de iluminación profesional creada en 2007 para ofrecer a los técnicos los mejores productos del sector de la iluminación.

Ofrecemos un servicio de calidad que se manifiesta tanto en nuestros productos como en nuestro equipo humano, siempre innovando. De este modo los profesionales pueden tener la confianza de sentirse seguros recurriendo a Atmoss para dar soluciones a sus clientes. Este compromiso de calidad y servicio va unido a una gran responsabilidad por el medioambiente.

## Departamento técnico

Nuestro departamento técnico te asesorará y resolverá tus dudas sobre cualquiera de nuestros productos, con la garantía y rapidez de un gran equipo profesional.



Visita nuestra página web  
[www.atmoss.es](http://www.atmoss.es)

Puedes descargar las fichas técnicas  
desde catálogo online.



Haga click en la flecha azul para  
**DESCARGAR LA FICHA TÉCNICA**





# SIMBOLOGÍA

## • Metros tira de LED

**50 M** Metros de la bobina

## • Almacenamiento

**1** Unidad de producto por caja

Fuente de alimentación de **ALTA CALIDAD**

**LIFUD**  
Led Driver

Batería de **ALTA DURACIÓN** y **BUENA CALIDAD.**  
- Mayor vida útil

Todas nuestras baterías son de Fosfato de Hierro Litio (LiFePO4), son un tipo de baterías recargable de Ión Litio.

La esperanza de vida del LiFePO4 es hasta **10 veces superior** al tiempo de vida de las baterías de plomo ácido y algunos tipos de baterías de ión litio.



## • Grado de protección IP

**IP 20** IP20:  
Evita la entrada de grandes objetos.

**IP 42** IP42:  
Protegido contra la entrada de cualquier objeto y goteo de agua.

**IP 65** IP65:  
Resiste la entrada de chorros de agua.

**IP 66** IP66:  
Protegido frente a inmersiones en aguas breves.

**IP 67** IP67:  
Protegido frente a inmersiones en aguas breves.

**IP 68** IP68:  
Capaz de resistir inmersiones completas y continuadas en agua.

## • Características Iluminación

**≥90 CRI** Índice de reproducción cromática:  
Capacidad de una fuente de luz para mostrar los colores de una manera real, con un rango de 0-100 tomando como referencia la luz natural.

**UGR <19** UGR:  
Índice de deslumbramiento unificado.

**>0,5 FP** FP:  
Factor de potencia

**0-10V** Sistema de variación de intensidad (Dimmable triac):  
Adaptados a las especificaciones de cada producto, desde dimming mediante pulsos (PWM), atenuación de intensidad o modos analógicos (0-10V)

**1018 Lm/m** Flujo luminoso:  
Potencia lumínica emitada por 1m. de tira

**>0,9 FP** FP:  
Factor de potencia



**RGB** RGB:  
Reproduce los colores rojo, verde y azul consiguiendo millones de combinaciones.

**160°** Ángulo de apertura:  
Ángulo de apertura del haz de luz

**3CCT:**  
Posibilidad de cambiar el color de luz entre **3200K-4200K-5000K**  
3 colores de luz en la misma luminaria

**RGBw** RGBw:  
Combina todo el espectro del RGB con la posibilidad de añadir tonos pastel gracias al canal blanco cálido.

**360°** Ángulo de apertura:  
Ángulo de apertura de sensor

## • Conexiones

**WiFi** WiFi.  
Permite control por WiFi. Mediante la app TUYA.

**Bluetooth** Conexión Bluetooth  
Permite control por bluetooth.

**RF** Permite control por radiofrecuencia.

**POE** Sistema POE.  
Es una tecnología para transmisión de datos por cable Ethernet LAN

**tuya** Tuya.  
La aplicación oficial para Home Assistant. Controla tu hogar en cualquier parte del mundo desde la App.

## • Características

**PIR** Sensor de movimiento PIR.  
Detecta movimiento dentro de su campo de acción entre 8 y 10 metros

**Temporizador.**  
Posibilidad de regular el tiempo de encendido.

**Control inteligente de luz.**  
Regulación de la luz en relación a la luz ambiente.

**Mando a distancia.**  
Incluye mando a distancia.

## • Características domótica

**360°** Movimiento horizontal.  
Capacidad de 360° en movimiento horizontal.

**120°** Movimiento vertical.  
Capacidad de 120° en movimiento vertical.

**Grabación de video y captura de imágenes.**  
Grabación de video y captura de imágenes.

**Visión nocturna.**  
Disponible de visión nocturna.

## • Tensión

**230 V** Tensión de funcionamiento del producto.

**24 V**

**12 V**

## • Temperatura de color:

Indicador de temperatura de color de la fuente de luz.





# Índice

08	<b>Lámparas</b>	148	<b>Regleta Led</b>	266	<b>Domótica</b>
38	<b>Aros</b>	154	<b>Tira de Led</b>	318	<b>Mecanismos</b>
54	<b>Aplicques</b>	194	<b>Proyector exterior</b>	354	<b>Material eléctrico</b>
94	<b>Downlight</b>	206	<b>Solar</b>	372	<b>Aparamenta</b>
113	<b>Luminaria lineal</b>	236	<b>Farola</b>	400	<b>Cajas de distribución</b>
118	<b>Track light</b>	244	<b>Emergencia</b>		
134	<b>Panel</b>	250	<b>Sensores</b>		
142	<b>Tubos led - Pantallas</b>	262	<b>Linternas</b>		

Índice enlazado a cada página. 

## NEW PRODUCTS



Pág.10



Pág.28



Pág.57



Pág.57



Pág.167



Pág.97



Pág.241



Pág.208



Pág.199

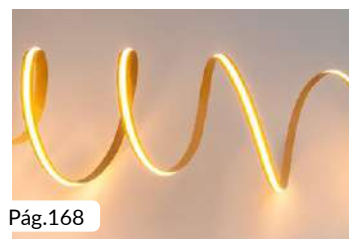

Pág.168



Pág.310



Pág.404



Pág.365



Pág.170

**DESCARGA** NUESTROS  
**CATÁLOGOS** DESDE EL QR



Haz click aqui para  
ver todos nuestros  
catálogos





**Tuya Smart** es la **aplicación más utilizada** en el sector del hogar inteligente.

Su funcionamiento está basado en la gestión de dispositivos inteligentes, proporcionando un control total y remoto, además de configurar escenarios predeterminados que aumentan la usabilidad y calidad de la APP.

## SEGURIDAD

Se trata de la configuración de una red de seguridad compuesta por **alarmas, detectores, cerradura inteligente, cámaras...** Permite controlar cualquier tipo de intrusión mediante cámaras de vigilancia o alarmas personales.

## PERSIANAS

**Controla tu persiana** mediante smartphone, mando, pulsador,...

## ENCHUFES

La mejor forma de **controlar el encendido y apagado de dispositivos** conectados a la electricidad. Puede monitorizar el **ahorro de energía**, proteger contra sobretensiones, desconectar la alimentación de la red eléctrica **mediante tu smartphone**.

## PUERTA GARAJE

**Automatiza tu puerta del garaje**, abre tu puerta sin necesidad de bajar del vehículo.

## ILUMINACIÓN

**Crea diferentes ambientes** con nuestras lámparas WiFi. Controla el encendido o apagado, la regulación o el color desde la App.



## VENTAJAS

- Ayuda para personas con movilidad reducida.
- Ahorro energético.
- Mejor confort.
- Fácil instalación.
- Domotiza tu vivienda a un precio reducido.
- Amplía la cobertura WiFi en tu vivienda.





## Serie *Lámparas & Aros*

---

Iluminación



# Serie Bombillas Vintage

NEW!

SERIE  
VINTAGE



BLED-454

BLED-455

					°K	Ref
Vintage Transparente	A60	E27 4W	500Lm	↓	2700K	BLED-454
Vintage Ámbar	A60	E27 4W	500Lm	↓	2700K	BLED-455

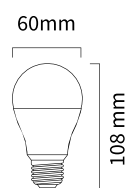

BLED-457

BLED-456

					°K	Ref
Vintage Transparente	S14	E27 4W	500Lm	↓	2700K	BLED-457
Vintage Ámbar	S14	E27 4W	500Lm	↓	2700K	BLED-456

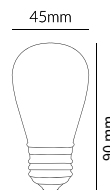

BLED-458

BLED-459

					°K	Ref
Vintage Ámbar Mini esférica	G45	E27 4W	500Lm	↓	2700K	BLED-458
Vintage Ámbar Mini esférica	G45	E14 4W	500Lm	↓	2700K	BLED-459

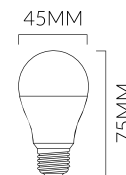

BLED-461

BLED-460

					°K	Ref
Vintage Transparente Edison	ST64	E27 4W	500Lm	↓	2700K	BLED-461
Vintage Ámbar Edison	ST64	E27 4W	500Lm	↓	2700K	BLED-460

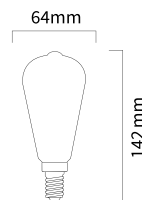

BLED-462

					°K	Ref
Vintage Ámbar Vela	C35	E14 4W	500Lm	↓	2700K	BLED-462

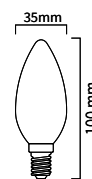



						°K	Ref
Vintage Transparente Vela Ilama	C35	E14 4W	500Lm	2700K	↓	2700K	BLED-464
Vintage Ámbar Vela Ilama	C35	E14 4W	500Lm	2700K	↓	2700K	BLED-463

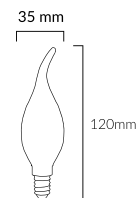

						°K	Ref
Vintage Transparente Globo	G80	E27 4W	500Lm	2700K	↓	2700K	BLED-466
Vintage Ámbar Globo	G80	E27 4W	500Lm	2700K	↓	2700K	BLED-465

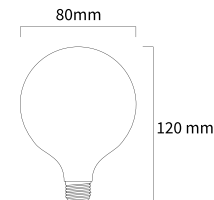

						°K	Ref
Vintage Transparente Globo	G95	E27 4W	500Lm	2700K	↓	2700K	BLED-468
Vintage Ámbar Globo	G95	E27 4W	500Lm	2700K	↓	2700K	BLED-467

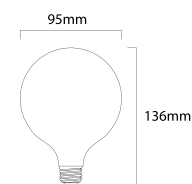

						°K	Ref
Vintage Transparente Globo	G125	E27 4W	500Lm	2700K	↓	2700K	BLED-470
Vintage Ámbar Globo	G125	E27 4W	500Lm	2700K	↓	2700K	BLED-469

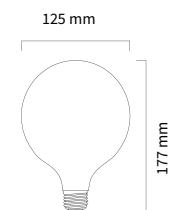

						°K	Ref
Vintage Ámbar Globo Gold	G80	E27 4W	500Lm	2700K	↓	2700K	BLED-471

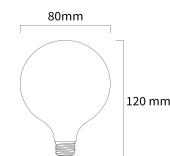

						°K	Ref
Vintage Ámbar Globo Gold	G90	E27 4W	500Lm	2700K	↓	2700K	BLED-472

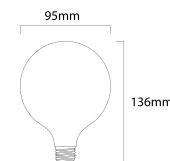

						°K	Ref
Vintage Ámbar Globo Gold	G125	E27 4W	500Lm	2700K	↓	2700K	BLED-473

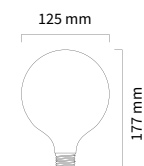

Casquillo E27 acabado oro



Led en Espiral

\* Según la nueva normativa ERP ha habido un cambio en la medición de Lúmenes y vatios, pero sigue emitiendo la misma cantidad de luz. A medida que vayan entrando los nuevos modelos con ERP se irá actualizando en catálogo y cajas de color. Puede haber variación respecto a la caja del producto (comprobar en ficha técnica), todos los datos en catálogo están correctos salvo error tipográfico.



## Serie Lámparas

# ECO



Menos consumo  
Misma eficiencia

### Acabado de color de la lámpara



Dimmable con las pastillas pág.37

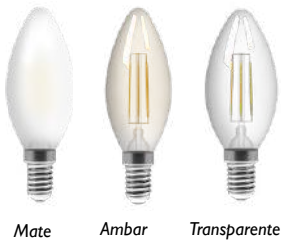

Mate Ambar Transparente

					°K	Ref	PVPR
Vintage Vela Transparente	DIMMABLE TRIAC	C35	E14 5W 700Lm	3200K	3200K	BLED-384	6,60€
Vintage Vela Ambar	DIMMABLE TRIAC	C35	E14 5W 700Lm	3200K	3200K	BLED-385	6,96€
Vintage Vela Mate	DIMMABLE TRIAC	C35	E14 5W 700Lm	3200K	3200K	BLED-386	7,02€



SOLO REGULACIÓN TRIAC

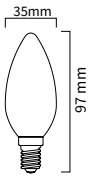

Mate Ambar Transparente

					°K	Ref	PVPR
MiniEsférica Transparente	DIMMABLE TRIAC	G45	E14 6W 900Lm	3200K	3200K	BLED-387	6,60€
MiniEsférica Ambar	DIMMABLE TRIAC	G45	E14 6W 900Lm	3200K	3200K	BLED-388	6,96€
MiniEsférica Mate	DIMMABLE TRIAC	G45	E14 6W 900Lm	3200K	3200K	BLED-389	7,02€



SOLO REGULACIÓN TRIAC

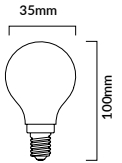

Mate Ambar Transparente

					°K	Ref	PVPR
MiniEsférica Transparente	DIMMABLE TRIAC	G45	E27 6W 900Lm	3200K	3200K	BLED-390	6,78€
MiniEsférica Ambar	DIMMABLE TRIAC	G45	E27 6W 900Lm	3200K	3200K	BLED-391	7,14€
MiniEsférica Mate	DIMMABLE TRIAC	G45	E27 6W 900Lm	3200K	3200K	BLED-392	7,20€



SOLO REGULACIÓN TRIAC

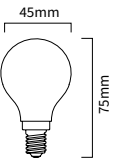

Mate Ambar Transparente

					°K	Ref	PVPR
Vintage Transparente	DIMMABLE TRIAC	A60	E27 10W 1300Lm	3200K	3200K	BLED-405	9,54€
Vintage Ambar	DIMMABLE TRIAC	A60	E27 10W 1300Lm	3200K	3200K	BLED-406	10,14€
Vintage Mate	DIMMABLE TRIAC	A60	E27 10W 1300Lm	3200K	3200K	BLED-407	10,26€



SOLO REGULACIÓN TRIAC

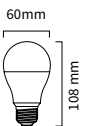

Ambar Transparente

					°K	Ref	PVPR
Vintage Edison Transparente	DIMMABLE TRIAC	ST64	E27 12W 1600Lm	3200K	3200K	BLED-408	13,44€
Vintage Edison Ambar	DIMMABLE TRIAC	ST64	E27 12W 1600Lm	3200K	3200K	BLED-409	14,40€



SOLO REGULACIÓN TRIAC

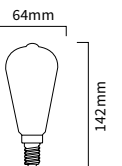



Blanco Ambar Transparente

					°K	Ref	PVPR
Vintage Globo Transparente	DIMMABLE TRIAC	G95	E27	12W	1700Lm	3200K	BLED-410 15,42€
Vintage Globo Ambar	DIMMABLE TRIAC	G95	E27	12W	1700Lm	3200K	BLED-411 16,56€
Vintage Globo Blanco	DIMMABLE TRIAC	G95	E27	12W	1700Lm	3200K	BLED-412 16,92€



**SOLO REGULACIÓN TRIAC**

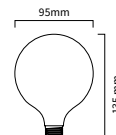

Opal Ambar Transparente

						°K	Ref	PVPR
Vintage Globo Transparente	DIMMABLE TRIAC	G125	E27	12W	1700Lm	3200K	BLED-413 17,64€	
Vintage Globo Ambar	DIMMABLE TRIAC	G125	E27	12W	1700Lm	3200K	BLED-414 18,96€	
Vintage Globo Blanco	DIMMABLE TRIAC	G125	E27	12W	1700Lm	3200K	BLED-415 19,26€	



**SOLO REGULACIÓN TRIAC**

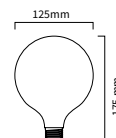

## Acabado de color de la lámpara



Mate Ambar Transparente

						°K	Ref	PVPR
Vintage Vela Transparente		C35	E14	4W	450Lm	2700K	BLED-161 5,73€	
Vintage Vela Transparente		C35	E14	4W	450Lm	4200K	BLED-162 5,73€	
Vintage Vela Transparente		C35	E14	4W	450Lm	5000K	BLED-163 5,73€	
Vintage Vela Ambar		C35	E14	4W	450Lm	3200K	BLED-164 6,60€	
Vintage Vela Mate		C35	E14	4W	450Lm	3200K	BLED-166 6,93€	
Vintage Vela Ambar	DIMMABLE TRIAC	C35	E14	4W	350Lm	3200K	BLED-165 10,05€	



BLED-165

**SOLO REGULACIÓN TRIAC**

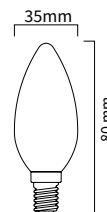

Mate Ambar Transparente

						°K	Ref	PVPR
Vintage Mini Esférica Transparente		G45	E14	4W	450Lm	2700K	BLED-167 5,67€	
Vintage Mini Esférica Transparente		G45	E14	4W	450Lm	4200K	BLED-168 5,67€	
Vintage Mini Esférica Transparente		G45	E14	4W	450Lm	5000K	BLED-169 5,67€	
Vintage Mini Esférica Ambar		G45	E14	4W	450Lm	3200K	BLED-173 6,93€	
Vintage Mini Esférica Mate		G45	E14	4W	400Lm	3200K	BLED-175 5,85€	

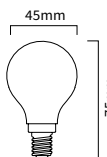

Mate Ambar Transparente

						°K	Ref	PVPR
Vintage Mini Esférica Transparente		G45	E27	4W	450Lm	2700K	BLED-170 5,16€	
Vintage Mini Esférica Transparente		G45	E27	4W	450Lm	4200K	BLED-171 5,67€	
Vintage Mini Esférica Transparente		G45	E27	4W	450Lm	5000K	BLED-172 5,67€	
Vintage Mini Esférica Ambar		G45	E27	4W	450Lm	3200K	BLED-174 6,93€	
Vintage Mini Esférica Mate		G45	E27	4W	400Lm	3200K	BLED-176 5,85€	

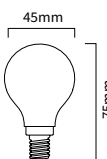

Mate Ambar Transparente

						°K	Ref	PVPR
Vintage Stand Transparente		A60	E27	8W	850Lm	2700K	BLED-177 7,89€	
Vintage Stand Transparente		A60	E27	8W	850Lm	4200K	BLED-178 7,89€	
Vintage Stand Transparente		A60	E27	8W	850Lm	5000K	BLED-179 7,89€	
Vintage Stand Ambar		A60	E27	8W	850Lm	3200K	BLED-237 9,21€	
Vintage Stand Mate		A60	E27	8W	850Lm	3200K	BLED-238 8,58€	

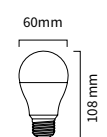

\* Según la nueva normativa ERP ha habido un cambio en la medición de Lúmenes y vatios, pero sigue emitiendo la misma cantidad de luz.

A medida que vayan entrando los nuevos modelos con ERP se irá actualizando en catálogo y cajas de color.

Puede haber variación respecto la caja del producto (comprobar en ficha técnica), todos los datos en catálogo están correctos salvo error tipográfico.



Ambar Transparente

			°K	Ref	PVPR
Vintage Edison Transparente	ST64	E27 8W	850Lm 2700K	BLED-180	9,60€
Vintage Edison Transparente	ST64	E27 8W	850Lm 4200K	BLED-181	9,60€
Vintage Edison Transparente	ST64	E27 8W	850Lm 5000K	BLED-182	9,60€
Vintage Edison Ambar	ST64	E27 8W	850Lm 3200K	BLED-183	10,77€

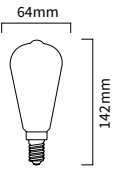

Opal Ambar Transparente

			°K	Ref	PVPR
Vintage Globo Transparente	100	G95 E27 8W	850Lm 2700K	BLED-184	10,65€
Vintage Globo Transparente	100	G95 E27 8W	850Lm 4200K	BLED-185	10,65€
Vintage Globo Transparente	100	G95 E27 8W	850Lm 5000K	BLED-186	10,65€
Vintage Globo Ambar	50	G95 E27 8W	850Lm 3200K	BLED-187	12,72€
Vintage Globo Opal	50	G95 E27 8W	850Lm 3000K	BLED-239	11,01€
Vintage Globo Opal	50	G95 E27 8W	850Lm 4000K	BLED-240	11,01€

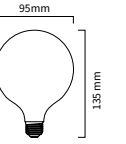

Opal Ambar Transparente

			°K	Ref	PVPR
Vintage Globo Transparente	G125	E27 8W	850Lm 2700K	BLED-188	13,92€
Vintage Globo Transparente	G125	E27 8W	850Lm 4200K	BLED-189	13,92€
Vintage Globo Transparente	G125	E27 8W	850Lm 5000K	BLED-190	13,92€
Vintage Globo Ambar	G125	E27 8W	850Lm 3200K	BLED-191	15,24€
Vintage Globo Ambar DIMMABLE TRIAC	G125	E27 8W	850Lm 3200K	BLED-192	16,92€
Vintage Globo Opal	G125	E27 8W	850Lm 3200K	BLED-241	14,13€
Vintage Globo Opal	G125	E27 8W	850Lm 4200K	BLED-242	14,13€



**BLED-192**  
**SOLO REGULACIÓN TRIAC**  
pág.37

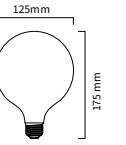

Opal Transparente

			°K	Ref	PVPR
Vintage Stand Transparente	A70	E27 17W	2452Lm 3200K	BLED-257	19,74€
Vintage Stand Transparente	A70	E27 17W	2452Lm 4200K	BLED-258	19,74€
Vintage Stand Transparente <b>NEW!</b>	A70	E27 17W	2452Lm 5000K	BLED-261	19,74€
Vintage Stand Opal	A70	E27 17W	2452Lm 3200K	BLED-259	20,64€
Vintage Stand Opal	A70	E27 17W	2452Lm 4200K	BLED-260	20,64€

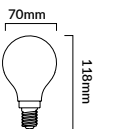

## Vela



			°K	Ref	PVPR
Vela Samsung Led	E14	6W	540Lm 3200K	BLED-216	2,97€
Vela Samsung Led	E14	6W	540Lm 4200K	BLED-217	2,97€
Vela Samsung Led	E14	6W	540Lm 5000K	BLED-218	2,97€

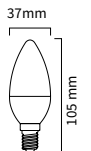

			°K	Ref	PVPR
Vela Samsung Led DIMMABLE TRIAC	E14	7W	630Lm 3200K	BLED-232	6,24€
Vela Samsung Led DIMMABLE TRIAC	E14	7W	630Lm 4200K	BLED-233	6,24€
Vela Samsung Led DIMMABLE TRIAC	E14	7W	630Lm 5000K	BLED-234	6,24€



**SOLO REGULACIÓN TRIAC**  
pág.37

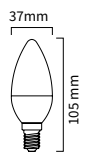



## Serie SAMSUNG LED Inside



### MiniEsférica

Used  
SAMSUNG  
LED Chips



			°K	Ref	PVPR
Miniesférica Samsung led	G45	E14 6W	470Lm	3200K	BLED-203 2,88€
Miniesférica Samsung led	G45	E14 6W	470Lm	4200K	BLED-204 2,88€
Miniesférica Samsung led	G45	E14 6W	470Lm	5000K	BLED-205 2,88€
Miniesférica Samsung led DIMMABLE TRIAC	G45	E14 6W	540Lm	3200K	BLED-255 7,05€
Miniesférica SMD led DIMMABLE TRIAC	G45	E14 6W	540Lm	4200K	BLED-100 7,05€
Miniesférica Samsung led	G45	E27 6W	540Lm	3200K	BLED-206 2,88€
Miniesférica Samsung led	G45	E27 6W	540Lm	4200K	BLED-207 2,88€
Miniesférica Samsung led	G45	E27 6W	540Lm	5000K	BLED-208 2,88€
Miniesférica SMD led DIMMABLE TRIAC	G45	E27 6W	540Lm	3200K	BLED-256 7,05€
Miniesférica SMD led DIMMABLE TRIAC	G45	E27 6W	540Lm	4200K	BLED-101 7,05€

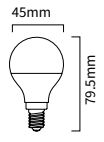

Used  
SAMSUNG  
LED Chips



6w 160° 230v >0,7 FP IP 40 100 BLED-255/100/256/101 SOLO REGULACIÓN TRIAC pág.37

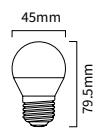

### Standar

Used  
SAMSUNG  
LED Chips



				°K	Ref	PVPR
Standar Samsung led DIMMABLE TRIAC	220°	A60	E27 10W	810Lm	3200K	BLED-235 13,86€
Standar Samsung led DIMMABLE TRIAC	220°	A60	E27 10W	810Lm	4200K	BLED-226 13,86€
Standar Samsung led DIMMABLE TRIAC	220°	A60	E27 10W	810Lm	5000K	BLED-236 13,86€
Standar Samsung led	160°	A60	E27 10W	930Lm	3200K	BLED-209 4,53€
Standar Samsung led	160°	A60	E27 10W	930Lm	4200K	BLED-210 4,53€
Standar Samsung led	160°	A60	E27 10W	930Lm	5000K	BLED-211 4,53€
Standar Samsung led	240°	A60	E27 12W	1200Lm	3200K	BLED-212 5,79€
Standar Samsung led	240°	A60	E27 12W	1200Lm	4200K	BLED-213 5,79€
Standar Samsung led	240°	A60	E27 12W	1200Lm	5000K	BLED-214 5,79€
Standar Samsung led	160°	A60	E27 14W	1500Lm	3200K	BLED-060 6,15€
Standar Samsung led	160°	A60	E27 14W	1500Lm	4200K	BLED-075 6,15€
Standar Samsung led	160°	A60	E27 14W	1500Lm	5000K	BLED-061 6,15€
Standar Samsung led	160°	A65	E27 17W	1900Lm	3200K	BLED-130 14,49€
Standar Samsung led	160°	A65	E27 17W	1900Lm	4200K	BLED-076 14,49€
Standar Samsung led	160°	A65	E27 17W	1900Lm	5000K	BLED-077 14,49€

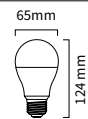
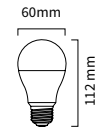
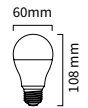

E27 10w 12w 14w 17w >0,9 FP 230v IP 40 100 BLED-235/226/236 SOLO REGULACIÓN TRIAC pág.37

NEW PRICE!!



### Stand Led sensor



Con sensor crepuscular solar

				°K	Ref	PVPR
Standar Led sensor crepuscular	A65	E27 12W	1200Lm	5000K	BLED-129	16,59€

E27 12w 1200 Lm 200° 230v >0,9 FP IP 40 100 SENSOR DE LUZ

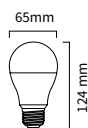

Con sensor de movimiento

				°K	Ref	PVPR
Stand Led sensor movimiento	A60	E27 12W	1200Lm	5000K	BLED-160	20,85€

E27 12w 1200 Lm 200° 230v >0,5 FP IP 20 100 SENSOR PIR DE MOVIMIENTO

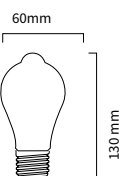

\* Según la nueva normativa ERP ha habido un cambio en la medición de Lúmenes y vatios, pero sigue emitiendo la misma cantidad de luz. A medida que vayan entrando los nuevos modelos con ERP se irá actualizando en catálogo y cajas de color. Puede haber variación respecto a la caja del producto (comprobar en ficha técnica), todos los datos en catálogo están correctos salvo error tipográfico.

Bombilla standard 5CCT

2700K 3200K 4000K 5000K 6500K

**5 en 1 CINCO TIPOS DE LUZ EN LA MISMA LUMINARIA**



**NEW!**

	Ref	PVPR
STANDARD A60 E27 11W	1100lm 5CCT	BLED-417 4,68€
STANDARD A60 E27 13W	1300lm 5CCT	BLED-418 5,64€
STANDARD A60 E27 16W	1600lm 5CCT	BLED-419 5,94€

60mm  
112mm

A60 E27 11w 13w 16w 180° 230v >0,5 FP IP 40 100

1100 Lm 1300 Lm 1600 Lm

SWITCH 5CCT GIRATORIO

CREA EL AMBIENTE PERFECTO  
**FÁCIL CAMBIO DE COLOR**

**NEW!**

**+ Lúmenes - Consumo**

	Ref	PVPR
STANDARD A65 E27 11W	1500lm 5CCT	BLED-273 6,45€

65mm  
124mm

A65 E27 11w 1500 Lm 180° 230v >0,5 FP IP 20 100



## Bombillas con batería integrada

Ideal para cualquier situación

### Bombilla led con batería integrada.

• Incluye gancho y adaptador de carga

• **Luz durante apagones:** La batería integrada asegura iluminación incluso cuando hay cortes de energía.

• **Fácil instalación:** Se usa como una bombilla o dicroica convencional, sin necesidad de instalaciones adicionales.



Batería Li-ion  
**1600mAh** Lm emergencia  
**240Lm**  
**1h de autonomía**

	K	Ref	PVPR
BOMBILLA CON BATERÍA 7W E27 200°	5000K	BLED-270	11,40€



Consultar instrucciones en ficha técnica para características de uso

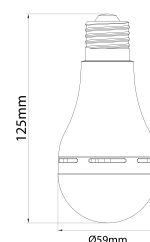

### Dicroica led con batería integrada.



Batería Li-ion  
**500mAh** Lm emergencia  
**60Lm**  
**1h de autonomía**

	K	Ref	PVPR
DICROICA CON BATERÍA 5W GU10 60°	4200K	DIC-110	13,56€



Consultar instrucciones en ficha técnica para características de uso



Batería integrada alta duración  
500mAh

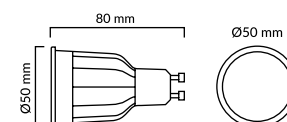

\* Según la nueva normativa ERP ha habido un cambio en la medición de Lúmenes y vatios, pero sigue emitiendo la misma cantidad de luz. A medida que vayan entrando los nuevos modelos con ERP se irá actualizando en catálogo y cajas de color. Puede haber variación respecto a la caja del producto (comprobar en ficha técnica), todos los datos en catálogo están correctos salvo error tipográfico.

# Lámparas Standar led **LUMILEDS**

**ALTA DURABILIDAD - ALTA EFICIENCIA**  
**ALTA RESISTENCIA IP65**



Instalar únicamente en posición vertical

				°K		Ref	PVPR
Standar led Lumileds	20	A80	E27 30W	3200Lm	3200K	BLED-113	26,85€
Standar led Lumileds	20	A80	E27 30W	3200Lm	4200K	BLED-108	26,85€
Standar led Lumileds	20	A80	E27 30W	3200Lm	5000K	BLED-109	26,85€
Standar led Lumileds	20	A100	E27 45W	4200Lm	3200K	BLED-114	39,78€
Standar led Lumileds	20	A100	E27 45W	4200Lm	4200K	BLED-106	39,78€
Standar led Lumileds	20	A100	E27 45W	4200Lm	5000K	BLED-107	39,78€
Standar led Lumileds	12	A120	E27 60W	6500Lm	3200K	BLED-115	64,17€
Standar led Lumileds	12	A120	E27 60W	6500Lm	4200K	BLED-104	64,17€
Standar led Lumileds	12	A120	E27 60W	6500Lm	5000K	BLED-105	64,17€

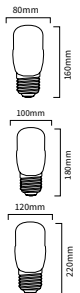

Instalar únicamente en posición vertical - INCLUYE ADAPTADOR E40-E27

					°K	Ref	PVPR
Standar led Lumileds		A160	E40 80W	8720Lm	3200K	BLED-225	92,16€
Standar led Lumileds		A160	E40 80W	8720Lm	4200K	BLED-135	92,16€
Standar led Lumileds		A160	E40 80W	8720Lm	5000K	BLED-103	92,16€

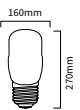



## Tulip



Accepta cualquier posición de instalación

			°K	Ref	PVPR
Stand led SMD Tulip	360° A100	E27 40W	3600Lm	3200K	BLED-224 39,57€
Stand led SMD Tulip	360° A100	E27 40W	3600Lm	4200K	BLED-148 39,57€
Stand led SMD Tulip	360° A100	E27 40W	3600Lm	5000K	BLED-149 39,57€



Used SAMSUNG LED Chips

Stand led SMD Tulip	300° A100	E27 60W	6500Lm	4200K	BLED-243 70,98€
Stand led SMD Tulip	300° A100	E27 60W	6500Lm	5000K	BLED-244 70,98€

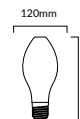

## Globo



				°K	Ref	PVPR
Globo led	G80	E27 12W	1200Lm	3200K	BLED-078	10,47€
Globo led	G80	E27 12W	1200Lm	4200K	BLED-079	10,47€
Globo led	G80	E27 12W	1200Lm	5000K	BLED-080	10,47€
Globo led	G95	E27 15W	1500Lm	3200K	BLED-081	13,32€
Globo led	G95	E27 15W	1500Lm	4200K	BLED-082	13,32€
Globo led	G95	E27 15W	1500Lm	5000K	BLED-083	13,32€
Globo led	G120	E27 18W	1700Lm	3200K	BLED-084	20,16€
Globo led	G120	E27 18W	1700Lm	4200K	BLED-085	20,16€
Globo led	G120	E27 18W	1700Lm	5000K	BLED-086	20,16€

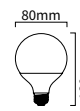

## Reflectora E14



NEW PRICE!!

				°K	Ref	PVPR
Reflectora R50	R50	E14 5W	400Lm	3200K	BLED-093	5,28€
Reflectora R50	R50	E14 5W	400Lm	4200K	BLED-131	5,28€
Reflectora R50	R50	E14 5W	400Lm	5000K	BLED-097	5,28€

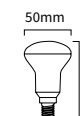

## Reflectora E27



NEW PRICE!!

				°K	Ref	PVPR
Reflectora R63	R63	E27 8W	720Lm	3200K	BLED-094	5,73€
Reflectora R63	R63	E27 8W	720Lm	4200K	BLED-132	5,73€
Reflectora R63	R63	E27 8W	720Lm	5000K	BLED-098	5,73€
Reflectora R80	R80	E27 10W	950Lm	3200K	BLED-095	6,33€
Reflectora R80	R80	E27 10W	950Lm	4200K	BLED-133	6,33€
Reflectora R80	R80	E27 10W	950Lm	5000K	BLED-116	6,33€
Reflectora R90	R90	E27 12W	1000Lm	3200K	BLED-096	6,90€
Reflectora R90	R90	E27 12W	1000Lm	4200K	BLED-134	6,90€
Reflectora R90	R90	E27 12W	1000Lm	5000K	BLED-099	6,90€

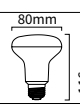
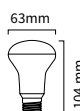

## Lámpara T7



				°K	Ref	PVPR
Lámpara T7	T7	E14 9W	750Lm	3200K	BLED-141	6,99€
Lámpara T7	T7	E14 9W	750Lm	4200K	BLED-142	6,99€
Lámpara T7	T7	E14 9W	750Lm	5000K	BLED-143	6,99€
Lámpara T7	T7	E27 9W	750Lm	3200K	BLED-144	6,99€
Lámpara T7	T7	E27 9W	750Lm	4200K	BLED-145	6,99€
Lámpara T7	T7	E27 9W	750Lm	5000K	BLED-146	6,99€

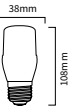
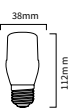

\* Según la nueva normativa ERP ha habido un cambio en la medición de Lúmenes y vatios, pero sigue emitiendo la misma cantidad de luz.

A medida que vayan entrando los nuevos modelos con ERP se irá actualizando en catálogo y cajas de color.

Puede haber variación respecto a la caja del producto (comprobar en ficha técnica), todos los datos en catálogo están correctos salvo error tipográfico.

# Reflectora 3CCT

**3 en 1 TRES TIPOS DE LUZ**  
EN LA MISMA LUMINARIA



Switch  
**3CCT**



SWITCH 5CCT  
INTERRUPTOR

	°K	Ref	PVPR
REFLECTORA R90 12W	E27 3CCT	BLED-274	7,74€

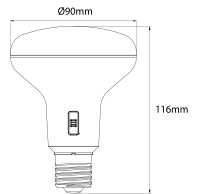

## PAR 30



			°K	Ref	PVPR
PAR30		<i>E27 10w 800lm</i>	3200K	BLED-118	13,74€
PAR30		<i>E27 10w 800lm</i>	4200K	BLED-119	13,74€
PAR30		<i>E27 10w 800lm</i>	5000K	BLED-120	13,74€

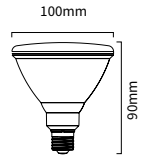

			°K	Ref	PVPR
PAR30	BLANCO	<i>E27 20w 1900lm</i>	3200K	BLED-249	32,34€
PAR30	BLANCO	<i>E27 20w 1900lm</i>	4200K	BLED-250	32,34€
PAR30	BLANCO	<i>E27 20w 1900lm</i>	5000K	BLED-251	32,34€

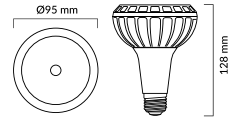
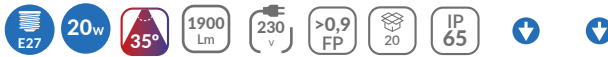

PAR30	NEGRO	<i>E27 20w 1900lm</i>	3200K	BLED-252	32,34€
PAR30	NEGRO	<i>E27 20w 1900lm</i>	4200K	BLED-253	32,34€
PAR30	NEGRO	<i>E27 20w 1900lm</i>	5000K	BLED-254	32,34€



			°K	Ref	PVPR
PAR30	BLANCO	<i>E27 28w 2600lm</i>	3200K	BLED-110	62,97€
PAR30	BLANCO	<i>E27 28w 2600lm</i>	4200K	BLED-111	62,97€
PAR30	BLANCO	<i>E27 28w 2600lm</i>	5000K	BLED-112	62,97€
PAR30	NEGRO	<i>E27 28w 2600lm</i>	3200K	BLED-138	62,97€
PAR30	NEGRO	<i>E27 28w 2600lm</i>	4200K	BLED-139	62,97€
PAR30	NEGRO	<i>E27 28w 2600lm</i>	5000K	BLED-140	62,97€

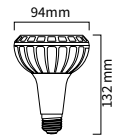

			K°	Ref	PVPR
PAR30	BLANCO	<i>E27 30w 2600lm</i>	3200K	BLED-416	34,62€
PAR30	BLANCO	<i>E27 30w 2600lm</i>	4200K	BLED-420	34,62€

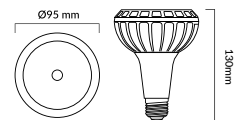

			K°	Ref	PVPR
PAR30	NEGRO	<i>E27 30w 2600lm</i>	3200K	BLED-421	34,62€
PAR30	NEGRO	<i>E27 30w 2600lm</i>	4200K	BLED-422	34,62€

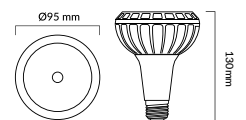

# PAR38 E27

NEW!



SWITCH 5CCT GIRATORIO

## 5 en 1 CINCO TIPOS DE LUZ EN LA MISMA LUMINARIA

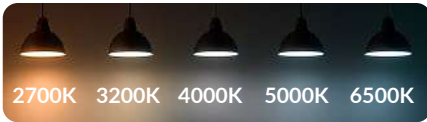

PAR38 E27 15W	E27	5CCT	°K	Ref
				BLED-272



Compatible con picas de jardin

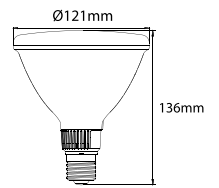

NEW!



SWITCH 3CCT INTERRUPTOR

## 3 en 1 TRES TIPOS DE LUZ EN LA MISMA LUMINARIA



PAR38 E27 15W	1400lm	3CCT	K	Ref	PVPR
				BLED-117	22,83€



Compatible con picas de jardin

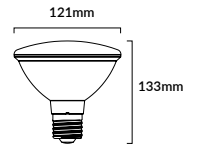

### PAR 38 Monocolor



Monocolor			K°	Ref	PVPR
PAR38	BLANCO	E27 15w   200lm	3200K	BLED-121	20,91€
PAR38	BLANCO	E27 15w   200lm	4200K	BLED-122	20,91€
PAR38	BLANCO	E27 15w   200lm	5000K	BLED-123	20,91€
PAR38	NEGRO	E27 15w   200lm	3200K	BLED-124	20,91€
PAR38	NEGRO	E27 15w   200lm	5000K	BLED-125	20,91€

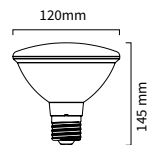

NEW PRICE!!



### Colores independientes

PAR38	BLACK BODY	E27 15w   200lm	VERDE	BLED-126	18,06€
PAR38	BLACK BODY	E27 15w   200lm	AZUL	BLED-127	20,91€
PAR38	BLACK BODY	E27 15w   200lm	ROJO	BLED-128	20,91€

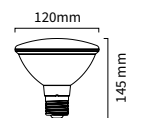

## Serie QR111

**NEW PRICE!!**



		°K	Ref	PVPR
QR111 LED SMD	20 GUI0 12W 1100Lm	2700K	QR-026	23,85€
QR111 LED SMD	20 GUI0 12W 1100Lm	3200K	QR-017	18,45€
QR111 LED SMD	20 GUI0 12W 1100Lm	4200K	QR-018	18,45€
QR111 LED SMD	20 GUI0 12W 1100Lm	5000K	QR-019	18,45€
QR111 LED SMD DIMMABLE TRIAC	50 GUI0 12W 1100Lm	3200K	QR-024	35,94€
QR111 LED SMD DIMMABLE TRIAC	50 GUI0 12W 1100Lm	4200K	QR-023	35,94€
QR111 LED SMD DIMMABLE TRIAC	50 GUI0 12W 1100Lm	5000K	QR-025	35,94€

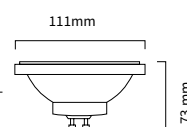

pág.37

**NEW!**



		°K	Ref	PVPR
QR111 LED SMD	GUI0 18W 1700Lm	3200K	QR-027	22,44€
QR111 LED SMD	GUI0 18W 1700Lm	4200K	QR-028	22,44€

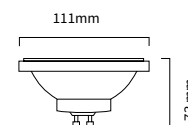

Used **SAMSUNG** LED Chips



		°K	Ref	PVPR
MÓDULO QR111 LED COB	30W 3000Lm	3200K	QR-014	75,84€
MÓDULO QR111 LED COB	30W 3000Lm	4200K	QR-015	75,84€
MÓDULO QR111 LED COB	30W 3000Lm	5000K	QR-016	75,84€

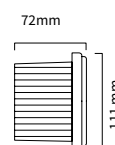

**NEW PRICE!!**



		°K	Ref	PVPR
QR111 LED SMD 12V	G53 12W 1000Lm	3200K	QR-020	21,69
QR111 LED SMD 12V	G53 12W 1000Lm	4200K	QR-021	21,69
QR111 LED SMD 12V	G53 12W 1000Lm	5000K	QR-022	21,69

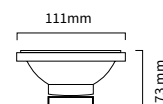

Sólo disponible para instalaciones de QR111 y Dicroica 12v

		Ref	PVPR
Alimentador Meanwell	LRS-100-12 100W	ALM-026	63,81€
Alimentador Meanwell	LRS-100-12 200W	ALM-027	133,08€
Alimentador Meanwell	LRS-100-12 350W	ALM-028	157,83€



\* Según la nueva normativa ERP ha habido un cambio en la medición de Lúmenes y vatios, pero sigue emitiendo la misma cantidad de luz.

A medida que vayan entrando los nuevos modelos con ERP se irá actualizando en catálogo y cajas de color.

Puede haber variación respecto a la caja del producto (comprobar en ficha técnica), todos los datos en catálogo están correctos salvo error tipográfico.

## Serie Dicroicas

ALTA CALIDAD - ALTO RENDIMIENTO

Dicroica led con batería integrada.



1h de autonomía

Batería Li-ion  
500mAh

Lm emergencia  
60Lm

	K	Ref	PVPR
DICROICA CON BATERÍA 5W GU10 60°	4200K	DIC-110	13,56€



Consultar instrucciones en ficha técnica para características de uso



Batería integrada  
alta duración  
500mAh

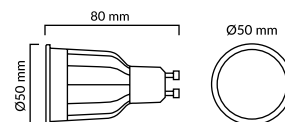

### Dicroicas GU10

Used SAMSUNG LED Chips



Dicroica LED SAMSUNG	GUI0 6W 480Lm	2700K	DIC-086	3,21€
Dicroica LED SAMSUNG	GUI0 6W 510Lm	3200K	DIC-087	3,21€
Dicroica LED SAMSUNG	GUI0 6W 510Lm	4200K	DIC-088	3,21€
Dicroica LED SAMSUNG	GUI0 6W 510Lm	5000K	DIC-089	3,21€

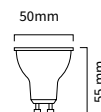

Used SAMSUNG LED Chips



Dicroica LED SAMSUNG	GUI0 6W 540Lm	3200K	DIC-091	3,21€
Dicroica LED SAMSUNG	GUI0 6W 540Lm	4200K	DIC-092	3,21€
Dicroica LED SAMSUNG	GUI0 6W 540Lm	5000K	DIC-093	3,21€

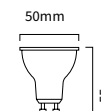

Dicroica LED SMD	GUI0 6,5W 590Lm	3200K	DIC-068	4,86€
Dicroica LED SMD	GUI0 6,5W 590Lm	4200K	DIC-069	4,86€
Dicroica LED SMD	GUI0 6,5W 590Lm	5000K	DIC-070	4,86€

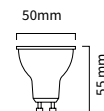



Dicroica LED SMD	GUI0 8W 700Lm	2700K	DIC-083	6,15€
Dicroica LED SMD	GUI0 8W 700Lm	3200K	DIC-071	6,15€
Dicroica LED SMD	GUI0 8W 700Lm	4200K	DIC-072	6,15€
Dicroica LED SMD	GUI0 8W 700Lm	5000K	DIC-073	6,15€
Dicroica LED SMD DIMMABLE TRIAC	GUI0 8W 700Lm	2700K	DIC-104	9,96€
Dicroica LED SMD DIMMABLE TRIAC	GUI0 8W 700Lm	3200K	DIC-081	9,96€
Dicroica LED SMD DIMMABLE TRIAC	GUI0 8W 700Lm	4200K	DIC-064	9,96€
Dicroica LED SMD DIMMABLE TRIAC	GUI0 8W 700Lm	5000K	DIC-082	9,96€

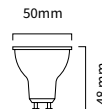
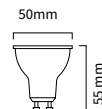

**DIC-081/064/082**  
**SOLO REGULACIÓN TRIAC**  
 pág.37



Dicroica LED SMD	GUI0 9W 920Lm	3200K	DIC-061	10,44€
Dicroica LED SMD	GUI0 9W 920Lm	4200K	DIC-062	10,44€
Dicroica LED SMD	GUI0 9W 920Lm	5000K	DIC-063	10,44€

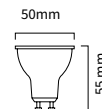

Dicroica LED SMD	GUI0 9W 1100Lm	3200K	DIC-066	14,40€
Dicroica LED SMD	GUI0 9W 1100Lm	4200K	DIC-077	14,40€
Dicroica LED SMD	GUI0 9W 1100Lm	5000K	DIC-067	14,40€
Dicroica LED SMD DIMMABLE TRIAC	GUI0 9W 1100Lm	3200K	DIC-084	17,91€
Dicroica LED SMD DIMMABLE TRIAC	GUI0 9W 1100Lm	4200K	DIC-065	17,91€
Dicroica LED SMD DIMMABLE TRIAC	GUI0 9W 1100Lm	5000K	DIC-085	17,91€

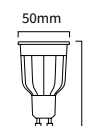

**DIC-084/065/085**  
**SOLO REGULACIÓN TRIAC**  
 pág.37



		°K	Ref	PVPR
Dicroica LED SMD 12V	MR16 8W 590Lm	3200K	DIC-074	7,05€
Dicroica LED SMD 12V	MR16 8W 590Lm	4200K	DIC-075	7,05€
Dicroica LED SMD 12V	MR16 8W 590Lm	5000K	DIC-076	7,05€

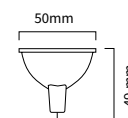

Sólo disponible para instalaciones de QR111 y Dicroica 12v

		°K	Ref	PVPR
Alimentador Meanwell	LRS-100-12 100W		ALM-026	63,81€
Alimentador Meanwell	LRS-100-12 200W		ALM-027	133,08€
Alimentador Meanwell	LRS-100-12 350W		ALM-028	157,83€



### Módulo Dicroica

Usado  
**CREE**  
LED Chips



		°K	Ref	PVPR
Módulo 15w Dicroica	15W 1500Lm	3200K	DIC-078	54,00€
Módulo 15w Dicroica	15W 1500Lm	5000K	DIC-080	54,00€

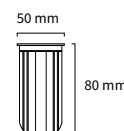

### Portalamparas



Portalámparas cerámico	GUI0	PORTLM-002	0,66€
------------------------	------	------------	-------

\* Según la nueva normativa ERP ha habido un cambio en la medición de Lúmenes y vatios, pero sigue emitiendo la misma cantidad de luz.

A medida que vayan entrando los nuevos modelos con ERP se irá actualizando en catálogo y cajas de color.

Puede haber variación respecto la caja del producto (comprobar en ficha técnica), todos los datos en catálogo están correctos salvo error tipográfico.

- Módulo 3CCT
- Dicroicas 3CCT

## Módulo Dicroica 3CCT



3 en 1

TRES TIPOS DE LUZ  
EN LA MISMA LUMINARIA



Switch  
3CCT



MÓDULO LED 3CCT		Ref	PVPR
Blanco 3CCT		DIC-097	7,80€

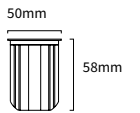

## Dicroica 3CCT



DICROICA LED 7W GU10 3CCT 60°		Ref	PVPR
3CCT		DIC-094	3,96€

>0,5 FP icon"/>

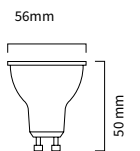



## Serie módulo Techos bajos

**3 en 1 TRES TIPOS DE LUZ**  
EN LA MISMA LUMINARIA



Switch  
**3CCT**



**NEW!**

DICROICA ESPECIAL **TECHOS BAJOS**

**MINILIGHT LED COMPACTA CON CABLE**



AROS  
INTERCAMBIABLES

Ref **PVPR**

**3CCT** DIC-096 3,93€

Corte  
Ø35mm

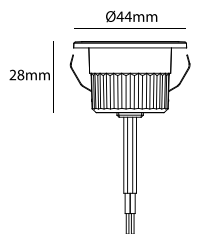

**INSTALACIÓN DIRECTA POR PRESIÓN - NO NECESITA ARO**



**NEW!**

DICROICA ESPECIAL **TECHOS BAJOS**

**DICROICA LED COMPACTA CON CABLE**



Ref **PVPR**

**3CCT** DIC-095 6,48€

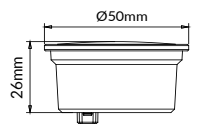

**NEW!**

DICROICA ESPECIAL **TECHOS BAJOS**

**DICROICA LED COMPACTA CON CABLE DIMMABLE**

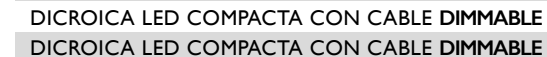

K Ref **PVPR**

**2700K** DIC-100 7,98€

**3200K** DIC-101 7,98€

**4200K** DIC-102 7,98€

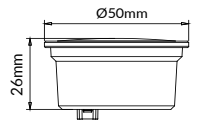

**SOLO REGULACIÓN TRIAC**  
pág.37

## Ideal para espacios reducidos

donde no caben bombillas GU10

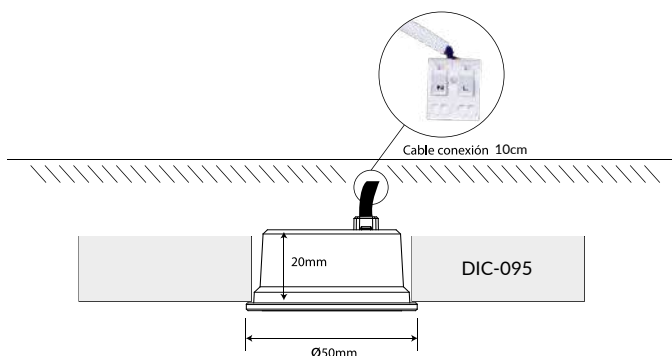

Ejemplo de instalación con ARO-053

\* Según la nueva normativa ERP ha habido un cambio en la medición de Lúmenes y vatios, pero sigue emitiendo la misma cantidad de luz. A medida que vayan entrando los nuevos modelos con ERP se irá actualizando en catálogo y cajas de color. Puede haber variación respecto a la caja del producto (comprobar en ficha técnica), todos los datos en catálogo están correctos salvo error tipográfico.



# SERIE MINILIGHT



ALUMINIO



Alta fidelidad en la  
reproducción de los  
colores

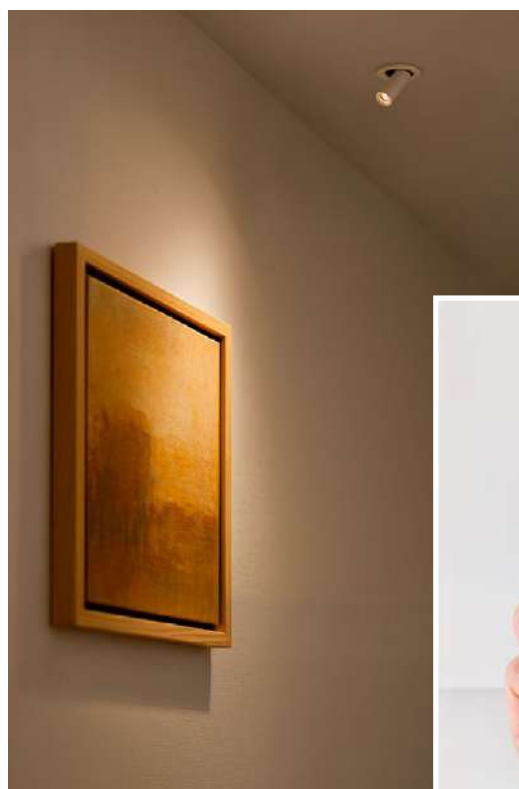

## Ventajas CRI90

- **Colores más reales y vivos**  
Reproduce los colores de forma más natural, como se verían bajo luz solar.  
Ideal para entornos donde la percepción del color es clave.
- **Mayor confort visual**  
Reduce la fatiga ocular y mejor la percepción general del entorno.
- **Mejora en presentación de productos**  
Los productos se ven más atractivos y fieles a su color original, aumentando las ventas.
- **Recomendado para normativas profesionales**  
En sectores como sanidad, arte, hostelería o cosmética se exige o recomienda un CRI alto.

# SERIE MINILIGHT



40.000 HORAS DE VIDA

LARGA VIDA UTIL



5 AÑOS GARANTÍA



NEW!

ALUMINIO



				Ref
MINILIGHT CIRCULAR 4W	Blanco	3CCT		DOW-385
MINILIGHT CIRCULAR 4W	Negro	3CCT		DOW-386



Corte Ø35mm

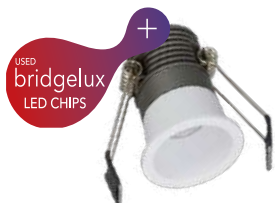
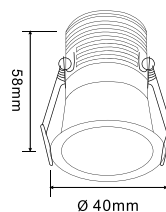

USED bridgelux LED CHIPS

— ACCESORIOS — (No incluido) —

LENTE INTERCAMBIABLE 24°

ACLED-262- 24°

CONTR-383 - DRIVER REGULABLE

3 en 1 TRES TIPOS DE LUZ EN LA MISMA LUMINARIA

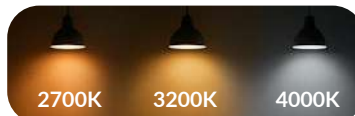

NEW!

ALUMINIO



				Ref
MINILIGHT CIRCULAR ORIENTABLE 5W	Blanco	3CCT		DOW-383
MINILIGHT CIRCULAR ORIENTABLE 5W	Negro	3CCT		DOW-384



Corte Ø45mm

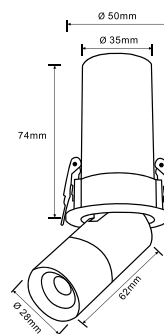

USED bridgelux LED CHIPS

— ACCESORIOS — (No incluido) —

LENTE INTERCAMBIABLE 15° - 24°

ACLED-260 - 15° / ACLED-261 - 24°

CONTR-383 - DRIVER REGULABLE

3 en 1 TRES TIPOS DE LUZ EN LA MISMA LUMINARIA

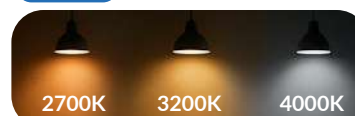

\* Según la nueva normativa ERP ha habido un cambio en la medición de Lúmenes y vatios, pero sigue emitiendo la misma cantidad de luz. A medida que vayan entrando los nuevos modelos con ERP se irá actualizando en catálogo y cajas de color. Puede haber variación respecto la caja del producto (comprobar en ficha técnica), todos los datos en catálogo están correctos salvo error tipográfico.

## Serie Aro Led Integrado

Used  
**SAMSUNG**  
LED Chips

 UGR<19

**3 en 1 TRES TIPOS DE LUZ**  
EN LA MISMA LUMINARIA



Switch  
**3CCT**



**DISPONIBLE MÓDULO LED DE SUSTITUCIÓN**



○ FORMA CIRCULAR

\* LED INTEGRADO

					K°	Ref	PVPR
DOWNLIGHT MINI	CIRCULAR <b>RECTO</b>	Blanco	8w	3CCT	DOW-324	11,52€	
DOWNLIGHT MINI	CIRCULAR <b>RECTO</b>	Negro	8w	3CCT	DOW-325	11,52€	

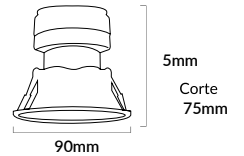

DOWNLIGHT MINI	CIRCULAR <b>ASIMÉTRICO</b>	Blanco	8w	3CCT	DOW-326	11,52€
DOWNLIGHT MINI	CIRCULAR <b>ASIMÉTRICO</b>	Negro	8w	3CCT	DOW-327	11,52€

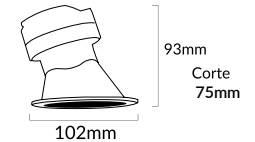

□ FORMA CUADRADO

\* LED INTEGRADO

DOWNLIGHT MINI	CUADRADO <b>RECTO</b>	Blanco	8w	3CCT	DOW-328	11,52€
DOWNLIGHT MINI	CUADRADO <b>RECTO</b>	Negro	8w	3CCT	DOW-329	11,52€

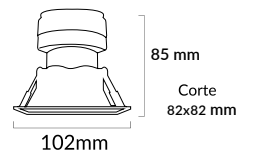

DOWNLIGHT MINI	CUADRADO <b>ASIMÉTRICO</b>	Blanco	8w	3CCT	DOW-330	11,52€
DOWNLIGHT MINI	CUADRADO <b>ASIMÉTRICO</b>	Negro	8w	3CCT	DOW-331	11,52€

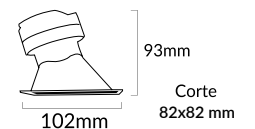



## Serie Aro Led Integrado

### SAMSUNG LED Inside

#### \* LED INTEGRADO



					K°	Ref	PVPR
DOWNLIGHT MINI	CIRCULAR ORIENTABLE 360°	Blanco	7w		3200K	DOW-342	8,55€
DOWNLIGHT MINI	CIRCULAR ORIENTABLE 360°	Blanco	7w		4200K	DOW-343	8,55€
DOWNLIGHT MINI	CIRCULAR ORIENTABLE 360°	Blanco	7w		5000K	DOW-344	8,55€

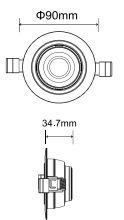

#### \* LED INTEGRADO



					K°	Ref	PVPR
DOWNLIGHT MINI	CUADRADO ORIENTABLE 360°	Blanco	7w		3200K	DOW-345	8,70€
DOWNLIGHT MINI	CUADRADO ORIENTABLE 360°	Blanco	7w		4200K	DOW-346	8,70€
DOWNLIGHT MINI	CUADRADO ORIENTABLE 360°	Blanco	7w		5000K	DOW-347	8,70€

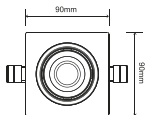

Used  
**SAMSUNG**  
LED Chips



## Serie G9 y lineales

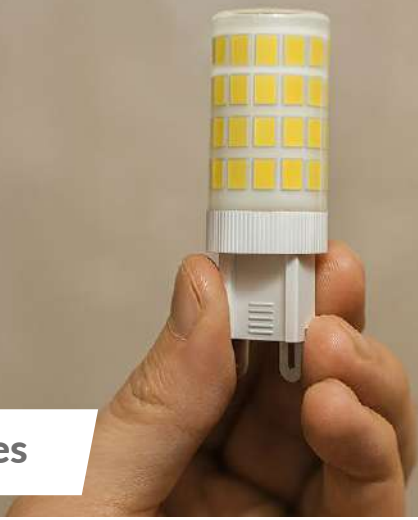

Para Downlights - CASQUILLO ROTATORIO

				°K		Ref	PVPR
Lámpara PL	G24 2PIN 9W	800Lm		3200K	☀	BLED-147	14,25€
Lámpara PL	G24 2PIN 9W	800Lm		4200K	☁	BLED-136	12,30€
Lámpara PL	G24 2PIN 9W	800Lm		5000K	☀	BLED-137	12,30€

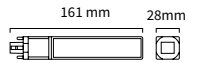

				°K		Ref	PVPR	
Lámpara Mini	12V	100	G4 1.2W	100Lm	3200K	☀	BLED-360	4,14€
Lámpara Mini	12V	100	G4 1.2W	100Lm	5000K	☀	BLED-361	4,14€

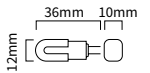

OSRAM  
LED Chips



					°K		Ref	PVPR
Lámpara	12V	G4 2W	200Lm		3200K	☀	BLED-199	4,47€
Lámpara	12V	G4 2W	200Lm		4200K	☁	BLED-200	4,47€
Lámpara	12V	G4 2W	200Lm		5000K	☀	BLED-201	4,47€
Lámpara	230V	G9 3W	300Lm		3200K	☀	BLED-193	2,49€
Lámpara	230V	G9 3W	300Lm		4200K	☁	BLED-194	2,49€
Lámpara	230V	G9 3W	300Lm		5000K	☀	BLED-195	2,49€
Lámpara	230V	G9 4W	380Lm		3200K	☀	BLED-196	3,09€
Lámpara	230V	G9 4W	380Lm		4200K	☁	BLED-197	3,09€
Lámpara	230V	G9 4W	380Lm		5000K	☀	BLED-198	3,09€

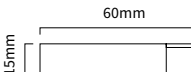
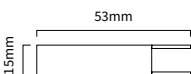

					°K		Ref	PVPR
Lámpara LED Mini	G9	2,5W	220Lm		3200K	☀	BLED-356	4,92€
Lámpara LED Mini	G9	2,5W	220Lm		5000K	☀	BLED-357	4,92€
Lámpara LED Mini	G9	3W	300Lm		3200K	☀	BLED-358	6,06€
Lámpara LED Mini	G9	3W	300Lm		5000K	☀	BLED-359	6,06€

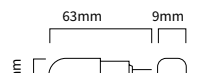
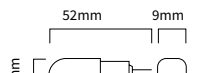



			°K	Ref	PVPR
Lámpara LED Mini DIMMABLE TRIAC	G9 3.5w	370lm	4200K	BLED-202	9,06€
Lámpara LED Mini DIMMABLE TRIAC	G9 3.5w	370lm	5000K	BLED-072	9,06€



**SOLO REGULACIÓN TRIAC**

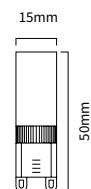

			°K	Ref	PVPR
Lámpara LED COB	G9 4w	400lm	3200K	BLED-229	7,17€
Lámpara LED COB	G9 4w	400lm	4200K	BLED-230	7,17€
Lámpara LED COB	G9 4w	400lm	5000K	BLED-231	7,17€



**ALTA LUMINOSIDAD**



			°K	Ref	PVPR
Lámpara LED Alta luminosidad	G9 4.5w	530lm	3200K	BLED-246	5,61€
Lámpara LED Alta luminosidad	G9 4.5w	530lm	4200K	BLED-247	5,61€
Lámpara LED Alta luminosidad	G9 4.5w	530lm	5000K	BLED-248	5,61€



5w

				°K	Ref	PVPR
Lineal Slim Led	78mm R7S	5w 450lm	3200K	LIN-013	13,74€	
Lineal Slim Led	78mm R7S	5w 450lm	4200K	LIN-014	13,74€	
Lineal Slim Led	78mm R7S	5w 450lm	5000K	LIN-015	13,74€	

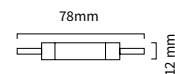

8w

Lineal Slim Led	118mm R7S	8w 800lm	3200K	LIN-016	15,54€
Lineal Slim Led	118mm R7S	8w 800lm	4200K	LIN-017	15,54€
Lineal Slim Led	118mm R7S	8w 800lm	5000K	LIN-018	15,54€

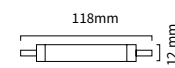

10w

				°K	Ref	PVPR
Lineal Led DIMMABLE TRIAC	78mm R7S	10w 1100lm	3200K	LIN-019	23,37€	
Lineal Led DIMMABLE TRIAC	78mm R7S	10w 1100lm	4200K	LIN-020	23,37€	
Lineal Led DIMMABLE TRIAC	78mm R7S	10w 1100lm	5000K	LIN-021	23,37€	

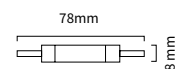

14w

Lineal Slim Led DIMMABLE TRIAC	118mm R7S	14w 2000lm	3200K	LIN-022	26,55€
Lineal Slim Led DIMMABLE TRIAC	118mm R7S	14w 2000lm	4200K	LIN-023	26,55€
Lineal Slim Led DIMMABLE TRIAC	118mm R7S	14w 2000lm	5000K	LIN-024	26,55€

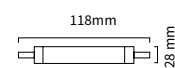

**SOLO REGULACIÓN TRIAC**



6w

				°K	Ref	PVPR
Lineal Slim Led COB	78mm R7S	6w 500lm	3200K	LIN-025	12,66€	
Lineal Slim Led COB	78mm R7S	6w 500lm	4200K	LIN-026	12,66€	
Lineal Slim Led COB	78mm R7S	6w 500lm	5000K	LIN-027	12,66€	

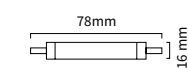

10w

Lineal Slim Led COB	118mm R7S	10w 1300lm	3200K	LIN-028	16,26€
Lineal Slim Led COB	118mm R7S	10w 1300lm	4200K	LIN-029	16,26€
Lineal Slim Led COB	118mm R7S	10w 1300lm	5000K	LIN-030	16,26€

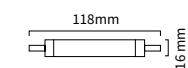

\* Según la nueva normativa ERP ha habido un cambio en la medición de Lúmenes y vatios, pero sigue emitiendo la misma cantidad de luz.

A medida que vayan entrando los nuevos modelos con ERP se irá actualizando en catálogo y cajas de color.

Puede haber variación respecto la caja del producto (comprobar en ficha técnica), todos los datos en catálogo están correctos salvo error tipográfico.

## Serie lámparas domóticas

COMPATIBLE  
CON APP  
**tuya**



**3 en 1 TRES TIPOS DE LUZ**  
EN LA MISMA LUMINARIA



	°K	Ref	PVPR
Dicroica Led WiFi DIMMABLE 🌞 <b>GU10 5W 400Lm</b> 📶 🌈 ⬇️		DIC-090	21,51€

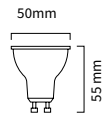

	°K	Ref	PVPR
Miniesférica Led WiFi DIMMABLE 🌞 <b>G45 E14 5W 470Lm</b> 📶 🌈 ⬇️		BLED-221	21,51€
Miniesférica Led WiFi DIMMABLE 🌞 <b>G45 E27 5W 470Lm</b> 📶 🌈 ⬇️		BLED-220	21,51€

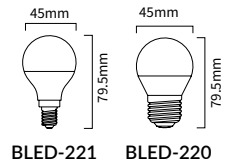

	°K	Ref	PVPR
Standar Led WiFi DIMMABLE 🌞 <b>A60 E27 10W 900Lm</b> 📶 🌈 ⬇️		BLED-219	21,51€

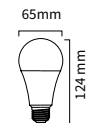

	°K	Ref	PVPR
Globo Led WiFi DIMMABLE 🌞 <b>G95 E27 11W 1055Lm</b> 📶 🌈 ⬇️		BLED-222	28,71€
Globo Led WiFi DIMMABLE 🌞 <b>G120 E27 15W 1520Lm</b> 📶 🌈 ⬇️		BLED-223	32,31€

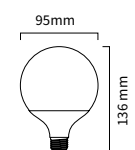



**Para interruptor simple, conmutado y cruce**



PASTILLA INTERRUPTOR MINI LED

WiFi 300W LED



Ref

PVPR

CONTR-054

41,91€

tuya

230 V -



**No apta para instalaciones conmutables**

PASTILLA INTERRUPTOR MINI MULTIFUNCIÓN

WiFi 300W LED



CONTR-082

29,85€

tuya

230 V -



**Para DOBLE interruptor, interruptor partido y conmutado**

PASTILLA DOBLE INTERRUPTOR LED

WiFi 2 X 150W



CONTR-042

56,31€

tuya

230 V -

Disponibles para varios pulsadores



**Para varios pulsadores REGULACIÓN TRIAC**



PASTILLA DIMMABLE TRIAC

WiFi 300W LED

WiFi 300W LED



CONTR-063

60,66€

tuya

230 V -



PASTILLA TELERRUPTOR MINI WiFi 16A 230V - 300W LED



CONTR-071

45,06€

tuya

230 V -

NEW!



**REGULACIÓN TRIAC DIMMABLE 0-100% SIN PARPADEO**



CONTROLADOR DIMMABLE TRIAC WiFi PULSADOR

WiFi 500W LED

CONTR-096

84,30€

tuya

230 V -

· CONEXIÓN WiFi, 2,4Ghz, BLUETOOTH / CONTROL REMOTO 2,4Ghz

NEW!



PASTILLA DIMMABLE TRIAC WiFi RF UART HOLE 200W



Ref

PVPR

CONTR-104

58,50€

tuya

230 V -



Accesorio control remoto pulsador dimmable  
CONTR-105 (No incluido)

CONTR-105

14,43€

NEW!



PASTILLA ON/OFF WiFi RF UART HOLE 250W



Ref

CONTR-117

tuya

230 V -



Mando control remoto ON/OFF  
CONTR-118 (No incluido)

CONTR-118

NO DISPONE DE WiFi



**PASTILLA PULSADOR CON EFECTO MEMORIA - FUNCIONA PARA VARIOS PULSADORES - NO DISPONE DE WiFi**

PASTILLA DIMMABLE TRIAC POR PULSADOR



MÁX 200W



CONTR-022

52,62€

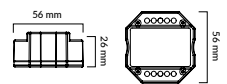

CONTR-036 CONTR-056

COMPATIBLE CON MANDO CONTR-036 Y CONTR-056

**REGULACIÓN TRIAC**



PASTILLA DIMMABLE TRIAC LED SIN NEUTRO MÁX 250W



SIN NEUTRO MÁX 250W



CONTR-083

55,02€

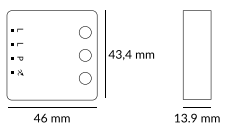

Este dimmer LED está diseñado para el control de lámparas LED regulables de hasta 250W. Con características de diseño compacto, brillo ajustable, potencia y memoria de ajuste de luz, es fácil de instalar y operar.

- Tamaño compacto
- Sin ruido
- Regulación del borde de salida
- No necesita línea neutra
- Ideal para reequipamiento
- Luminosidad y velocidad de regulación regulables
- Memoria de potencia y luminosidad

**REGULACIÓN TRIAC**



- REGULACIÓN TRIAC
- NO DISPONE DE WiFi
- NO APTA PARA INSTALACIONES CONMUTADAS
- SE PUEDE USAR CON PULSADORES EN PARALELO



*Serie Aros*

---

## Serie Aros GU10 - Aluminio

PARA  
**DICROICA GU10**



-Para Dicroicas GU10-MR16 - Aluminio - Lámpara no incluida - Incluye portalámparas



**360°**  
BASCULANTE  
EN UNA ÚNICA  
ORIENTACIÓN

### ARO AXIS REDONDO BASCULANTE



**ALUMINIO**



Negro ARO-019 8,13€



Aluminio brushed ARO-018 8,13€

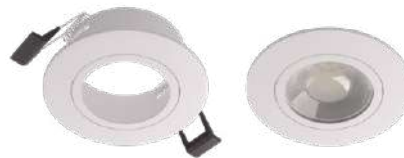

Blanco mate ARO-017 8,13€

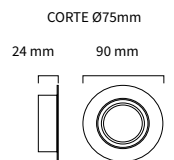

### ARO AXIS CUADRADO BASCULANTE



Negro ARO-022 8,49€



Aluminio brushed ARO-021 8,49€

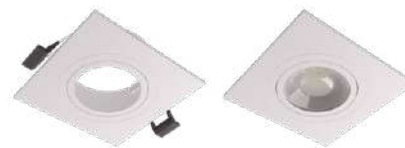

Blanco mate ARO-020 8,49€

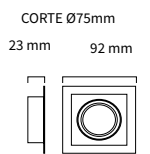

### ARO AXIS CUADRADO DOBLE BASCULANTE

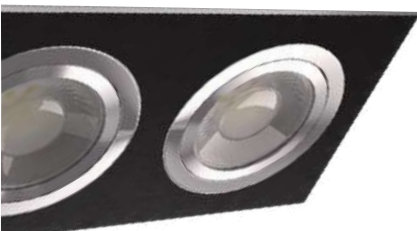

Negro ARO-025 16,02€



Aluminio brushed ARO-024 16,02€



Blanco mate ARO-023 16,02€

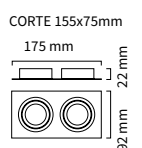



## AROS ASIMÉTRICOS ANTIDESLUMBRANTE

-Para Dicroicas GU10-MR16 - Lámpara no incluida - No Incluye portalámparas



ALUMINIO



### ARO AXIS D95 REDONDO 30° INCLINACIÓN



CORTE Ø89mm

60 mm 96 mm



Blanco y oro mate 12,42€  
ARO-044



Blanco y negro mate 12,42€  
ARO-045



Blanco 10,29€  
ARO-046

### ARO AXIS D95 CUADRADO 30° INCLINACIÓN



CORTE 89 x 89 mm

60 mm 96 mm

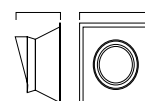

Blanco y oro mate 12,42€  
ARO-047



Blanco y negro mate 12,42€  
ARO-048



Blanco 10,29€  
ARO-049

## AROS ANTIDESLUMBRANTE

-Para Dicroicas GU10-MR16 - Lámpara no incluida - No Incluye portalámparas



ALUMINIO



### ARO AXIS CIRCULAR BASCULANTE



CORTE Ø85mm

41 mm 93 mm



Negro 9,96€  
ARO-042



Negro 9,06€  
ARO-043



Blanco 9,96€  
ARO-013



Blanco 9,06€  
ARO-014



Negro 9,06€  
ARO-043



Negro 9,96€  
ARO-042



Blanco 9,96€  
ARO-013



Blanco 9,06€  
ARO-014

CORTE Ø84mm

50 mm 90 mm

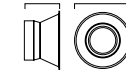

### ARO AXIS CUADRADO BASCULANTE



CORTE 81 x 81mm

41 mm 90 mm



Blanco 10,65€  
ARO-015

### ARO AXIS CIRCULAR BASCULANTE



35 mm 93 mm



CORTE Ø75mm



Blanco 9,06€  
ARO-016

Transporte no incluido. Para más información y descarga de fichas técnicas - [www.atmoss.es](http://www.atmoss.es) -

TODOS LOS PRECIOS SON EN PVPR Y ESTÁN SUJETOS A MODIFICACIONES. LOS PRECIOS ESTÁN CORRECTOS SALVO ERROR TIPOGRÁFICO, EN ÚLTIMA INSTANCIA COMPROBAR EN TARIFA DE PRECIOS - COMPROBAR MEDIDAS CON EL ARTICULO EN FÍSICO YA QUE PUEDE HABER ERROR TIPOGRÁFICO

## Serie Aros Zona húmeda - Aluminio

PARA  
**DICROICA GU10**



-Para Dicroicas GU10-MR16 - Lámpara no incluida - Incluye portalámparas

APLIQUE **ESTANCO**



**ALUMINIO**



Negro ARO-138 12,30€



Negro ARO-137 12,30€

IP  
54



-Para Dicroicas GU10-MR16 - Lámpara no incluida - No Incluye portalámparas

APLIQUE **ESTANCO**



**ALUMINIO**



Negro APQ-038  
10,50€



Blanco APQ-037  
10,50€

IP  
65

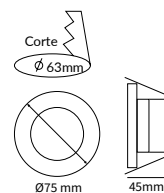

Negro APQ-042  
11,61€



Blanco APQ-041  
11,61€

IP  
65

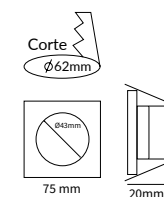

APLIQUE **INTERIOR**



**ALUMINIO**



Negro APQ-040  
9,93€



Blanco APQ-039  
9,93€

IP  
20

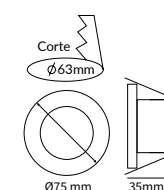

\* Según la nueva normativa ERP ha habido un cambio en la medición de Lúmenes y vatios, pero sigue emitiendo la misma cantidad de luz.

A medida que vayan entrando los nuevos modelos con ERP se irá actualizando en catálogo y cajas de color.

Puede haber variación respecto la caja del producto (comprobar en ficha técnica), todos los datos en catálogo están correctos salvo error tipográfico.

## Serie Aros GU10 - Material PC

PARA  
DICROICA GU10



-Para Dicroicas GU10-MR16 - Material PC  
Lámpara no incluida - Incluye portalámparas



**MATERIAL PC**



### CAMBIO DE DICROICA SIN DESMONTAR ARO



ARO-055 / 054  
051 / 050

### ARO PLS-128/I CUADRADO BASCULANTE EMPOTRABLE



Negro ARO-055 4,14€



Blanco ARO-054 4,14€

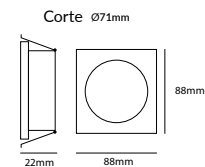

### ARO PLS-119 REDONDO BASCULANTE EMPOTRABLE



Negro ARO-051 4,86€



Blanco ARO-050 4,86€

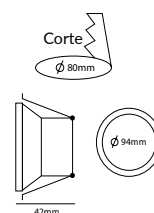

### ARO PLS-123 REDONDO BASCULANTE EMPOTRABLE



Negro ARO-053 4,14€



Blanco ARO-052 4,14€

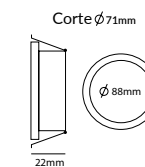

-Para Dicroicas GU10-MR16 - Material PC  
Lámpara no incluida - Incluye portalámparas



**MATERIAL PC**



**ARO PLS-90-25 CIRCULAR BASCULANTE EMPOTRABLE**



Negro  
ARO-070 4,74€



Blanco + Negro  
ARO-069 4,74€



Blanco  
ARO-068 4,74€

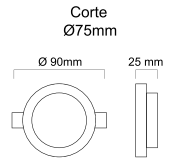

**ARO PLS-90-25 CUADRADO BASCULANTE EMPOTRABLE**



Negro  
ARO-073 5,01€



Blanco + Negro  
ARO-072 5,01€



Blanco  
ARO-071 5,01€

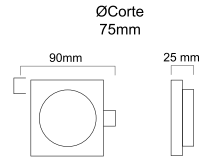

**ARO PLS-172-28/2 CUADRADO BASCULANTE EMPOTRABLE**



Negro  
ARO-076 10,14€



Blanco + Negro  
ARO-075 10,14€



Blanco  
ARO-074 10,14€

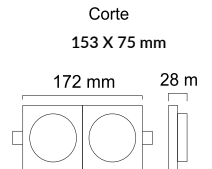

**ARO PLS-255-28/3 CUADRADO BASCULANTE EMPOTRABLE**



Negro  
ARO-079 16,38€



Blanco + Negro  
ARO-078 16,38€



Blanco  
ARO-077 16,38€

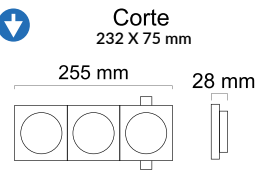

-Para Dicroicas GU10-MR16 - Material PC  
Lámpara no incluida - Incluye portalámparas



**MATERIAL PC**



**ARO-102 - ARO PC REDONDO BASCULANTE 93x50mm  
EMPOTRABLE BLANCO**

PVPR  
5,19€

**ARO-103 - ARO PC REDONDO BASCULANTE 93x50mm  
EMPOTRABLE NEGRO**

5,19€

Corte: Ø85mm

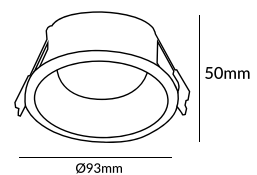

- COLOCACIÓN DE LÁMPARA POR LA PARTE TRASERA

\* Según la nueva normativa ERP ha habido un cambio en la medición de Lúmenes y vatios, pero sigue emitiendo la misma cantidad de luz. A medida que vayan entrando los nuevos modelos con ERP se irá actualizando en catálogo y cajas de color. Puede haber variación respecto la caja del producto (comprobar en ficha técnica), todos los datos en catálogo están correctos salvo error tipográfico.



-Para Dicroicas GU10-MR16 - Material PC  
Lámpara no incluida - Incluye portalámparas



**MATERIAL PC**



**ARO PLS-72-103 CIRCULAR SUPERFICIE**



Negro  
ARO-064 8,07€



Blanco + Negro  
ARO-063 8,07€



Blanco  
ARO-062 8,07€

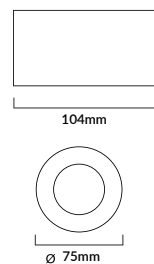

**ARO PLS-76-100 CUADRADO SUPERFICIE**



Negro  
ARO-067 9,30€



Blanco + Negro  
ARO-066 9,30€



Blanco  
ARO-065 9,30€

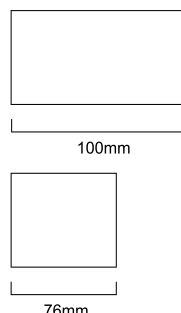

-Para Dicroicas GU10-MR16 - Material PC  
Lámpara no incluida - Incluye portalámparas



**MATERIAL PC**

**COLOR IDÉNTICO  
ALUMINIO BRUSHED**



Ref

**ARO-089 - ARO PLS-85-40 CIRCULAR GU10**  
BASCULANTE ALUMINIO BRUSHED

PVPR

4,86€



**ARO-091 - ARO PLS-85-40 CUADRADO GU10**  
BASCULANTE ALUMINIO BRUSHED

4,86€

CORTE: Ø72mm

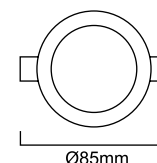
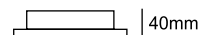

**ARO-088 - ARO PLS-85-40 CIRCULAR GU10**  
BASCULANTE PERLA MATE

3,30€

**ARO-090 - ARO PLS-85-40 CUADRADO GU10**  
BASCULANTE PERLA MATE

3,30€

CORTE: Ø72mm

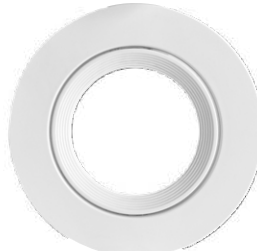
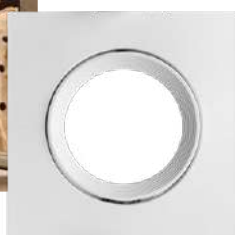
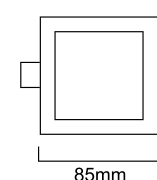
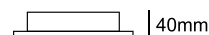



-Para Dicroicas GU10-MR16 - Material PC  
Lámpara no incluida - Incluye portalámparas



**MATERIAL PC**



ARO ABS GU10 BASCULANTE

**NEW!**



Blanco  
ARO-095 PVPR 5,01€



Blanco  
ARO-092 PVPR 4,74€

CORTE: Ø75mm

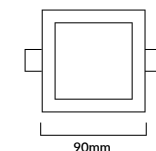
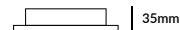

CORTE: Ø75mm

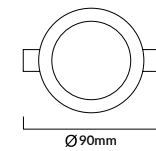
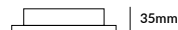

Negro  
ARO-096 PVPR 5,01€



Negro  
ARO-093 PVPR 4,74€

CORTE: Ø75mm

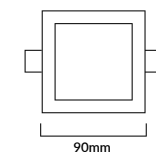
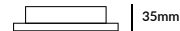

CORTE: Ø75mm

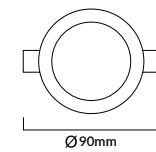
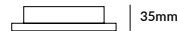

Silver  
ARO-097 PVPR 5,40€



Silver  
ARO-094 PVPR 5,10€

CORTE: Ø75mm

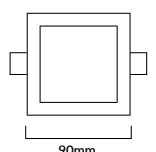

CORTE: Ø75mm

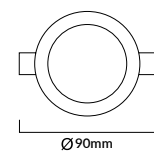
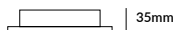

Blanco  
ARO-100 PVPR 3,30€



Blanco  
ARO-098 PVPR 3,15€

CORTE: 75x75mm

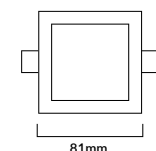
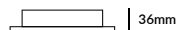

CORTE: Ø75mm

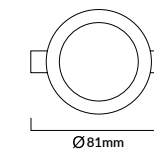
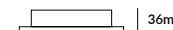

Negro  
ARO-101 PVPR 3,30€



Negro  
ARO-099 PVPR 3,15€

CORTE: 75x75mm

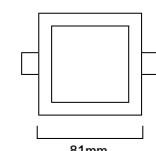
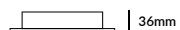

CORTE: Ø75mm

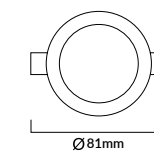
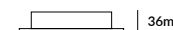

\* Según la nueva normativa ERP ha habido un cambio en la medición de Lúmenes y vatios, pero sigue emitiendo la misma cantidad de luz. A medida que vayan entrando los nuevos modelos con ERP se irá actualizando en catálogo y cajas de color. Puede haber variación respecto la caja del producto (comprobar en ficha técnica), todos los datos en catálogo están correctos salvo error tipográfico.



-Para Dicroicas GU10-MR16 - Material PC  
Lámpara no incluida - Incluye portalámparas



**MATERIAL PC**



**ARO PLS-93/45 REDONDO BASCULANTE EMPOTRABLE**



Negro ARO-087 4,62€



Blanco ARO-086 4,62€

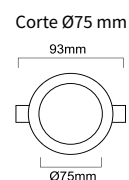

**ARO PLS-93/45 CUADRADO BASCULANTE EMPOTRABLE**



Negro ARO-081 4,74€



Blanco ARO-080 4,74€

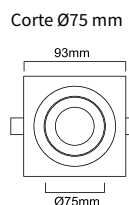

**ARO PLS-173-45/2 CUADRADO BASCULANTE EMPOTRABLE**



Negro  
ARO-083 10,62€



Blanco  
ARO-082 10,62€

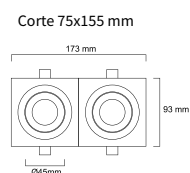

**ARO PLS-255-45/3 CUADRADO BASCULANTE EMPOTRABLE**



Negro  
ARO-085 16,56€



Blanco  
ARO-084 16,56€

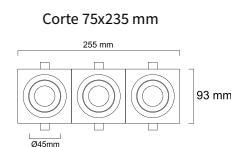

## Serie Aros Zona húmeda - Material PC

PARA  
**DICROICA GU10**



### Aplique interior estanco

IP  
65



-Para Dicroicas GU10-MR16 - Material PC  
Lámpara no incluida - Incluye portalámparas

100 IP  
65

**MATERIAL PC**

**PARA ZONAS HUMEDAS**

**NEW!**



Negro  
ARO-124



Blanco  
ARO-125

PVPR  
8,19€

CORTE: Ø73-75mm

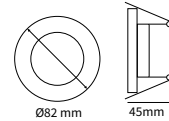

Negro  
ARO-126



Blanco  
ARO-127

PVPR  
7,02€

CORTE: Ø75mm

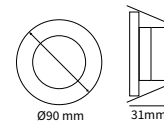

Negro  
ARO-128



Blanco  
ARO-129

PVPR  
7,65€

**ACABADO EFECTO BRUSHED**

CORTE: Ø75mm

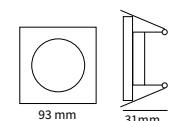

# Serie Aros Especial tiendas - Aluminio



PARA  
**BOMBILLA QR111**  
Y PAR27



-Para QR111 - GU10 - Aluminio  
Lámpara no incluida - Incluye portalámparas



**ALUMINIO**

**NEW!**



Negro  
ARO-122



Blanco  
ARO-123

**PVPR**  
25,56€



Negro  
ARO-120



Blanco  
ARO-121

**PVPR**  
26,91€



**ARO BIONIQ**  
CIRCULAR BASCULANTE SUPERFICIE



QR111



**ALUMINIO**

Lámpara no incluida - Incluye portalámparas



Blanco  
ARO-038

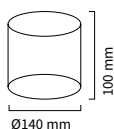

**PVPR**  
50,10€

-Para QR111 - GU10 - Aluminio  
Lámpara no incluida - Incluye portalámparas



**ALUMINIO**

**NEW!**



Negro  
ARO-116



Blanco  
ARO-117

**PVPR**  
25,56€



Negro  
ARO-118



Blanco  
ARO-119

**PVPR**  
26,76€

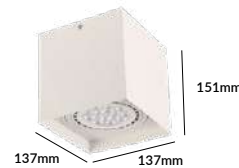

## Serie Aros Especial tiendas - Aluminio

PARA  
BOMBILLA QR111

QR111



### ARO BIONIQ REDONDO BASCULANTE

Lámpara no incluida - No Incluye portalámparas



ALUMINIO



Cromo mate ARO-008 72,06€



Blanco ARO-007 61,23€

CORTE Ø143mm

Ø190 mm

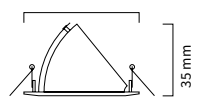

### ARO BIONIQ REDONDO ORIENTABLE 360°

Lámpara no incluida - No Incluye portalámparas



### ARO BIONIQ CUADRADO ORIENTABLE 360°

Lámpara no incluida - No Incluye portalámparas



Cromo mate ARO-010 21,51€

CORTE Ø147mm  
Ø170 mm



Cromo mate ARO-012 21,51€

CORTE 165x165mm

174 mm

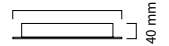

Hasta fin de existencias

### ARO BIONIQ CIRCULAR BASCULANTE EMPOTRAR

Lámpara no incluida - Incluye portalámparas



ALUMINIO



Negro ARO-041 25,62€



Blanco ARO-040 25,62€

Corte Ø131 mm

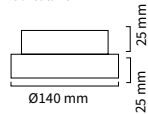

# Serie Aros Especial tiendas - Aluminio

PARA  
BOMBILLA QR111

QR111



-Aro basculante para QR111 - Lámpara no incluida



**ALUMINIO**

ARO BIONIQ CUADRADO BASCULANTE



Aluminio brushed  
ARO-027



Negro  
ARO-028



Blanco  
ARO-026

**PVPR**  
33,06€

**ARO-027**  
No incluye portalámparas

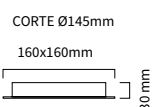

**ARO-026/028**  
Incluye portalámparas

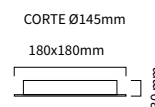

Lámpara no incluida - No Incluye portalámparas

ARO BIONIQ CIRCULAR BASCULANTE



Aluminio brushed  
ARO-036

**PVPR**  
17,70€



Negro  
ARO-037

**PVPR**  
19,89€



Blanco  
ARO-130

**PVPR**  
17,70€

CORTE Ø140mm

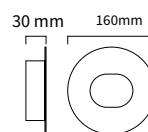

Lámpara no incluida - Incluye portalámparas

ARO BIONIQ CUADRADO BASCULANTE DOBLE



Aluminio brushed  
ARO-030



Negro  
ARO-031



Blanco  
ARO-029

**PVPR**  
66,24€

CORTE 330x150mm

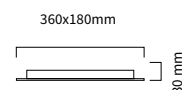

Lámpara no incluida - No Incluye portalámparas

ARO BIONIQ CUADRADO BASCULANTE TRIPLE



Aluminio brushed  
ARO-033



Negro  
ARO-034



Blanco mate  
ARO-032

**PVPR**  
97,86€

CORTE 450x145mm  
465x160mm

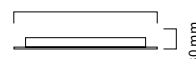

# Serie Aros Especial tiendas - Material PC

PARA  
**BOMBILLA QR111**  
Y PAR27

QR111

E27



**NEW!**



## Accesorio **unión** entre Aros

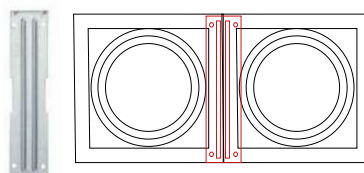

ACLED-464  
**UNIÓN ENTRE AROS**  
120 x 24.8 x 5.9MM

-Para QR111 - GU10 - Material PC  
Lámpara no incluida - Incluye portalámparas

GU10 QR111



### MATERIAL PC



Blanco  
ARO-106

Negro  
ARO-107

**PVPR**  
10,35€



Blanco  
ARO-110

Negro  
ARO-111

**PVPR**  
10,80€



-Para PAR30 E27 - Material PC  
Lámpara no incluida - Incluye portalámparas

E27



### MATERIAL PC



Blanco  
ARO-104

Negro  
ARO-105

**PVPR**  
10,35€



Blanco  
ARO-108

Negro  
ARO-109

**PVPR**  
10,80€

\* Según la nueva normativa ERP ha habido un cambio en la medición de Lúmenes y vatios, pero sigue emitiendo la misma cantidad de luz. A medida que vayan entrando los nuevos modelos con ERP se irá actualizando en catálogo y cajas de color. Puede haber variación respecto la caja del producto (comprobar en ficha técnica), todos los datos en catálogo están correctos salvo error tipográfico.

## Serie Aros Especial tiendas - Material PC

PARA  
BOMBILLA QR111  
Y PAR27

QR111

E27

-Para GU10 - Material PC  
Lámpara no incluida

GU10

QR111



**MATERIAL PC**

**NEW!**



Blanco  
ARO-114

**PVPR**  
9,90€

Corte  
Ø145mm

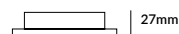

Negro  
ARO-115

**PVPR**  
9,90€

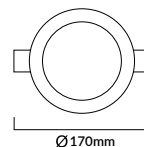

-Para PAR30 E27 - Material PC  
Lámpara no incluida  
BLED-118-119-120

E27



Blanco  
ARO-112

**PVPR**  
9,90€

Corte  
Ø145mm

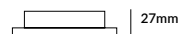

Negro  
ARO-113

**PVPR**  
9,90€

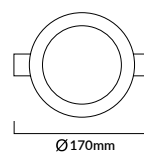

# Serie Aros Especial tiendas - Material PC

PARA  
BOMBILLA QR111



-Para QR111 - GU10 - Material PC  
Lámpara no incluida



**MATERIAL PC**

**NEW!**



ARO PC-160 REDONDO QR111

*Basculante blanco*

REF  
ARO-131 PVPR  
7,62€

MÁX 15w IP 20 100



ARO PC-160 REDONDO QR111

*Basculante negro*

ARO-132 7,62€

MÁX 15w IP 20 100



ARO PC-160 REDONDO QR111

*Basculante blanco y negro*

ARO-133 7,62€

MÁX 15w IP 20 100

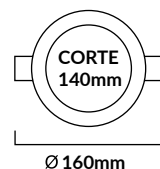

ARO PC-160X160 CUADRADO QR111

*Basculante blanco*

REF  
ARO-134 PVPR  
8,04€

MÁX 15w IP 20 100



ARO PC-160X160 CUADRADO QR111

*Basculante negro*

ARO-135 8,04€

MÁX 15w IP 20 100

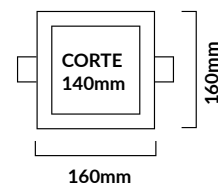

ARO PC-160X160 CUADRADO QR111

*Basculante blanco y negro*

ARO-136 8,04€

MÁX 15w IP 20 100

\* Según la nueva normativa ERP ha habido un cambio en la medición de Lúmenes y vatios, pero sigue emitiendo la misma cantidad de luz. A medida que vayan entrando los nuevos modelos con ERP se irá actualizando en catálogo y cajas de color. Puede haber variación respecto la caja del producto (comprobar en ficha técnica), todos los datos en catálogo están correctos salvo error tipográfico.





*Serie* **Apliques**

---



## Serie APLIQUES INTERIOR ALUMINIO

IP 20



### LED INCLUIDO

### SERIE ALUMINIO

					Ref	PVPR
TRACK-LIGHT PARED	2W	CON USB	ALUMINIO	BLANCO	TRCK-103	46,74€
TRACK-LIGHT PARED	2W	CON USB	ALUMINIO	NEGRO	TRCK-104	46,74€



Tipo A y C



Tipo A - 2000mAh  
Tipo C - 3000mAh



BOTÓN ON/OFF

### LED NO INCLUIDO

### SERIE ALUMINIO

Para Dicroica Gu10, No incluida - Incluye portalámparas - LUZ EN 1 DIRECCIÓN

			Ref	PVPR
APLIQUE INTERIOR DE SUPERFICIE AT-426	Blanco - Lámpara GU10	APQ-035	20,22€	
APLIQUE INTERIOR DE SUPERFICIE AT-426	Negro - Lámpara GU10	APQ-036	20,22€	



Aplique para 1 lámpara

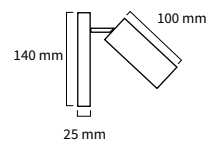



NEW!



LED NO INCLUIDO

SERIE ALUMINIO

					Ref	PVPR
LÁMPARA COLGANTE	SUPERFICIE	GU10	ALUMINIO	BLANCO	TRCK-101	34,32€
LÁMPARA COLGANTE	SUPERFICIE	GU10	ALUMINIO	NEGRO	TRCK-102	34,32€



NEW!



LED INCLUIDO

SERIE ALUMINIO

LUZ EN 2 DIRECCIONES

					Ref	PVPR
APLIQUE LED INTERIOR CUADRADO	Negro	6W	3200K	●	APQ-501	16,80€
APLIQUE LED INTERIOR CUADRADO	Negro	6W	5000K	●	APQ-502	16,80€
APLIQUE LED INTERIOR CUADRADO	Blanco	6W	3200K	●	APQ-503	16,80€
APLIQUE LED INTERIOR CUADRADO	Blanco	6W	5000K	●	APQ-504	16,80€

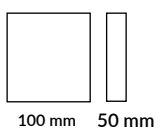

\* Según la nueva normativa ERP ha habido un cambio en la medición de Lúmenes y vatios, pero sigue emitiendo la misma cantidad de luz. A medida que vayan entrando los nuevos modelos con ERP se irá actualizando en catálogo y cajas de color. Puede haber variación respecto la caja del producto (comprobar en ficha técnica), todos los datos en catálogo están correctos salvo error tipográfico.

# Serie APLIQUES INTERIOR ALUMINIO



PARA  
**BOMBILLA G9**



## SERIE ALUMINIO



Para Lámpara G9 No incluida - Incluye portalámparas - LUZ EN DOS DIRECCIONES

APLIQUE INTERIOR DE SUPERFICIE AT-40I

Blanco - Lámpara G9

Ref

PVPR

APQ-029

26,40€

APLIQUE INTERIOR DE SUPERFICIE AT-40I

Negro - Lámpara G9

APQ-030

26,40€



Aplique para 1 lámpara

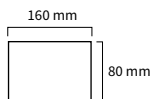

Para Lámpara G9 No incluida - Incluye portalámparas - LUZ EN DOS DIRECCIONES

APLIQUE INTERIOR DE SUPERFICIE AT-402

Blanco - Lámpara G9

APQ-031

20,67€

APLIQUE INTERIOR DE SUPERFICIE AT-402

Negro - Lámpara G9

APQ-032

20,67€



Aplique para 1 lámpara

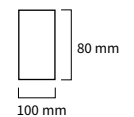

Para Lámpara G9 No incluida - Incluye portalámparas - LUZ EN DOS DIRECCIONES

APLIQUE INTERIOR DE SUPERFICIE AT-403

Blanco - Lámpara G9

APQ-033

26,40€

APLIQUE INTERIOR DE SUPERFICIE AT-403

Negro - Lámpara G9

APQ-034

26,40€



Aplique para 1 lámpara

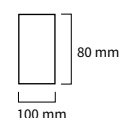

# APLIQUES INTERIOR

IP 20

PARA BOMBILLA G9



## SERIE ALUMINIO



Con reposición de G9 (No incluida) - Incluye portalámparas

		Ref	PVPR
APLIQUE INTERIOR REDONDO ALUMINIO	Para lámpara G9 Blanco	APQ-462	18,24€
APLIQUE INTERIOR REDONDO ALUMINIO	Para lámpara G9 Negro	APQ-463	18,24€

MÁX30W



230 VDC

IP 20



Aplique para 1 lámpara

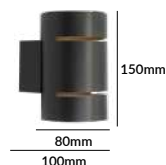

Con reposición de G9 (No incluida) - Incluye portalámparas

APLIQUE INTERIOR RECTANGULAR ALUMINIO	Para lámpara G9 Blanco	APQ-464	20,34€
APLIQUE INTERIOR RECTANGULAR ALUMINIO	Para lámpara G9 Negro	APQ-465	20,34€

MÁX30W



230 VDC

IP 20



Aplique para 1 lámpara

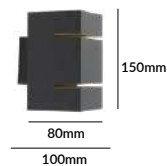

Con reposición de G9 (No incluida) - Incluye portalámparas

APLIQUE INTERIOR CUADRADO ALUMINIO	Para lámpara G9 Blanco	APQ-466	19,86€
APLIQUE INTERIOR CUADRADO ALUMINIO	Para lámpara G9 Negro	APQ-467	19,86€

MÁX30W



230 VDC

IP 20



Aplique para 1 lámpara

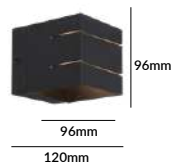



# Luz nocturna con sensor de movimiento

Aplicques Interior **IP 20**

Multiples aplicaciones, pasillos, escaleras, zonas de paso,...



AUTO 1

OFF

AUTO 2

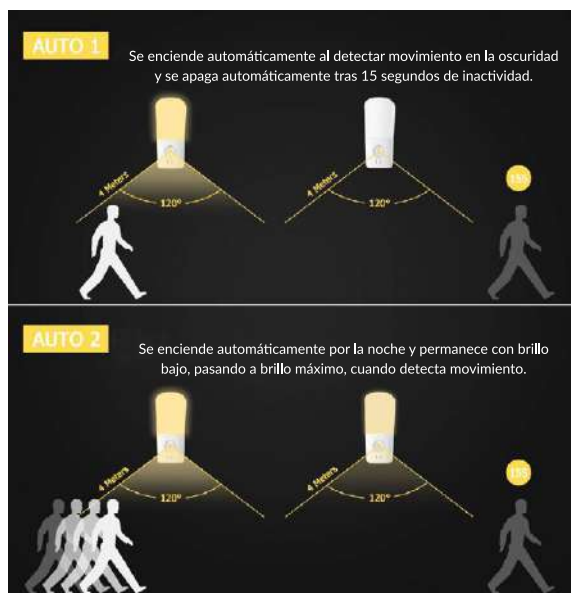

Pack de 2 uds

K° Ref PVPR

LUZ NOCTURNA CON SENSOR MOVIMIENTO 1W 80Lm 3200K ACLED-456 28,08€

1w

80 Lm

230 V

2

120°

SENSOR PIR DE MOVIMIENTO

SENSOR CREPUSCULAR



Sensor de movimiento PIR



Sensor crepuscular



3 modos de trabajo



# Baliza de señalización con sensor de movimiento

Apliques  
Interior

IP  
20



DISEÑO  
MINIMALISTA

Este producto es compatible con las cajas universales cuadradas de 65 x 65 mm  
No compatible con cajas redondas o de pladur

	K°	Ref	PVPR
BALIZA DE SEÑALIZACIÓN LED <i>EMPOTRABLE SENSOR PIR 0,8w Blanco</i>	4000K	ACLED-452	17,40 €
BALIZA DE SEÑALIZACIÓN LED <i>EMPOTRABLE SENSOR PIR 0,8w Negro</i>	4000K	ACLED-453	17,40 €
BALIZA DE SEÑALIZACIÓN LED <i>EMPOTRABLE SENSOR PIR 0,8w Blanco</i>	3000K	ACLED-454	17,40 €
BALIZA DE SEÑALIZACIÓN LED <i>EMPOTRABLE SENSOR PIR 0,8w Negro</i>	3000K	ACLED-455	17,40 €

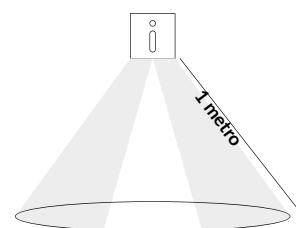

Tiempo de retardo 40 seg



5,2cm



8,2cm

## Serie APLIQUES EXTERIOR ALUMINIO

IP  
65

PARA  
**BOMBILLA E27**



**NEW!**



**SERIE ALUMINIO**

**PANEL-CRISTAL**

APLIQUE DE PARED CON PANEL DE CRISTAL *Negro* *MÁX 28W*

Ref PVPR

APQ-484 40,92€

Lámpara para Bombilla E27  
(Bombilla no incluida)



230  
V

IP  
65

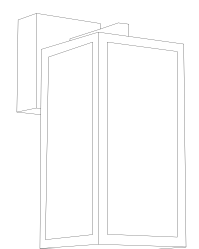

215mm

115mm

## APLIQUES EXTERIOR

IP 65

PARA  
DICROICA GU10



### SERIE ALUMINIO

#### LUZ EN 1 DIRECCION



Para Lámpara Gu10 No incluida - Incluye portalámparas

	Ref	PVPR
APLIQUE EXTERIOR ALUMINIO CIRCULAR SUPERFICIE Negro - Lámpara GU10	APQ-080	20,85€
APLIQUE EXTERIOR ALUMINIO CIRCULAR SUPERFICIE Blanco - Lámpara GU10	APQ-081	20,85€
APLIQUE EXTERIOR ALUMINIO CIRCULAR SUPERFICIE Gris - Lámpara GU10	ARO-058	18,51€



Aplique para 1 lámpara

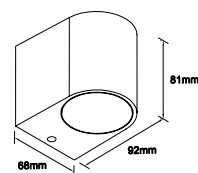

Para Lámpara Gu10 No incluida - Incluye portalámparas

	Ref	PVPR
APLIQUE EXTERIOR ALUMINIO CUADRADO SUPERFICIE Negro - Lámpara GU10	APQ-084	20,85€
APLIQUE EXTERIOR ALUMINIO CUADRADO SUPERFICIE Blanco - Lámpara GU10	APQ-085	20,85€



Aplique para 1 lámpara

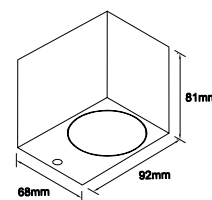

#### LUZ EN 2 DIRECCIONES



Para Lámpara Gu10 No incluida - Incluye portalámparas

	Ref	PVPR
APLIQUE EXTERIOR ALUMINIO CIRCULAR SUPERFICIE Negro - Lámpara GU10	APQ-082	29,07€
APLIQUE EXTERIOR ALUMINIO CIRCULAR SUPERFICIE Blanco - Lámpara GU10	APQ-083	29,07€
APLIQUE EXTERIOR ALUMINIO CIRCULAR SUPERFICIE Gris - Lámpara GU10	ARO-061	27,18€



Aplique para 2 lámparas

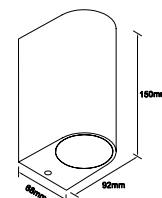

Para Lámpara Gu10 No incluida - Incluye portalámparas

	Ref	PVPR
APLIQUE EXTERIOR ALUMINIO CUADRADO SUPERFICIE Negro - Lámpara GU10	APQ-086	29,40€
APLIQUE EXTERIOR ALUMINIO CUADRADO SUPERFICIE Blanco - Lámpara GU10	APQ-087	29,40€



Aplique para 2 lámparas

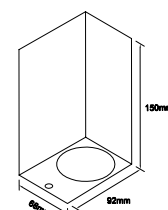

APLIQUES  
EXTERIOR



LED INCLUIDO

3 en 1 TRES TIPOS DE LUZ  
EN LA MISMA LUMINARIA

CÁLIDA

NEUTRA

FRÍA



Switch  
3CCT



SERIE PLASTIC

NEW!



\* Led incluido

ALTA  
LUMINOSIDAD

ESPECIAL  
FACHADA

K°

Ref

PVPR

	ALTA LUMINOSIDAD	ESPECIAL FACHADA	K°	Ref	PVPR
APLIQUE EXTERIOR CIRCULAR	18W 60°	3CCT		APQ-377	22,68 €
APLIQUE EXTERIOR RECTANGULAR	18W 60°	3CCT		APQ-378	23,16 €



165 mm

Φ 81 mm

102 mm



165 mm

81 mm

102 mm

NEW!



## APLIQUES EXTERIOR

IP 65

PARA  
DICROICA GU10



\* Led NO INCLUIDO - Incluye portalámparas

### SERIE ALUMINIO

			Ref	PVPR
APLIQUE EXTERIOR CIRCULAR ANILLO	Negro	MÁX 7W	APQ-480	35,52€
APLIQUE EXTERIOR CIRCULAR ANILLO	Blanco	MÁX 7W	APQ-481	35,52€

Aplique para Bombilla GU10  
(Bombilla no incluida)



Aplique para 2 lámparas

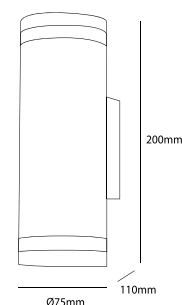

NEW!



\* Led NO INCLUIDO - Incluye portalámparas

### SERIE ALUMINIO

			Ref	PVPR
APLIQUE EXTERIOR RECTANGULAR ANILLO	Negro	MÁX 7W	APQ-309	38,85€
APLIQUE EXTERIOR RECTANGULAR ANILLO	Blanco	MÁX 7W	APQ-310	38,85€

Aplique para Bombilla GU10  
(Bombilla no incluida)



Aplique para 2 lámparas

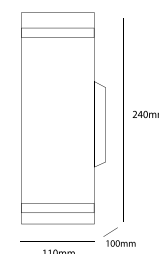

\* Led NO INCLUIDO - Incluye portalámparas

### SERIE PLASTIC

			Ref	PVPR
APLIQUE EXTERIOR RECTANGULAR ANILLO	Negro	MÁX 7W	APQ-482	27,90€
APLIQUE EXTERIOR RECTANGULAR ANILLO	Blanco	MÁX 7W	APQ-483	27,90€

Aplique para Bombilla GU10  
(Bombilla no incluida)



Aplique para 2 lámparas

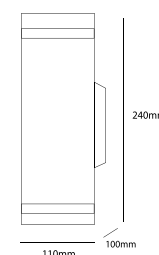

\* Según la nueva normativa ERP ha habido un cambio en la medición de Lúmenes y vatios, pero sigue emitiendo la misma cantidad de luz.

A medida que vayan entrando los nuevos modelos con ERP se irá actualizando en catálogo y cajas de color.

Puede haber variación respecto a la caja del producto (comprobar en ficha técnica), todos los datos en catálogo están correctos salvo error tipográfico.

APLIQUES  
EXTERIOR



PARA  
DICROICA GU10



**SERIE ALUMINIO**



NEW!

Para Lámpara **Gu10** No incluida - Incluye portalámparas

Ref

PVPR

APLIQUE EXTERIOR ALUMINIO CUADRADO SUPERFICIE **Negro - Lámpara GU10**

APQ-300

30,78€



Aplique para 1 lámparas



110 mm



NEW!

Para Lámpara **Gu10** No incluida - Incluye portalámparas

Ref

PVPR

APLIQUE EXTERIOR ALUMINIO CUADRADO SUPERFICIE **Negro - Lámpara GU10**

APQ-301

56,70€



Aplique para 2 lámparas



210 mm



**APLIQUES  
EXTERIOR**



**LED INCLUIDO**

**3 en 1 TRES TIPOS DE LUZ  
EN LA MISMA LUMINARIA**



**SERIE PLASTIC**

**NEW!**



	ALTA LUMINOSIDAD	ESPECIAL FACHADA	K°	Ref	PVPR
APLIQUE EXTERIOR CIRCULAR ANILLO TRANSPARENTE	18W	60°	3CCT	APQ-379	26,46 €
APLIQUE EXTERIOR CUADRADO ANILLO TRANSPARENTE	18W	60°	3CCT	APQ-380	27,96 €

\* Led incluido

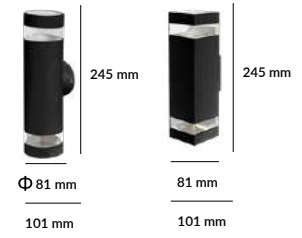

\* Según la nueva normativa ERP ha habido un cambio en la medición de Lúmenes y vatios, pero sigue emitiendo la misma cantidad de luz. A medida que vayan entrando los nuevos modelos con ERP se irá actualizando en catálogo y cajas de color. Puede haber variación respecto la caja del producto (comprobar en ficha técnica), todos los datos en catálogo estan correctos salvo error tipográfico.



**APLIQUES  
EXTERIOR**



**LED INCLUIDO**



**SERIE ALUMINIO**

**NEW!**



\* Led incluido

APLIQUE PARED    IP65    10W    NEGRO    3200K    ●    APQ-068    56,10€

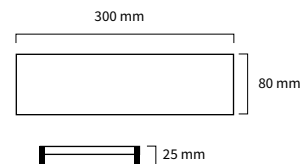

\* Led incluido

APLIQUE PARED    IP65    20W    NEGRO    3200K    ●    APQ-069    89,73€

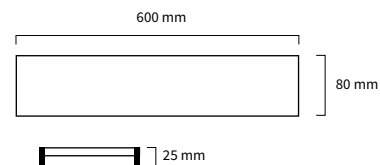

\* Led incluido

APLIQUE PARED    IP65    30W    NEGRO    3200K    ●    APQ-070    129,66€

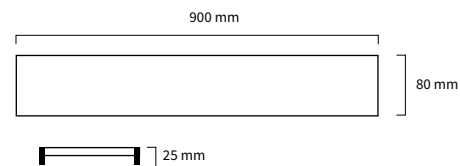



APLIQUES  
EXTERIOR



LED INCLUIDO

SERIE PLASTIC



\* Led incluido

LUZ EN 2 DIRECCIONES

			K°	Ref	PVPR
APLIQUE EXTERIOR RECTANGULAR UP&DOWN	12W	60°	3200K	APQ-375	10,56 €
APLIQUE EXTERIOR RECTANGULAR UP&DOWN	12W	60°	5000K	APQ-376	10,56 €



Aplique para 2 lámparas



144 mm

80 mm

# APLIQUES EXTERIOR



PARA BOMBILLA G9



## SERIE APLIQUE LUZ AJUSTABLE



### DISEÑO CON HAZ DE LUZ AJUSTABLE

El aplique de pared puede ajustar la luz de diferentes ángulos, y también puede iluminar un lado.

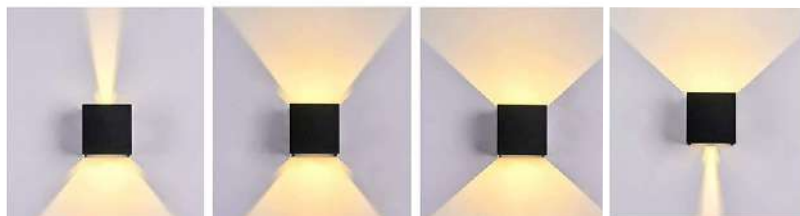

NEW!



Aplique para Bombilla G9 (Bombilla no incluida)

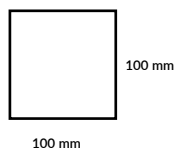

\* Led NO INCLUIDO - Incluye portalámparas

#### SERIE ALUMINIO

			Ref	PVPR
APLIQUE EXTERIOR CUADRADO ALUMINIO	Negro	MÁX 4W	APQ-478	26,82€
APLIQUE EXTERIOR CUADRADO ALUMINIO	Blanco	MÁX 4W	APQ-479	26,82€

NEW!



Aplique para Bombilla G9 (Bombilla no incluida)

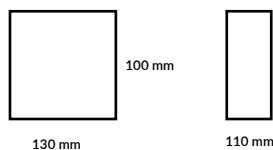

\* Led NO INCLUIDO - Incluye portalámparas

#### SERIE ALUMINIO

			Ref	PVPR
APLIQUE EXTERIOR OVAL ALUMINIO	Negro	MÁX 6W	APQ-476	27,60€
APLIQUE EXTERIOR OVAL ALUMINIO	Blanco	MÁX 6W	APQ-477	27,60€





**LED INCLUIDO**



\* Led incluido - Ángulo ajustable

**SERIE ALUMINIO**

		K°	Ref	PVPR	
	APLIQUE EXTERIOR CUADRADO ALUMINIO	Negro 10W Ajustable°	3000K	APQ-419	25,14 €
<b>NEW!</b>	APLIQUE EXTERIOR CUADRADO ALUMINIO	Negro 10W Ajustable°	4200K	APQ-439	25,14 €
	APLIQUE EXTERIOR CUADRADO ALUMINIO	Negro 10W Ajustable°	5000K	APQ-420	25,14 €
	APLIQUE EXTERIOR CUADRADO ALUMINIO	Blanco 10W Ajustable°	3000K	APQ-421	25,14 €
<b>NEW!</b>	APLIQUE EXTERIOR CUADRADO ALUMINIO	Blanco 10W Ajustable°	4200K	APQ-440	25,14 €
	APLIQUE EXTERIOR CUADRADO ALUMINIO	Blanco 10W Ajustable°	5000K	APQ-422	25,14 €

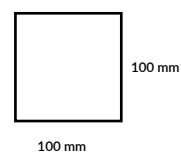

\* Led incluido - Ángulo ajustable

**SERIE PLASTIC**

		K°	Ref	PVPR	
	APLIQUE EXTERIOR CUADRADO PLS	Negro 10W Ajustable°	6000K	APQ-469	16,47 €

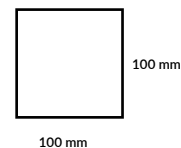

**3 en 1 TRES TIPOS DE LUZ EN LA MISMA LUMINARIA**



\* Led incluido - Ángulo ajustable

**SERIE ALUMINIO**

			K°	Ref	PVPR
	APLIQUE EXTERIOR CUADRADO ALUMINIO	Negro 6W	3CCCT	APQ-474	36,36 €
	APLIQUE EXTERIOR CUADRADO ALUMINIO	Blanco 6W	3CCCT	APQ-475	36,36 €

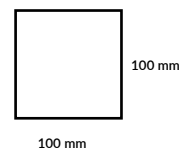

\* Led incluido - Ángulo ajustable

**SERIE ALUMINIO**

			K°	Ref	PVPR
	APLIQUE EXTERIOR OVAL ALUMINIO	Negro 6W	3CCCT	APQ-472	39,54 €
	APLIQUE EXTERIOR OVAL ALUMINIO	Blanco 6W	3CCCT	APQ-473	39,54 €

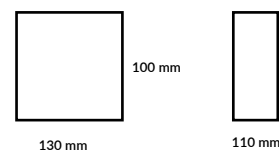

APLIQUES  
EXTERIOR



LED INCLUIDO

SERIE ALUMINIO



\* Led incluido - Ángulo ajustable

APLIQUE EXTERIOR CUADRADO ALUMINIO *Corten 10W Ajustable°*  
3000K ● APQ-442 27,72 €

APLIQUE EXTERIOR CUADRADO ALUMINIO *Corten 10W Ajustable°*  
4200K ● APQ-443 27,72 €

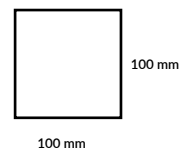

APLIQUES  
EXTERIOR



LED INCLUIDO



LED INCLUIDO

SERIE ALUMINIO

APLIQUE LED EXTERIOR CUADRADO *Negro 10W 3200K ● APQ-488 31,62€*



- Distancia detección 3 mts
- Tiempo encendido 30-40 seg

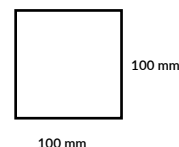



**APLIQUES  
EXTERIOR**



**LED INCLUIDO**

**3 en 1 TRES TIPOS DE LUZ  
EN LA MISMA LUMINARIA**



Switch  
**3CCT**



\* Led incluido

**SERIE ALUMINIO**

		K°	Ref	PVPR
APLIQUE EXTERIOR ALUMINIO 3CCT	6W	3CCT	APQ-470	37,86 €

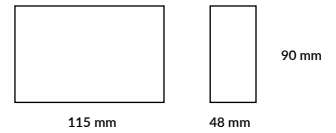

\* Led incluido

**SERIE ALUMINIO**

		K°	Ref	PVPR
APLIQUE EXTERIOR ALUMINIO 3CCT	12W	3CCT	APQ-471	40,20 €

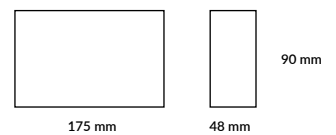

\* Según la nueva normativa ERP ha habido un cambio en la medición de Lúmenes y vatios, pero sigue emitiendo la misma cantidad de luz. A medida que vayan entrando los nuevos modelos con ERP se irá actualizando en catálogo y cajas de color. Puede haber variación respecto la caja del producto (comprobar en ficha técnica), todos los datos en catálogo están correctos salvo error tipográfico.

# APLIQUES EXTERIOR



LED INCLUIDO



## SERIE ALUMINIO



* Led incluido	K°	Ref	PVPR
APLIQUE EXTERIOR 2LED 2W - Negro - 3200K <span style="color: yellow;">●</span>		APQ-423	11,52 €
APLIQUE EXTERIOR 2LED 2W - Negro - 5000K <span style="color: blue;">●</span>		APQ-424	11,52 €



* Led incluido	K°	Ref	PVPR
APLIQUE EXTERIOR 4LED 4W - Negro - 3200K <span style="color: yellow;">●</span>		APQ-427	14,64 €
APLIQUE EXTERIOR 4LED 4W - Negro - 5000K <span style="color: blue;">●</span>		APQ-428	14,64 €



* Led incluido	K°	Ref	PVPR
APLIQUE EXTERIOR 6LED 6W - Negro - 3200K <span style="color: yellow;">●</span>		APQ-431	17,88 €
APLIQUE EXTERIOR 6LED 6W - Negro - 5000K <span style="color: blue;">●</span>		APQ-432	17,88 €



* Led incluido	K°	Ref	PVPR
APLIQUE EXTERIOR 8LED 8W - Negro - 3200K <span style="color: yellow;">●</span>		APQ-435	22,50 €
APLIQUE EXTERIOR 8LED 8W - Negro - 5000K <span style="color: blue;">●</span>		APQ-436	22,50 €

**SERIE ALUMINIO**



\* **Led incluido**      **Kº**      **Ref**      **PVPR**

**APLIQUE EXTERIOR 2LED**  
2W - Blanco - 3200K ● APQ-425 11,52 €

**APLIQUE EXTERIOR 2LED**  
2W - Blanco - 5000K ● APQ-426 11,52 €

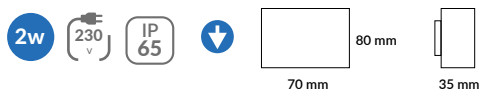

\* **Led incluido**

**APLIQUE EXTERIOR 4LED**  
4W - Blanco - 3200K ● APQ-429 14,64 €

**APLIQUE EXTERIOR 4LED**  
4W - Blanco - 5000K ● APQ-430 14,64 €

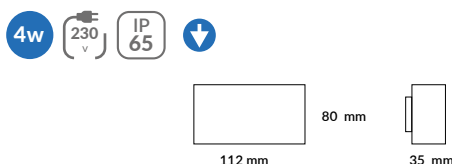

\* **Led incluido**

**APLIQUE EXTERIOR 6LED**  
6W - Blanco - 3200K ● APQ-433 17,88 €

**APLIQUE EXTERIOR 6LED**  
6W - Blanco - 5000K ● APQ-434 17,88 €

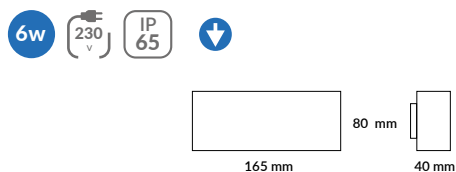

\* **Led incluido**

**APLIQUE EXTERIOR 8LED**  
8W - Blanco - 3200K ● APQ-437 22,50 €

**APLIQUE EXTERIOR 8LED**  
8W - Blanco - 5000K ● APQ-438 22,50 €

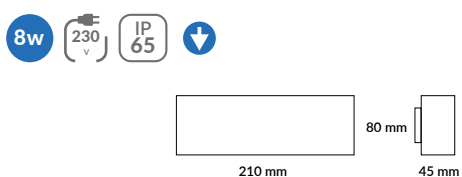

# APLIQUES EXTERIOR



LED INCLUIDO

3 en 1 TRES TIPOS DE LUZ EN LA MISMA LUMINARIA

CÁLIDA NEUTRA FRÍA



Switch 3CCT

SERIE PLASTIC



\* Led incluido

APLIQUE EXTERIOR AT-I4-2 Negro 2W

K° Ref PVPR

3CCT APQ-365 11,34 €



\* Led incluido

APLIQUE EXTERIOR AT-I4-2 Negro 4W

K° Ref PVPR

3CCT APQ-366 13,62 €



\* Led incluido

APLIQUE EXTERIOR AT-I4-2 Negro 6W

K° Ref PVPR

3CCT APQ-367 16,62 €



\* Led incluido

APLIQUE EXTERIOR AT-I4-2 Negro 8W

K° Ref PVPR

3CCT APQ-368 21,18 €





## APLIQUES EXTERIOR TECHO

IP  
65

PARA  
**DICROICA GU10**



### SERIE ALUMINIO

NEW!



\* Led no incluido

				Ref	PVPR
APLIQUE TECHO EXTERIOR	CIRCULAR	IP65	NEGRO	APQ-303	21,63€
APLIQUE TECHO EXTERIOR	CIRCULAR	IP65	BLANCO	APQ-304	21,63€

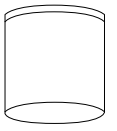

Ø90mm

NEW!



\* Led no incluido

				Ref	PVPR
APLIQUE TECHO EXTERIOR	CIRCULAR	IP65	NEGRO	APQ-305	29,40€
APLIQUE TECHO EXTERIOR	CIRCULAR	IP65	BLANCO	APQ-306	29,40€

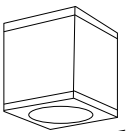

86mm

## Serie APLIQUES LUZ UNIFORME

IP 65

PARA  
**BOMBILLA VINTAGE**



Para una **LUZ UNIFORME**  
utilizar **BOMBILLAS VINTAGE**



**Bombilla Vintage**



**LUZ UNIFORME**

Compatible con las bombillas Vintage

BLED-390-391-392 - 6W  
BLED-405-406-407 - 10W  
BLED-170-171-172-174-176 - 4W  
BLED-177-178-179-237-238 - 8W

**NEW!**



LED NO INCLUIDO

SERIE ALUMINIO  
DIFUSOR VIDRIO

			Ref	PVPR
APLIQUE LED EXTERIOR	Blanco	E27	APQ-507	8,85€
APLIQUE LED EXTERIOR	Negro	E27	APQ-508	8,85€

MÁX 60w

230 V

IP 65



**Bombilla Vintage**



**LUZ UNIFORME**

**NEW!**



LED NO INCLUIDO

SERIE ALUMINIO  
DIFUSOR VIDRIO

			Ref	PVPR
APLIQUE LED EXTERIOR	Blanco	E27	APQ-509	8,85€
APLIQUE LED EXTERIOR	Negro	E27	APQ-510	8,85€

MÁX 60w

230 V

IP 65



**Bombilla Vintage**



**LUZ UNIFORME**



## APLIQUES EXTERIOR



PARA  
BOMBILLA VINTAGE



NEW!



LED NO INCLUIDO

SERIE ALUMINIO  
DIFUSOR VIDRIO

			Ref	PVPR
APLIQUE LED EXTERIOR	Blanco	E27	APQ-511	17,94€
APLIQUE LED EXTERIOR	Negro	E27	APQ-512	17,94€



Bombilla  
Vintage



LUZ  
UNIFORME

NEW!



LED NO INCLUIDO

SERIE ALUMINIO  
DIFUSOR VIDRIO

			Ref	PVPR
APLIQUE LED EXTERIOR	Blanco	E27	APQ-513	17,94€
APLIQUE LED EXTERIOR	Negro	E27	APQ-514	17,94€



Bombilla  
Vintage



LUZ  
UNIFORME

NEW!



LED NO INCLUIDO

SERIE ALUMINIO  
DIFUSOR VIDRIO

			Ref	PVPR
APLIQUE LED EXTERIOR	Blanco	E27	APQ-515	17,94€
APLIQUE LED EXTERIOR	Negro	E27	APQ-516	17,94€



Bombilla  
Vintage



LUZ  
UNIFORME

# APLIQUES EXTERIOR



PARA BOMBILLA VINTAGE



NEW!



LED NO INCLUIDO

SERIE ALUMINIO DIFUSOR VIDRIO

			Ref	PVPR
APLIQUE LED EXTERIOR	Blanco	E27	APQ-517	17,85€
APLIQUE LED EXTERIOR	Negro	E27	APQ-518	17,85€



NEW!



LED NO INCLUIDO

SERIE ALUMINIO DIFUSOR VIDRIO

			Ref	PVPR
APLIQUE LED EXTERIOR	Blanco	E27	APQ-519	17,85€
APLIQUE LED EXTERIOR	Negro	E27	APQ-520	17,85€



NEW!



LED NO INCLUIDO

SERIE ALUMINIO DIFUSOR VIDRIO

			Ref	PVPR
APLIQUE LED EXTERIOR	Blanco	E27	APQ-521	22,50€
APLIQUE LED EXTERIOR	Negro	E27	APQ-522	22,50€





**APLIQUES  
EXTERIOR**



**LED INCLUIDO**

**3 en 1 TRES TIPOS DE LUZ  
EN LA MISMA LUMINARIA**



Switch  
**3CCT**



**SERIE PLASTIC**

**2**  
DISEÑOS  
2 años  
intercambiables



**NEW!**



\* Led incluido

**ALTA  
LUMINOSIDAD**

**ESPECIAL  
FACHADA**

APLIQUE LED EXTERIOR RECTANGULAR *Blanco 20W 100°*

K°

Ref

PVPR

3CCT

APQ-523

17,10 €

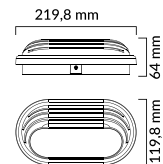

**2**  
DISEÑOS  
2 años  
intercambiables



**NEW!**



\* Led incluido

**ALTA  
LUMINOSIDAD**

**ESPECIAL  
FACHADA**

APLIQUE LED EXTERIOR CIRCULAR *Blanco 15W 100°*

K°

Ref

PVPR

3CCT

APQ-524

24,30 €

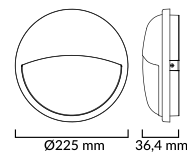

# APLIQUES EXTERIOR



LED INCLUIDO

## SERIE PLASTIC

\* Led incluido



		K°	Ref	PVPR
APLIQUE LED EXTERIOR OVAL	12W 120°	3200K	APQ-007	11,04€
APLIQUE LED EXTERIOR OVAL	12W 120°	4200K	APQ-008	11,04€
APLIQUE LED EXTERIOR OVAL	12W 120°	5000K	APQ-009	11,04€
APLIQUE LED EXTERIOR CIRCULAR	12W 120°	3200K	APQ-010	11,04€
APLIQUE LED EXTERIOR CIRCULAR	12W 120°	4200K	APQ-011	11,04€
APLIQUE LED EXTERIOR CIRCULAR	12W 120°	5000K	APQ-012	11,04€

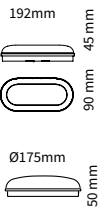

\* Led incluido



APLIQUE LED EXTERIOR OVAL	Blanco 15W 100°	3200K	APQ-017	18,45€
APLIQUE LED EXTERIOR OVAL	Blanco 15W 100°	4200K	APQ-018	18,45€
APLIQUE LED EXTERIOR OVAL	Blanco 15W 100°	5000K	APQ-019	18,45€
APLIQUE LED EXTERIOR OVAL	Gris 15W 100°	3200K	APQ-020	18,45€
APLIQUE LED EXTERIOR OVAL	Gris 15W 100°	4200K	APQ-021	18,45€
APLIQUE LED EXTERIOR OVAL	Gris 15W 100°	5000K	APQ-022	18,45€

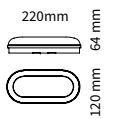

\* Led incluido



APLIQUE LED EXTERIOR CIRCULAR	Blanco 20W 100°	3200K	APQ-023	26,01€
APLIQUE LED EXTERIOR CIRCULAR	Blanco 20W 100°	4200K	APQ-024	26,01€
APLIQUE LED EXTERIOR CIRCULAR	Blanco 20W 100°	5000K	APQ-025	26,01€
APLIQUE LED EXTERIOR CIRCULAR	Gris 20W 100°	3200K	APQ-026	26,01€
APLIQUE LED EXTERIOR CIRCULAR	Gris 20W 100°	4200K	APQ-027	26,01€
APLIQUE LED EXTERIOR CIRCULAR	Gris 20W 100°	5000K	APQ-028	26,01€



Ø225mm

\* Led incluido



APLIQUE LED EXTERIOR RECTANGULAR	Gris 20W 100°	4200K	APQ-043	20,91€
APLIQUE LED EXTERIOR RECTANGULAR	Gris 20W 100°	3CCT	APQ-094	20,97€

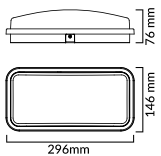

3 en 1 TRES TIPOS DE LUZ EN LA MISMA LUMINARIA

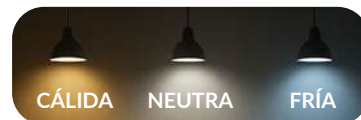



**APLIQUES EXTERIOR** 

**LED INCLUIDO**

**3 en 1 TRES TIPOS DE LUZ**  
EN LA MISMA LUMINARIA



**SERIE PLASTIC**

**ALTA LUMINOSIDAD**

**ESPECIAL FACHADA**



\* Led incluido

			K°	Ref	PVPR	
APLIQUE EXTERIOR REDONDO	15W	100°	3CCT	APQ-381	21,18 €	↓
APLIQUE EXTERIOR CUADRADO	15W	100°	3CCT	APQ-382	21,18 €	↓

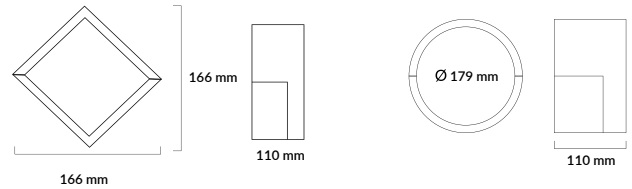

**3 en 1 TRES TIPOS DE LUZ**  
EN LA MISMA LUMINARIA





**SERIE PLASTIC**

**ALTA LUMINOSIDAD**

**ESPECIAL FACHADA**



\* Led incluido

			K°	Ref	PVPR
APLIQUE LED REDONDO	Gris - 15W	CCT		APQ-486	20,22 €
APLIQUE LED CUADRADO	Gris - 15W	CCT		APQ-487	20,22 €

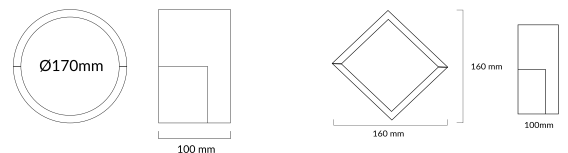

\* Según la nueva normativa ERP ha habido un cambio en la medición de Lúmenes y vatios, pero sigue emitiendo la misma cantidad de luz. A medida que vayan entrando los nuevos modelos con ERP se irá actualizando en catálogo y cajas de color. Puede haber variación respecto la caja del producto (comprobar en ficha técnica), todos los datos en catálogo están correctos salvo error tipográfico.

## APLIQUES EXTERIOR

IP 65

LED INCLUIDO



SERIE PLASTIC

ALTA LUMINOSIDAD

ESPECIAL FACHADA

\* Led incluido



APLIQUE LED REDONDO *Gris - 15W*  
 APLIQUE LED CUADRADO *Gris - 15W*

K°

Ref

PVPR

4200K APQ-046 17,70€  
 4200K APQ-047 17,70€

15w 1500 Lm 100° 230 v IP 65 20

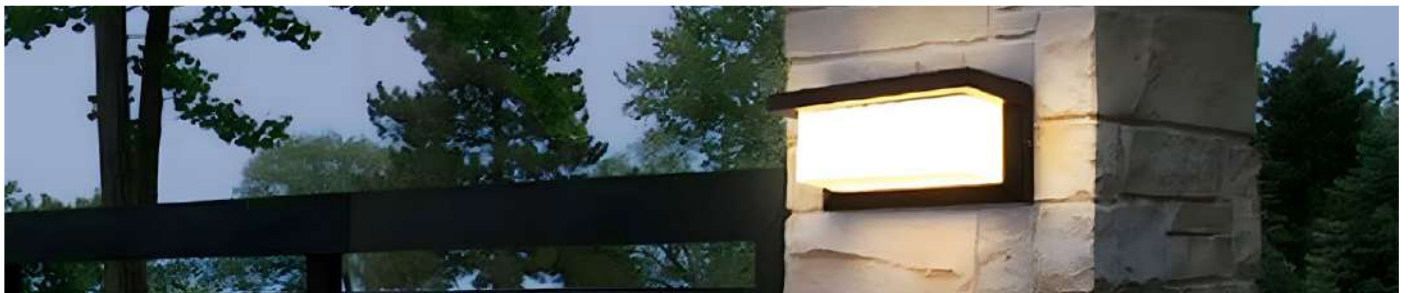
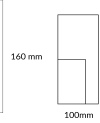
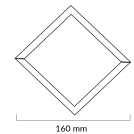
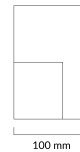

3 en 1 TRES TIPOS DE LUZ EN LA MISMA LUMINARIA

CÁLIDA NEUTRA FRÍA



Switch 3CCT



SERIE PLASTIC

ALTA LUMINOSIDAD

ESPECIAL FACHADA



\* Led incluido

APLIQUE EXTERIOR RECTANGULAR

24W 100°

K°

Ref

PVPR

3CCT APQ-383 30,24 €

24w 1800 Lm 100° 230 v IP 65 3CCT

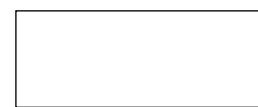

325 mm

135 mm



105 mm



**LED INCLUIDO**

**Serie APLIQUES ESCALERA exterior IP65**



**LED INCLUIDO**

**SERIE ALUMINIO**

				Ref	PVPR
APLIQUE LED EXTERIOR EMPOTRADO	Negro	3W	2700K	APQ-506	11,70€

3w
230v
IP 65
↓

Cubierta protectora extraíble  
Corte: 48x48x46mm

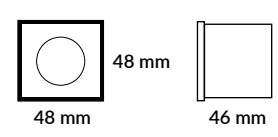
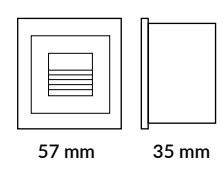

\* Según la nueva normativa ERP ha habido un cambio en la medición de Lúmenes y vatios, pero sigue emitiendo la misma cantidad de luz. A medida que vayan entrando los nuevos modelos con ERP se irá actualizando en catálogo y cajas de color. Puede haber variación respecto la caja del producto (comprobar en ficha técnica), todos los datos en catálogo están correctos salvo error tipográfico.

## APLIQUES EXTERIOR ESCALERA

IP 65

LED INCLUIDO



NEW!



LED INCLUIDO

SERIE ALUMINIO

					Ref	PVPR
APLIQUE LED EXTERIOR CUADRADO	Negro	5W	2700K		APQ-505	27,75€
APLIQUE LED EXTERIOR CUADRADO	Negro	5W	3200K		APQ-497	27,75€
APLIQUE LED EXTERIOR CUADRADO	Negro	5W	4200K		APQ-498	27,75€

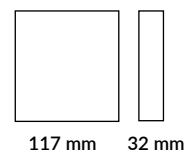

NEW!



LED INCLUIDO

SERIE ALUMINIO

					Ref	PVPR
APLIQUE LED EXTERIOR CUADRADO	Negro	5W	3200K		APQ-499	36,24€
APLIQUE LED EXTERIOR CUADRADO	Negro	5W	4200K		APQ-500	36,24€



- Distancia detección 3 mts
- Tiempo encendido 30-40 seg

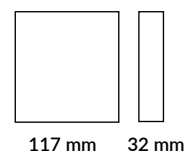



**APLIQUES  
EXTERIOR  
ESCALERA**

IP  
65

**LED INCLUIDO**

**NEW!**



LED INCLUIDO

**SERIE ALUMINIO**

					Ref	PVPR
APLIQUE LED EXTERIOR CUADRADO	Negro	3W	2700K	●	APQ-528	25,86€
APLIQUE LED EXTERIOR CUADRADO	Negro	3W	3200K	●	APQ-525	25,86€
APLIQUE LED EXTERIOR CUADRADO	Negro	3W	4200K	●	APQ-526	25,86€
APLIQUE LED EXTERIOR CUADRADO	Negro	3W	5000K	●	APQ-527	25,86€

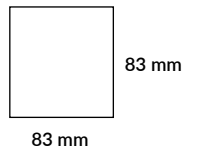



**APLIQUES  
EXTERIOR  
ESCALERA**



**LED INCLUIDO**

**NEW!**



**LED INCLUIDO**

**SERIE ALUMINIO**

					Ref	PVPR
APLIQUE LED EXTERIOR REDONDO	Negro	3W	3200K	●	APQ-493	25,95€
APLIQUE LED EXTERIOR REDONDO	Negro	3W	4200K	●	APQ-494	25,95€



117 mm 32 mm

**NEW!**



**LED INCLUIDO**

**SERIE ALUMINIO**

					Ref	PVPR
APLIQUE LED EXTERIOR REDONDO	Negro	3W	3200K	●	APQ-495	34,50€
APLIQUE LED EXTERIOR REDONDO	Negro	3W	4200K	●	APQ-496	34,50€



- Distancia detección 3 mts
- Tiempo encendido 30-40 seg



117 mm 32 mm



**APLIQUES  
EXTERIOR  
ESCALERA**



**LED INCLUIDO**



**NEW!**

**LED INCLUIDO**

**SERIE ALUMINIO**

					Ref	PVPR
APLIQUE LED EXTERIOR REDONDO	Negro	3W	3200K	●	APQ-489	23,76€
APLIQUE LED EXTERIOR REDONDO	Negro	3W	4200K	●	APQ-490	23,76€



83 mm 26 mm



**NEW!**

**LED INCLUIDO**

**SERIE ALUMINIO**

					Ref	PVPR
APLIQUE LED EXTERIOR REDONDO	Negro	3W	3200K	●	APQ-491	32,34€
APLIQUE LED EXTERIOR REDONDO	Negro	3W	4200K	●	APQ-492	32,34€



- Distancia detección 3 mts
- Tiempo encendido 30-40 seg

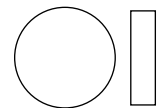

83 mm 26 mm

\* Según la nueva normativa ERP ha habido un cambio en la medición de Lúmenes y vatios, pero sigue emitiendo la misma cantidad de luz. A medida que vayan entrando los nuevos modelos con ERP se irá actualizando en catálogo y cajas de color. Puede haber variación respecto la caja del producto (comprobar en ficha técnica), todos los datos en catálogo están correctos salvo error tipográfico.

# Serie Apliques jardin



PARA  
**BOMBILLA E27**



**NEW!**



## SERIE ALUMINIO

Lámpara **NO INCLUIDA** - PANEL CRISTAL

LÁMPARA DE PIE EXTERIOR	CUADRADO	PARA Lámpara E27	60CM ALTURA	Ref	PVPR
				APQ-485	47,82€



350mm



**APLIQUES  
EXTERIOR  
JARDIN**



PARA  
**BOMBILLA E27**



**NEW!**



**SERIE ALUMINIO**

Lámpara **NO INCLUIDA**

				Ref	PVPR	
LÁMPARA SUELO EXTERIOR	CIRCULAR	PARA Lámpara E27	60CM ALTURA	APQ-307	56,82€	↓
LÁMPARA SUELO EXTERIOR	CUADRADO	PARA Lámpara E27	60CM ALTURA	APQ-308	56,82€	↓



60 cm

CIRCULAR CUADRADO

**NEW!**



PARA  
**DICROICA GU10**



**SERIE ALUMINIO**

Lámpara **NO INCLUIDA**

				Ref	PVPR
LÁMPARA SUELO EXTERIOR	CUADRADO	PARA Lámpara GU10	60CM ALTURA	APQ-302	56,70€



60 cm

\* Según la nueva normativa ERP ha habido un cambio en la medición de Lúmenes y vatios, pero sigue emitiendo la misma cantidad de luz. A medida que vayan entrando los nuevos modelos con ERP se irá actualizando en catálogo y cajas de color. Puede haber variación respecto la caja del producto (comprobar en ficha técnica), todos los datos en catálogo están correctos salvo error tipográfico.



## Serie picas de jardin

**LED INCLUIDO**



Led integrado - Incluye cable de alimentación

	K°	Ref	PVPR
FOCO PICA JARDIN	3200K	ACLED-354	9,06 €
FOCO PICA JARDIN	5000K	ACLED-355	9,06 €



**MATERIAL PC**

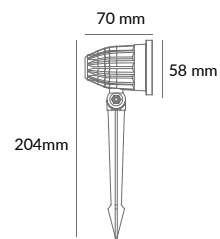

**NO INCLUYEN Lámparas**

Incluye cable alimentación de 1,5mts. con enchufe de seguridad.

	Ref	PVPR
Pica de jardin para <b>PAR38</b> <i>Máximo 150w E27</i>	ACLED-065	23,64€
Pica de jardin para <b>2 x PAR38</b> <i>Máximo 150w 2 x E27</i>	ACLED-066	26,85€



**MATERIAL PC**

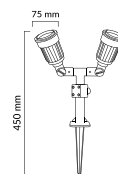

ACLED-065

ACLED-066



No incluye cable de alimentación

Pica de jardin para <b>PAR38</b> <b>NEGRO</b>	ACLED-174	15,42€
---	-----------	--------



**MATERIAL PC**

**DISEÑO ROBUSTO**

Tierra

Pared

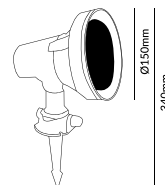
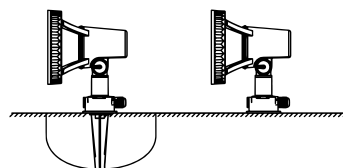

Incluye cable de alimentación

Pica de jardin para <b>GU10</b> <b>NEGRO</b>	ACLED-173	30,54€
--	-----------	--------



**SERIE ALUMINIO**

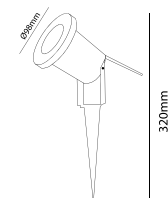

**NEW!**



No incluye cable de alimentación

Pica de jardin para <b>GU10</b> <b>NEGRO</b>	ACLED-356	16,50€
--	-----------	--------



**MATERIAL PLS**

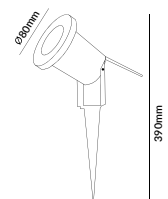



# Serie foco de suelo

PARA  
**DICROICA GU10**



## FOCO EMPOTRABLE **EXTERIOR**



**SERIE ALUMINIO**

**NEW!**



-Para Dicroicas GU10-MR16 - Lámpara no incluida - Incluye portalámparas

FOCO EMPOTRABLE SUELO REDONDO	GU10	Ref	PVPR
		APQ-078	35,76€

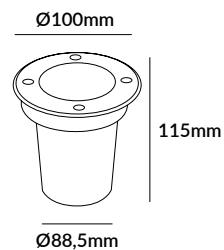

-Para Dicroicas GU10-MR16 - Lámpara no incluida - Incluye portalámparas

FOCO EMPOTRABLE SUELO CUADRADO	GU10	Ref	PVPR
		APQ-067	39,15€

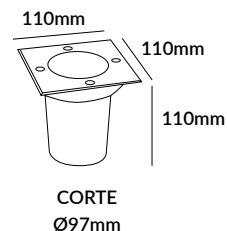

\* Según la nueva normativa ERP ha habido un cambio en la medición de Lúmenes y vatios, pero sigue emitiendo la misma cantidad de luz. A medida que vayan entrando los nuevos modelos con ERP se irá actualizando en catálogo y cajas de color. Puede haber variación respecto la caja del producto (comprobar en ficha técnica), todos los datos en catálogo están correctos salvo error tipográfico.





**Serie Downlight**

---



**SERIE**  
**DOWNLIGHT 3CCT**  
 SUPERFICIE/EMPOTRAR  
 BLANCO /NEGRO MATE



Used  
**SAMSUNG**  
 LED Chips

**AHORRA ESPACIO**  
**EN TU ALMACÉN**

AJUSTE DE COLORES  
 Cambia fácilmente el color desde el switch

**3 en 1** TRES TIPOS DE LUZ  
 EN LA MISMA LUMINARIA



Switch  
**3CCT**



## · DOWNLIGHT SUPERFICIE

SAMSUNG LED Inside

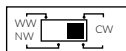

SWITCH 3CCT EN LED DRIVER



3CCT

NEW!



					K°	Ref	PVPR	
DOWNLIGHT SUPERFICIE CIRCULAR	6W	400Lm	30	3CCT	30	DOW-463	14,16 €	↓
DOWNLIGHT SUPERFICIE CIRCULAR	12W	800Lm	20	3CCT	30	DOW-464	22,14 €	↓
DOWNLIGHT SUPERFICIE CIRCULAR	18W	1400Lm	20	3CCT	30	DOW-465	25,32 €	↓

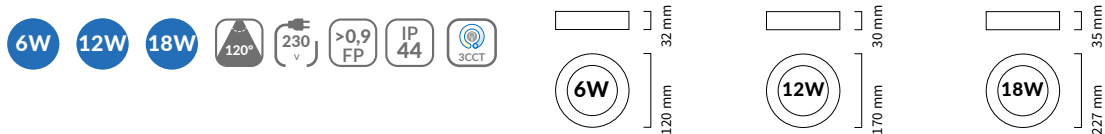

NEW!



					K°	Ref	PVPR	
DOWNLIGHT SUPERFICIE CIRCULAR	6W	400Lm	30	3CCT	30	DOW-473		
DOWNLIGHT SUPERFICIE CIRCULAR	12W	800Lm	20	3CCT	30	DOW-474		
DOWNLIGHT SUPERFICIE CIRCULAR	18W	1400Lm	20	3CCT	30	DOW-466	27,36 €	↓

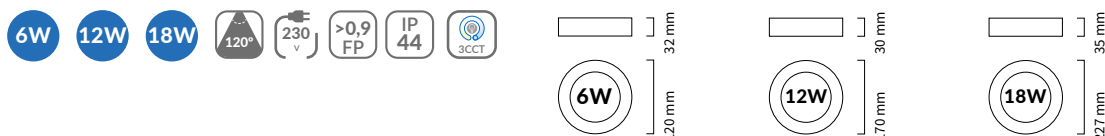

## · DOWNLIGHT EMPOTRADO

SAMSUNG LED Inside

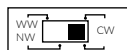

SWITCH 3CCT EN LED DRIVER



3CCT

NEW!



					K°	Ref	PVPR	
DOWNLIGHT EMPOTRAR CIRCULAR	6W	400Lm		3CCT	30	DOW-467	11,70 €	↓
DOWNLIGHT EMPOTRAR CIRCULAR	12W	800Lm		3CCT	30	DOW-468	17,25 €	↓
DOWNLIGHT EMPOTRAR CIRCULAR	18W	1400Lm		3CCT	30	DOW-469	20,85 €	↓

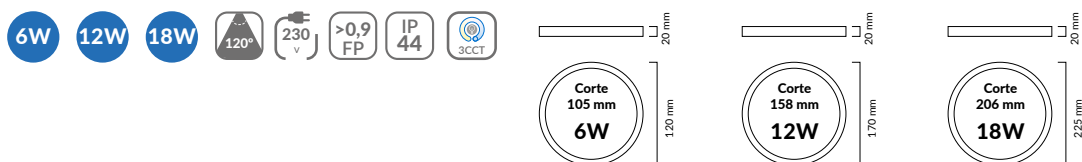

					K°	Ref	PVPR	
DOWNLIGHT 3CCT	CIRCULAR BLANCO	Empotrado 6w		3CCT	30	DOW-315	11,25€	↓
DOWNLIGHT 3CCT	CIRCULAR BLANCO	Empotrado 12w		3CCT	30	DOW-316	16,80€	↓
DOWNLIGHT 3CCT	CIRCULAR BLANCO	Empotrado 18w		3CCT	30	DOW-317	20,40€	↓

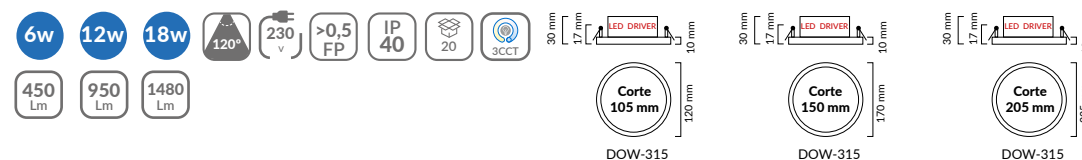

DOWNLIGHT MINI BLANCO 7w 3CCT DOW-332 11,76€

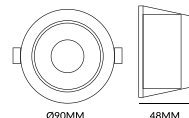

\* Según la nueva normativa ERP ha habido un cambio en la medición de Lúmenes y vatios, pero sigue emitiendo la misma cantidad de luz.

A medida que vayan entrando los nuevos modelos con ERP se irá actualizando en catálogo y cajas de color.

Puede haber variación respecto la caja del producto (comprobar en ficha técnica), todos los datos en catálogo están correctos salvo error tipográfico.



## DOWNLIGHT TÉCNICO ESPECIAL CENTROS EDUCATIVOS

Gracias al **UGR<19** lo hace ideal para espacios donde hay que realizar tareas de larga duración, ya sea centros educativos, oficinas, áreas de trabajo. No causa deslumbramiento aportando un **comfort visual**.



## DOWNLIGHT 3CCT SWITCH DIMMABLE

3 en 1 TRES TIPOS DE LUZ EN LA MISMA LUMINARIA



DISEÑO MODERNO



### · DOWNLIGHT EMPOTRADO

K° Ref PVPR

DOWNLIGHT CIRCULAR REGULABLE TRIAC *Empotrado 15w 3CCT* DOW-458 21,66€

**NEW!** DOWNLIGHT CIRCULAR REGULABLE TRIAC *Empotrado 25w 3CCT* DOW-323 31,50€

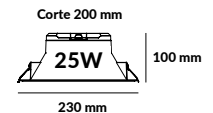
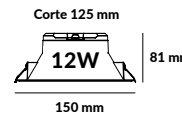

### Downlight dimmable con las pastillas:



tuya

CONTR-063 - 300w -  
Regulador para varios pulsadores 60,66€



CONTR-022 - 360w -  
Regulador para varios pulsadores 52,62€



# DOWNLIGHT 3CCT

## CON CORTE AJUSTABLE

**3 en 1** TRES TIPOS DE LUZ  
EN LA MISMA LUMINARIA



### · DOWNLIGHT SUPERFICIE



#### Corte Ajustable

DOW-333: 50 - 180 mm  
DOW-334: 50 - 260 mm

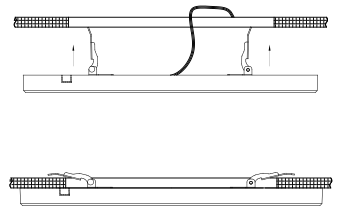

**NEW PRICE!!**



	K°	Ref	PVPR	
DOWNLIGHT CORTE AJUSTABLE 50 - 180mm	22cm	18w	1850Lm	3CCT
DOW-333	18,81€	18mm	Ø220mm	
DOWNLIGHT CORTE AJUSTABLE 50 - 260mm	29,8cm	22w	2270Lm	3CCT
DOW-334	43,68€	17,8 mm	Ø298 mm	



\* Según la nueva normativa ERP ha habido un cambio en la medición de Lúmenes y vatios, pero sigue emitiendo la misma cantidad de luz. A medida que vayan entrando los nuevos modelos con ERP se irá actualizando en catálogo y cajas de color. Puede haber variación respecto la caja del producto (comprobar en ficha técnica), todos los datos en catálogo están correctos salvo error tipográfico.



## Serie Downlight - Estanco IP65

### DOWNLIGHTS EXTERIOR IP 65



NEW!

		K°	Ref	PVPR
DOWNLIGHT EMPOTRABLE CIRCULAR	15W 1200Lm	3200K	DOW-459	11,04 €
DOWNLIGHT EMPOTRABLE CIRCULAR	15W 1200Lm	4200K	DOW-460	11,04 €

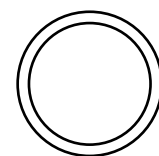

Ø170mm

Corte 150mm

		K°	Ref	PVPR
DOWNLIGHT EMPOTRABLE CIRCULAR	20W 2000Lm	3200K	DOW-461	14,70 €
DOWNLIGHT EMPOTRABLE CIRCULAR	20W 2000Lm	4200K	DOW-462	14,70 €

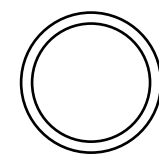

Ø225mm

Corte 200mm

### ACCESORIO SUPERFICIE

PVPR

ACLED-465  
ACCESORIO DE MONTAJE SUPERFICIE  
PARA DOW-459/460 2,58 €

ACLED-466  
ACCESORIO DE MONTAJE SUPERFICIE  
PARA DOW-461/462 3,60 €

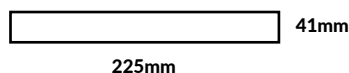
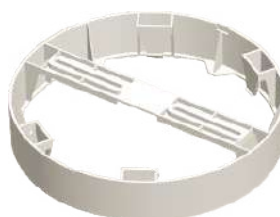

225mm

41mm



DOWNLIGHTS  
**EXTERIOR**



**3**POTENCIAS  
18w/24w/30w

**3 en 1** TRES TIPOS DE LUZ  
EN LA MISMA LUMINARIA

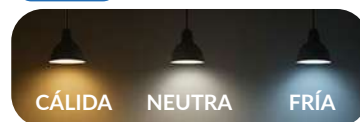

**NEW!**

	K°	Ref	PVPR
DOWNLIGHT SUPERFICIE <i>Blanco</i> IP65 18-24-30w	3 CCT	DOW-470	41,85€
DOWNLIGHT SUPERFICIE <i>Negro</i> IP65 18-24-30w	3 CCT	DOW-471	41,85€

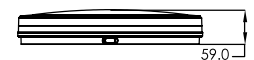
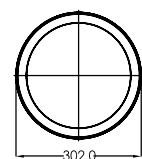

# Serie Downlight - WIFI RGB - 3CCT

## Downlight domótico



3 en 1 TRES TIPOS DE LUZ EN LA MISMA LUMINARIA



2 MODOS DE CONTROL WIFI + CONTROLADOR RF 2.4Ghz



COMPATIBLE CON APP **tuya**

Incluye mando a distancia

DESCARGAR FICHA TÉCNICA CON VIDEO VINCULACIÓN



K° Ref PVPR

DOWNLIGHT CIRCULAR PLANO	RGB + 3CCT	WiFi	Empotrado 18w	RGB + 3CCT	↓	DOW-341	75,90€
DOWNLIGHT CIRCULAR SUPERFICIE	RGB + 3CCT	WiFi	Superficie 18w	RGB + 3CCT	↓	DOW-336	75,90€

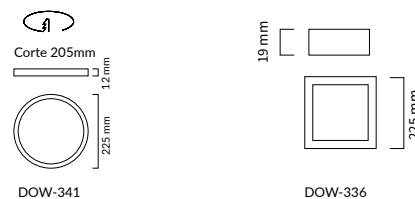

## Serie Downlight Empotrado

### Downlight SLIM BACK-LIGHT

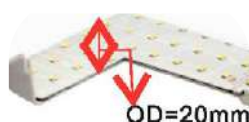

Downlight con sistema **BACK-LIGHT**  
**NO PRODUCE DESLUMBRAMIENTO**

LED DRIVER  
ALTA CALIDAD

ALTA  
LUMINOSIDAD

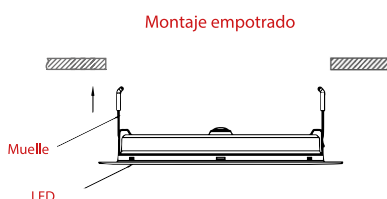

ALTURA LED DRIVER: 2,2 cm

SE VENDE EN EMBALAJES COMPLETOS 20

			Kº	Ref	PVPR
DOWNLIGHT PLANO SUPER-SLIM BACK-LIGHT	8W 720Lm	3200K	●	DOW-440	6,06€
DOWNLIGHT PLANO SUPER-SLIM BACK-LIGHT	8W 720Lm	4200K	●	DOW-441	6,06€
DOWNLIGHT PLANO SUPER-SLIM BACK-LIGHT	8W 720Lm	5000K	●	DOW-442	6,06€

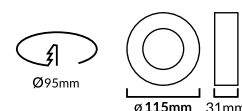

DOWNLIGHT PLANO SUPER-SLIM BACK-LIGHT	12W 1080Lm	3200K	●	DOW-443	7,56€
DOWNLIGHT PLANO SUPER-SLIM BACK-LIGHT	12W 1080Lm	4200K	●	DOW-444	7,56€
DOWNLIGHT PLANO SUPER-SLIM BACK-LIGHT	12W 1080Lm	5000K	●	DOW-445	7,56€

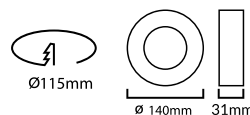

DOWNLIGHT PLANO SUPER-SLIM BACK-LIGHT	15W 1400Lm	3200K	●	DOW-446	9,06€
DOWNLIGHT PLANO SUPER-SLIM BACK-LIGHT	15W 1400Lm	4200K	●	DOW-447	9,06€
DOWNLIGHT PLANO SUPER-SLIM BACK-LIGHT	15W 1400Lm	5000K	●	DOW-448	9,06€

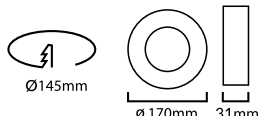

DOWNLIGHT PLANO SUPER-SLIM BACK-LIGHT	20W 2000Lm	3200K	●	DOW-457	13,62€
DOWNLIGHT PLANO SUPER-SLIM BACK-LIGHT	20W 2000Lm	4200K	●	DOW-449	13,62€
DOWNLIGHT PLANO SUPER-SLIM BACK-LIGHT	20W 2000Lm	5000K	●	DOW-450	13,62€

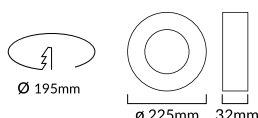



## · DOWNLIGHT EMPOTRADO

Para evitar incidencias en cualquier instalación, porfavor revisen las medidas de corte de cada producto.



Modelo	Material	Color	Potencia	Temperatura de Color	Referencia	PVP	Acción	Diagrama
DOWNLIGHT ELYOS	CIRCULAR CROMO MATE		Empotrado 6w	3200K	DOW-069	13,71€	↓	Corte 110 mm
DOWNLIGHT SAMSUNG	CIRCULAR CROMO MATE		Empotrado 6w	4200K	DOW-288	13,71€	↓	
DOWNLIGHT SAMSUNG	CIRCULAR CROMO MATE		Empotrado 6w	5000K	DOW-289	13,71€	↓	
DOWNLIGHT SAMSUNG	CIRCULAR BLANCO		Empotrado 6w	3200K	DOW-266	10,17€	↓	Corte 110 mm
DOWNLIGHT SAMSUNG	CIRCULAR BLANCO		Empotrado 6w	4200K	DOW-218	10,17€	↓	
DOWNLIGHT SAMSUNG	CIRCULAR BLANCO		Empotrado 6w	5000K	DOW-219	10,17€	↓	
DOWNLIGHT ELYOS	CIRCULAR ALU.BRUSH.		Empotrado 6w	3200K	DOW-177	13,71€	↓	Corte 110 mm
DOWNLIGHT SAMSUNG	CIRCULAR ALU.BRUSH.		Empotrado 6w	4200K	DOW-286	13,71€	↓	
DOWNLIGHT SAMSUNG	CIRCULAR ALU.BRUSH.		Empotrado 6w	5000K	DOW-287	13,71€	↓	
DOWNLIGHT ELYOS	CUADRADO BLANCO		Empotrado 6w	3200K	DOW-076	11,22€	↓	CORTE 110x110mm
DOWNLIGHT SAMSUNG	CUADRADO BLANCO		Empotrado 6w	4200K	DOW-262	11,22€	↓	
DOWNLIGHT SAMSUNG	CUADRADO BLANCO		Empotrado 6w	5000K	DOW-263	11,22€	↓	
DOWNLIGHT ELYOS	CUADRADO CROMO MATE		Empotrado 6w	3200K	DOW-079	12,66€	↓	Corte 110 mm
DOWNLIGHT ELYOS	CUADRADO CROMO MATE		Empotrado 6w	4200K	DOW-080	12,66€	↓	
DOWNLIGHT ELYOS	CUADRADO CROMO MATE		Empotrado 6w	5000K	DOW-081	12,66€	↓	
DOWNLIGHT SAMSUNG	CUADRADO ALU.BRUSH.		Empotrado 6w	3200K	DOW-312	15,48€	↓	Corte 110 mm
DOWNLIGHT ELYOS	CUADRADO ALU.BRUSH.		Empotrado 6w	4200K	DOW-181	15,39€	↓	
DOWNLIGHT ELYOS	CUADRADO ALU.BRUSH.		Empotrado 6w	5000K	DOW-182	15,39€	↓	

6w 470 Lm 120° 230 v >0,9 DF IP 44 40 30 DOW-266 DOW-218 DOW-219

Modelo	Material	Color	Potencia	Temperatura de Color	Referencia	PVP	Acción	Diagrama
DOWNLIGHT ELYOS	CIRCULAR CROMO MATE		Empotrado 12w	3200K	DOW-063	18,84€	↓	Corte 160 mm
DOWNLIGHT ELYOS	CIRCULAR CROMO MATE		Empotrado 12w	4200K	DOW-064	18,84€	↓	
DOWNLIGHT ELYOS	CIRCULAR CROMO MATE		Empotrado 12w	5000K	DOW-065	18,84€	↓	
DOWNLIGHT SAMSUNG	CIRCULAR BLANCO		Empotrado 12w	3200K	DOW-270	16,23€	↓	Corte 160 mm
DOWNLIGHT SAMSUNG	CIRCULAR BLANCO		Empotrado 12w	4200K	DOW-220	16,23€	↓	
DOWNLIGHT SAMSUNG	CIRCULAR BLANCO		Empotrado 12w	5000K	DOW-221	16,23€	↓	
DOWNLIGHT ELYOS	CIRCULAR ALU.BRUSH.		Empotrado 12w	3200K	DOW-171	18,93€	↓	Corte 160x160mm
DOWNLIGHT SAMSUNG	CIRCULAR ALU.BRUSH.		Empotrado 12w	4200K	DOW-294	21,93€	↓	
DOWNLIGHT SAMSUNG	CIRCULAR ALU.BRUSH.		Empotrado 12w	5000K	DOW-295	21,93€	↓	
DOWNLIGHT ELYOS	CUADRADO BLANCO		Empotrado 12w	3200K	DOW-082	16,74€	↓	Corte 160x160mm
DOWNLIGHT SAMSUNG	CUADRADO BLANCO	NEW	Empotrado 12w	4200K	DOW-299	16,74€	↓	
DOWNLIGHT SAMSUNG	CUADRADO BLANCO		Empotrado 12w	5000K	DOW-264	16,74€	↓	
DOWNLIGHT ELYOS	CUADRADO CROMO MATE		Empotrado 12w	3200K	DOW-085	17,07€	↓	Corte 160x160mm
DOWNLIGHT ELYOS	CUADRADO CROMO MATE		Empotrado 12w	4200K	DOW-086	17,07€	↓	
DOWNLIGHT ELYOS	CUADRADO CROMO MATE		Empotrado 12w	5000K	DOW-087	17,07€	↓	
DOWNLIGHT ELYOS	CUADRADO ALU.BRUSH.		Empotrado 12w	3200K	DOW-174	23,76€	↓	Corte 160x160mm
DOWNLIGHT ELYOS	CUADRADO ALU.BRUSH.		Empotrado 12w	4200K	DOW-175	23,76€	↓	
DOWNLIGHT ELYOS	CUADRADO ALU.BRUSH.		Empotrado 12w	5000K	DOW-176	23,76€	↓	

12w 860 Lm 120° 230 v >0,9 FP IP 44 30



DOWNLIGHT LITE CIRCULAR BLANCO *Empotrado 18w* 4200K DOW-158 13,14€

DOWNLIGHT LITE CIRCULAR BLANCO *Empotrado 18w* 5000K DOW-157 13,14€

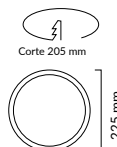

Used **SAMSUNG** LED Chips

DOWNLIGHT SAMSUNG CIRCULAR BLANCO *Empotrado 18w* 3200K DOW-272 19,38€

DOWNLIGHT SAMSUNG CIRCULAR BLANCO *Empotrado 18w* 4200K DOW-222 19,38€

DOWNLIGHT SAMSUNG CIRCULAR BLANCO *Empotrado 18w* 5000K DOW-223 19,38€

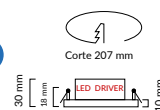

Used **SAMSUNG** LED Chips

DOWNLIGHT ELYOS CIRCULAR CROMO MATE *Empotrado 18w* 3200K DOW-099 23,94€

DOWNLIGHT SAMSUNG CIRCULAR CROMO MATE *Empotrado 18w* 4200K DOW-277 26,01€

DOWNLIGHT SAMSUNG CIRCULAR CROMO MATE *Empotrado 18w* 5000K DOW-275 26,01€



Used **SAMSUNG** LED Chips

DOWNLIGHT SAMSUNG CIRCULAR ALU. BRUSH. *Empotrado 18w* 3200K DOW-165 26,01€

DOWNLIGHT SAMSUNG CIRCULAR ALU. BRUSH. *Empotrado 18w* 4200K DOW-278 26,01€

DOWNLIGHT SAMSUNG CIRCULAR ALU. BRUSH. *Empotrado 18w* 5000K DOW-276 26,01€



Used **SAMSUNG** LED Chips

DOWNLIGHT SAMSUNG CUADRADO BLANCO *Empotrado 18w* 3200K DOW-225 26,61€

DOWNLIGHT SAMSUNG CUADRADO BLANCO *Empotrado 18w* 4200K DOW-228 26,61€

DOWNLIGHT SAMSUNG CUADRADO BLANCO *Empotrado 18w* 5000K DOW-229 26,61€



DOWNLIGHT ELYOS CUADRADO CROMO MATE *Empotrado 18w* 3200K DOW-137 24,72€

DOWNLIGHT ELYOS CUADRADO CROMO MATE *Empotrado 18w* 4200K DOW-042 24,72€

DOWNLIGHT SAMSUNG CUADRADO CROMO MATE *Empotrado 18w* 5000K DOW-304 28,20€

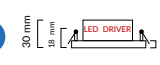

DOWNLIGHT ELYOS CUADRADO ALU. BRUSH. *Empotrado 18w* 3200K DOW-168 24,72€

DOWNLIGHT ELYOS CUADRADO ALU. BRUSH. *Empotrado 18w* 4200K DOW-169 24,72€

DOWNLIGHT ELYOS CUADRADO ALU. BRUSH. *Empotrado 18w* 5000K DOW-170 24,72€

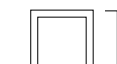

Used **SAMSUNG** LED Chips

DOWNLIGHT SAMSUNG CIRCULAR BLANCO *Superficie 24w* 4200K DOW-232 39,39€



Used **SAMSUNG** LED Chips

DOWNLIGHT SAMSUNG CIRCULAR BLANCO *Superficie 24w* 5000K DOW-233 39,39€

DOWNLIGHT SAMSUNG CUADRADO BLANCO *Superficie 24w* 4200K DOW-234 35,79€

DOWNLIGHT SAMSUNG CUADRADO BLANCO *Superficie 24w* 5000K DOW-235 35,79€

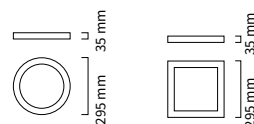

Used **SAMSUNG** LED Chips

DOWNLIGHT SAMSUNG CIRCULAR BLANCO **NEW** *Superficie 25w* 3200K DOW-350 40,44€



Used **SAMSUNG** LED Chips

DOWNLIGHT SAMSUNG CIRCULAR BLANCO *Superficie 25w* 4200K DOW-309 40,44€

DOWNLIGHT ELYOS CUADRADO BLANCO *Superficie 25w* 5000K DOW-094 40,44€

DOWNLIGHT ELYOS CIRCULAR CROMO MATE *Superficie 25w* 4200K DOW-138 49,29€

DOWNLIGHT ELYOS CIRCULAR CROMO MATE *Superficie 25w* 5000K DOW-139 49,29€

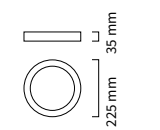

Used **SAMSUNG** LED Chips

DOWNLIGHT SAMSUNG CIRCULAR CROMO MATE *Empotrado 24w* 4200K DOW-307 30,93€



Used **SAMSUNG** LED Chips

DOWNLIGHT SAMSUNG CIRCULAR CROMO MATE *Empotrado 24w* 5000K DOW-308 30,93€

DOWNLIGHT SAMSUNG CIRCULAR BLANCO *Empotrado 25w* 3200K DOW-090 30,93€

DOWNLIGHT SAMSUNG CIRCULAR BLANCO *Empotrado 24w* 4200K DOW-305 26,67€

DOWNLIGHT SAMSUNG CIRCULAR BLANCO *Empotrado 24w* 5000K DOW-306 26,67€

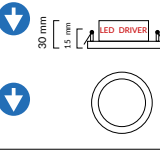

Used **SAMSUNG** LED Chips

DOWNLIGHT SAMSUNG CUADRADO BLANCO *Empotrado 25w* 4200K DOW-048 33,24€



Used **SAMSUNG** LED Chips

DOWNLIGHT SAMSUNG CUADRADO BLANCO *Empotrado 25w* 5000K DOW-049 33,24€

DOWNLIGHT ELYOS CUADRADO CROMO MATE *Empotrado 25w* 4200K DOW-050 48,78€

DOWNLIGHT ELYOS CUADRADO CROMO MATE *Empotrado 25w* 5000K DOW-051 48,78€

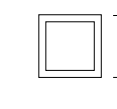

\* Según la nueva normativa ERP ha habido un cambio en la medición de Lúmenes y vatios, pero sigue emitiendo la misma cantidad de luz. A medida que vayan entrando los nuevos modelos con ERP se irá actualizando en catálogo y cajas de color. Puede haber variación respecto a la caja del producto (comprobar en ficha técnica), todos los datos en catálogo están correctos salvo error tipográfico.



OSRAM LED Chips  
LIFUD Led Driver

DOWNLIGHT PHOENIX CIRCULAR BLANCO	Empotrado 25w	3200K	DOW-191	50,22€
DOWNLIGHT PHOENIX CIRCULAR BLANCO	Empotrado 25w	4200K	DOW-192	50,22€
DOWNLIGHT PHOENIX CIRCULAR BLANCO	Empotrado 25w	5000K	DOW-193	50,22€



ALTURA CON LED DRIVER 58MM

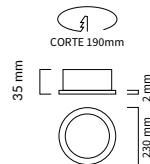

SAMSUNG LED Chips

DOWNLIGHT PRF SERIES SAMSUNG BLANCO	Empotrado 30w	3200K	DOW-216	31,65€
DOWNLIGHT PRF SERIES SAMSUNG BLANCO	Empotrado 30w	4200K	DOW-214	31,65€
DOWNLIGHT PRF SERIES SAMSUNG BLANCO	Empotrado 30w	5000K	DOW-215	31,65€



ALTURA CON LED DRIVER 77MM

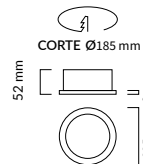

OSRAM LED Chips  
LIFUD Led Driver

DOWNLIGHT PHOENIX CIRCULAR BLANCO	Empotrado 42w	3200K	DOW-236	63,21€
DOWNLIGHT PHOENIX CIRCULAR BLANCO	Empotrado 42w	4200K	DOW-194	63,21€
DOWNLIGHT PHOENIX CIRCULAR BLANCO	Empotrado 42w	5000K	DOW-195	63,21€



ALTURA CON LED DRIVER 65MM

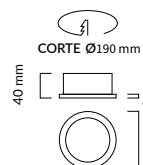

## • DOWNLIGHT SUPERFICIE

SAMSUNG LED Chips

			K°	Ref	PVPR
DOWNLIGHT ELYOS	CIRCULAR CROMO MATE	Superficie 6w	3200K	DOW-130	14,25€
DOWNLIGHT ELYOS	CIRCULAR CROMO MATE	Superficie 6w	4200K	DOW-131	14,25€
DOWNLIGHT ELYOS	CIRCULAR CROMO MATE	Superficie 6w	5000K	DOW-132	14,25€
DOWNLIGHT SAMSUNG	CIRCULAR BLANCO	Superficie 6w	3200K	DOW-283	14,79€
DOWNLIGHT SAMSUNG	CIRCULAR BLANCO	Superficie 6w	4200K	DOW-271	14,79€
DOWNLIGHT SAMSUNG	CIRCULAR BLANCO	Superficie 6w	5000K	DOW-284	14,79€
DOWNLIGHT ELYOS	CUADRADO CROMO MATE	Superficie 6w	3200K	DOW-140	15,12€
DOWNLIGHT ELYOS	CUADRADO CROMO MATE	Superficie 6w	4200K	DOW-141	15,12€
DOWNLIGHT ELYOS	CUADRADO CROMO MATE	Superficie 6w	5000K	DOW-142	15,12€
DOWNLIGHT ELYOS	CUADRADO BLANCO	Superficie 6w	3200K	DOW-103	12,78€
DOWNLIGHT ELYOS	CUADRADO BLANCO	Superficie 6w	4200K	DOW-104	12,78€
DOWNLIGHT ELYOS	CUADRADO BLANCO	Superficie 6w	5000K	DOW-105	12,78€

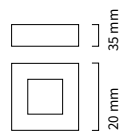
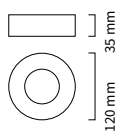

SAMSUNG LED Chips

DOWNLIGHT ELYOS	CIRCULAR CROMO MATE	Superficie 12w	3200K	DOW-133	18,75€
DOWNLIGHT SAMSUNG	CIRCULAR CROMO MATE	Superficie 12w	4200K	DOW-300	18,75€
DOWNLIGHT ELYOS	CIRCULAR CROMO MATE	Superficie 12w	5000K	DOW-135	18,75€
DOWNLIGHT SAMSUNG	CIRCULAR BLANCO	Superficie 12w	3200K	DOW-269	19,32€
DOWNLIGHT SAMSUNG	CIRCULAR BLANCO	Superficie 12w	4200K	DOW-230	19,32€
DOWNLIGHT SAMSUNG	CIRCULAR BLANCO	Superficie 12w	5000K	DOW-231	19,32€
DOWNLIGHT ELYOS	CUADRADO CROMO MATE	Superficie 12w	3200K	DOW-143	21,39€
DOWNLIGHT ELYOS	CUADRADO CROMO MATE	Superficie 12w	4200K	DOW-144	21,39€
DOWNLIGHT ELYOS	CUADRADO CROMO MATE	Superficie 12w	5000K	DOW-145	21,39€
DOWNLIGHT ELYOS	CUADRADO BLANCO	Superficie 12w	3200K	DOW-109	16,47€
DOWNLIGHT ELYOS	CUADRADO BLANCO	Superficie 12w	4200K	DOW-110	16,47€
DOWNLIGHT ELYOS	CUADRADO BLANCO	Superficie 12w	5000K	DOW-111	16,47€

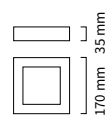
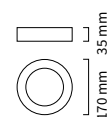



Used SAMSUNG LED Chips

Used SAMSUNG LED Chips

				K°	Ref	PVPR
DOWNLIGHT ELYOS	CIRCULAR ALUM. BRUSH.	Superficie 18w	3200K	●	DOW-162	32,64€
DOWNLIGHT ELYOS	CIRCULAR ALUM. BRUSH.	Superficie 18w	4200K	●	DOW-163	32,64€
DOWNLIGHT ELYOS	CIRCULAR ALUM. BRUSH.	Superficie 18w	5000K	●	DOW-164	32,64€
DOWNLIGHT SAMSUNG	CUADRADO BLANCO	Superficie 18w	3200K	●	DOW-265	28,26€
DOWNLIGHT SAMSUNG	CUADRADO BLANCO	Superficie 18w	4200K	●	DOW-267	28,26€
DOWNLIGHT SAMSUNG	CUADRADO BLANCO	Superficie 18w	5000K	●	DOW-268	28,26€
DOWNLIGHT ELYOS	CUADRADO CROMO MATE	Superficie 18w	3200K	●	DOW-187	30,30€
DOWNLIGHT ELYOS	CUADRADO CROMO MATE	Superficie 18w	4200K	●	DOW-046	30,30€
DOWNLIGHT ELYOS	CUADRADO CROMO MATE	Superficie 18w	5000K	●	DOW-047	30,30€
DOWNLIGHT ELYOS	CUADRADO ALUM. BRUSH.	Superficie 18w	3200K	●	DOW-188	35,94€
DOWNLIGHT ELYOS	CUADRADO ALUM. BRUSH.	Superficie 18w	4200K	●	DOW-189	35,94€
DOWNLIGHT ELYOS	CUADRADO ALUM. BRUSH.	Superficie 18w	5000K	●	DOW-190	35,94€
DOWNLIGHT ELYOS	CIRCULAR CROMO MATE	Superficie 18w	4200K	●	DOW-034	30,00€
DOWNLIGHT ELYOS	CIRCULAR CROMO MATE	Superficie 18w	5000K	●	DOW-035	30,00€
DOWNLIGHT SAMSUNG	CIRCULAR BLANCO	Superficie 18w	3200K	●	DOW-273	26,55€
DOWNLIGHT SAMSUNG	CIRCULAR BLANCO	Superficie 18w	4200K	●	DOW-226	26,55€
DOWNLIGHT SAMSUNG	CIRCULAR BLANCO	Superficie 18w	5000K	●	DOW-227	26,55€

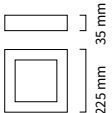
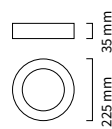

18w 1400 Lm 120° 230 v >0,9 FP IP 44 20

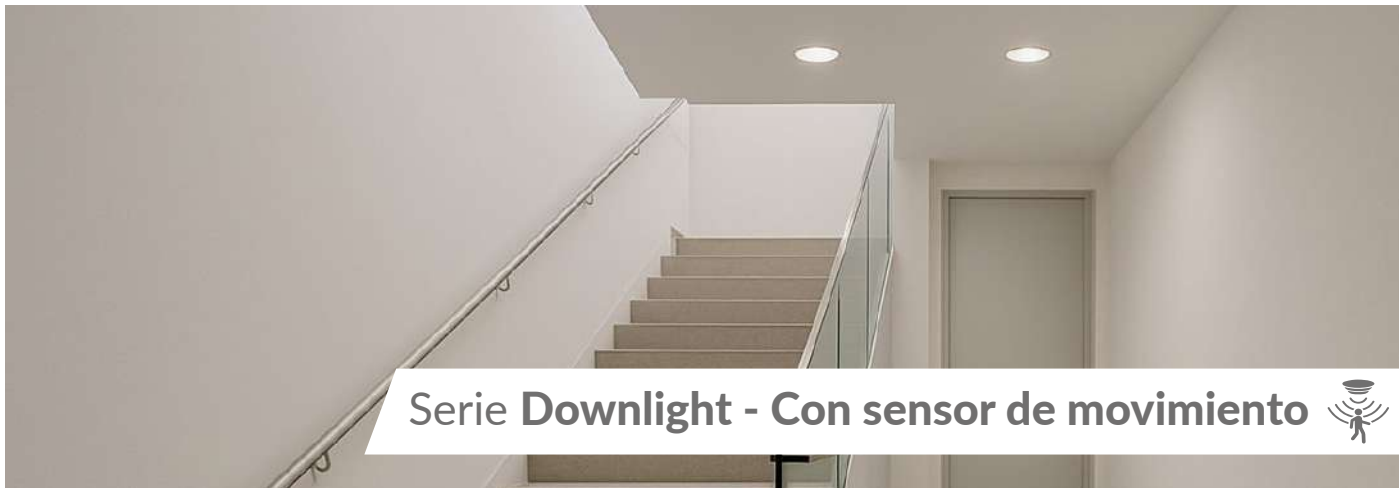

## Serie Downlight - Con sensor de movimiento



### 3 en 1 TRES TIPOS DE LUZ EN LA MISMA LUMINARIA



Switch 3CCT



			K°	Ref	PVPR
DOWNLIGHT SENSOR SUPERFICIE REDONDO	Blanco 18w	3CCT	●	DOW-472	37,35€

18w 1500 Lm 160° 230 v >0,9 FP IP 40 20

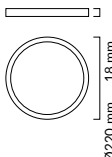

KOREAN CHIP SMD



			K°	Ref	PVPR
DOWNLIGHT SENSOR SUPERFICIE CIRCULAR	Blanco 21w	3200K	●	DOW-237	34,32€
DOWNLIGHT SENSOR SUPERFICIE CIRCULAR	Blanco 21w	4200K	●	DOW-238	34,32€
DOWNLIGHT SENSOR SUPERFICIE CIRCULAR	Blanco 21w	5000K	●	DOW-239	34,32€
DOWNLIGHT SENSOR SUPERFICIE CUADRADO	Blanco 21w	4200K	●	DOW-280	34,32€
DOWNLIGHT SENSOR SUPERFICIE CUADRADO	Blanco 21w	5000K	●	DOW-281	34,32€

21w 1680 Lm 160° 230 v >0,9 FP IP 20 20

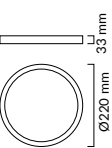

\* Según la nueva normativa ERP ha habido un cambio en la medición de Lúmenes y vatios, pero sigue emitiendo la misma cantidad de luz. A medida que vayan entrando los nuevos modelos con ERP se irá actualizando en catálogo y cajas de color. Puede haber variación respecto la caja del producto (comprobar en ficha técnica), todos los datos en catálogo estan correctos salvo error tipográfico.

RETROILUMINADO

## Serie Plafones

# Plafón led con anillo intercambiable

**3 en 1** TRES TIPOS DE LUZ  
EN LA MISMA LUMINARIA



CÁLIDA NEUTRA FRÍA



Switch  
**3CCT**



	K°	Ref	PVPR
PLAFON LED CIRCULAR 18w - 1850Lm ANILLO INTERCAMBIABLE	3CCT	DOW-451	29,10€
PLAFON LED CIRCULAR 24w - 2500Lm ANILLO INTERCAMBIABLE	3CCT	DOW-452	34,20€
PLAFON LED CIRCULAR 36w - 3830Lm ANILLO INTERCAMBIABLE	3CCT	DOW-482	

18w 24w 36w 1850 Lm 2500 Lm 3830 Lm 120° 230 v >0,5 FP IP 20 20

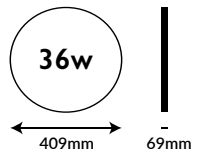
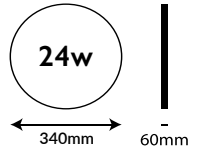
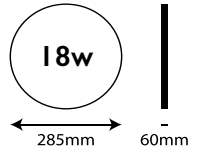

ARO INTERCAMBIABLE



Ref	PVPR
ACLED-375 18W - ANILLO BLANCO	4,02€
ACLED-376 18W - ANILLO NEGRO	4,02€
ACLED-377 18W - ANILLO MADERA	4,86€
ACLED-378 24W - ANILLO BLANCO	5,82€
ACLED-379 24W - ANILLO NEGRO	5,82€
ACLED-380 24W - ANILLO MADERA	6,48€
ACLED-528 36W - ANILLO BLANCO	
ACLED-529 36W - ANILLO NEGRO	
ACLED-530 36W - ANILLO MADERA	



	K°	Ref	PVPR
PLAFON LED CUADRADO 18w - 1850Lm ANILLO INTERCAMBIABLE	3CCT	DOW-454	34,20€
PLAFON LED CUADRADO 24w - 2500Lm ANILLO INTERCAMBIABLE	3CCT	DOW-455	36,30€
PLAFON LED CUADRADO 36w - 3830Lm ANILLO INTERCAMBIABLE	3CCT	DOW-456	57,60€

18w 24w 36w 1850 Lm 2500 Lm 3830 Lm 120° 230 v >0,5 FP IP 20 20

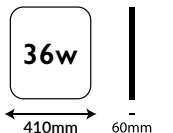
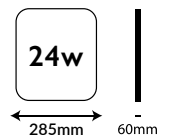
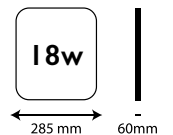

ARO INTERCAMBIABLE



Ref	PVPR
ACLED-384 18W - ANILLO BLANCO	4,14€
ACLED-385 18W - ANILLO NEGRO	4,14€
ACLED-386 18W - ANILLO MADERA	5,10€
ACLED-387 24W - ANILLO BLANCO	6,12€
ACLED-388 24W - ANILLO NEGRO	6,12€
ACLED-389 24W - ANILLO MADERA	6,90€
ACLED-390 36W - ANILLO BLANCO	7,68€
ACLED-391 36W - ANILLO NEGRO	7,68€
ACLED-392 36W - ANILLO MADERA	8,04€



RETROILUMINADO

PLAFÓN 3CCT SUPERFICIE RETROILUMINADO

3 en 1 TRES TIPOS DE LUZ EN LA MISMA LUMINARIA



PLAFÓN REDONDO	BLANCO RETROILUMINADO	18W
PLAFÓN REDONDO	BLANCO RETROILUMINADO	24W

18w 24w
1800 Lm 2400 Lm
120°
230 v
>0,5 FP
IP 40
20

K°	Ref	PVPR
3CCT	DOW-354	36,90€
3CCT	DOW-355	54,42€

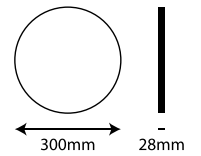

PLAFÓN CUADRADO	BLANCO RETROILUMINADO	18W
PLAFÓN CUADRADO	BLANCO RETROILUMINADO	24W

18w 24w
1800 Lm 2400 Lm
120°
230 v
>0,5 FP
IP 40
20

K°	Ref	PVPR
3CCT	DOW-356	38,34€
3CCT	DOW-357	56,22€

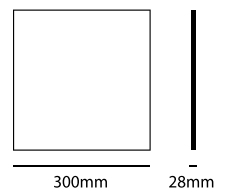



### 3 en 1 TRES TIPOS DE LUZ EN LA MISMA LUMINARIA

#### DOWNLIGHT PLAFÓN LED 3CCT

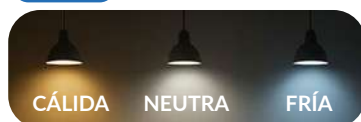

PLAFÓN LED CIRCULAR 3CCT **GRIS 20w** DOW-279 47,58€

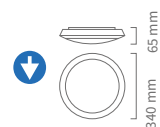

PLAFÓN LED CIRCULAR **1260 lm - 18w** 3CCT DOW-240 34,23€

PLAFÓN LED CIRCULAR **1680 lm - 24w** 3CCT DOW-241 41,58€

PLAFÓN LED CIRCULAR **2520 lm - 36w** 3CCT DOW-242 51,60€

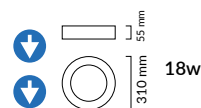

PLAFÓN LED CIRCULAR DIAMOND **1260 lm - 18w** 3CCT DOW-243 35,61€

PLAFÓN LED CIRCULAR DIAMOND **1680 lm - 24w** 3CCT DOW-244 42,99€

PLAFÓN LED CIRCULAR DIAMOND **2520 lm - 36w** 3CCT DOW-245 78,03€

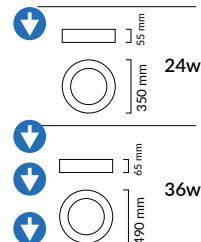

PLAFÓN LED CUADRADO **1260 lm - 18w** 3CCT DOW-246 41,85€

PLAFÓN LED CUADRADO **1680 lm - 24w** 3CCT DOW-247 47,85€

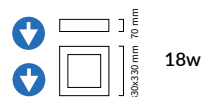

PLAFÓN LED CUADRADO DIAMOND **1260 lm - 18w** 3CCT DOW-249 47,01€

PLAFÓN LED CUADRADO DIAMOND **1680 lm - 24w** 3CCT DOW-250 56,16€

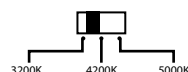

SWITCH 3CCT

## PLAFON CON SENSOR DE MOVIMIENTO HF

#### DOWNLIGHT PLAFÓN



2-2000lux - Máx. 2x20W - Distancia radio 2-10mts - 8seg-12min

PLAFÓN PARA LÁMPARA LED SENSOR HF 2 x E27 **2 x 20w** DOW-095 83,28€

2x 20w

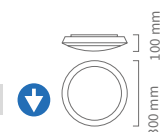



## Serie Plafones - Con sensor de movimiento



USOS: PASILLOS, ZONAS COMUNES,...

PLAFÓN LED SENSOR INFRARROJO



DOW-351 29,85€



- Luz ambiental: <3-2000LUX
- Tiempo: 10 SEC + 3 SEC (REGULABLE)
- Distancia: 6 metros
- Máx: 2 x 40w (E27)
- 360° Detección

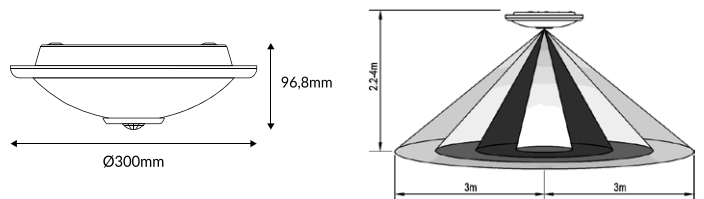

Añade la **BLED-270**  
Y haz el plafón con  
**sistema de emergencia**

2 CASQUILLO E27  
Para Lámpara ( NO INCLUIDA )



PLAFÓN CON SENSOR DE MOVIMIENTO 16W 1100Lm 4000K

PLAFÓN CON SENSOR DE MOVIMIENTO 16W 1100Lm 5500K

DOW-348 44,85€

DOW-349 44,85€

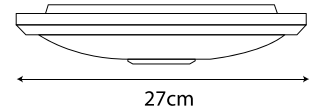
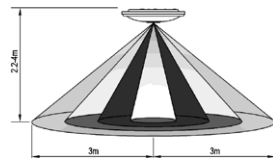

USOS: PASILLOS, ZONAS COMUNES,...

LED INCLUIDO - MONOCOLOR 4000K

K° Ref PVPR

PLAFÓN LED SENSOR PIR

4000K

DOW-379

17,82 €



PLAFÓN LED SENSOR PIR

4000K

DOW-380

24,24 €

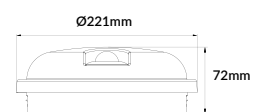
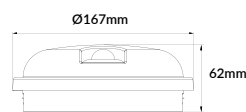

\* Según la nueva normativa ERP ha habido un cambio en la medición de Lúmenes y vatios, pero sigue emitiendo la misma cantidad de luz.

A medida que vayan entrando los nuevos modelos con ERP se irá actualizando en catálogo y cajas de color.

Puede haber variación respecto la caja del producto (comprobar en ficha técnica), todos los datos en catálogo están correctos salvo error tipográfico.

**Plafon 3CCT** - Con sensor de movimiento y sistema de emergencia



**SISTEMA DE EMERGENCIA INCLUIDO**

**3 POTENCIAS**  
12w/15w/18w

**3 en 1 TRES TIPOS DE LUZ EN LA MISMA LUMINARIA**



Switch **3CCT**



**ESPECIAL ESCALERAS**

**SISTEMA DE EMERGENCIA INCLUIDO** Potencia carga 20w 1500Lm

**GRAN AUTONOMÍA 120MIN**



Li-ion 3,2V 1800mAh

**LED INCLUIDO**

K° Ref

PLAFÓN CON SENSOR DE MOVIMIENTO Y EMERGENCIA **3CCT** DOW-360



**SENSOR PIR DE MOVIMIENTO**

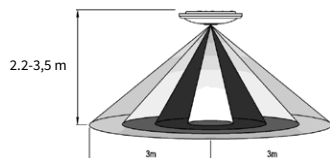



# Proyector **2 MODELOS DE PROYECTOR**

**3 en 1** TRES TIPOS DE LUZ  
EN LA MISMA LUMINARIA

## AJUSTA EL COLOR de luminosidad en cualquier momento que desees con el nuevo **PRY-138**

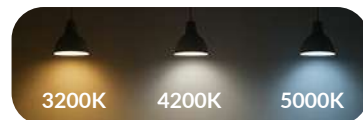

El **Foco Proyector Direccional Rectangular LED** combina a la perfección diseño, potencia y ahorro energético.

Estas cualidades lo convierten en una opción **muy interesante para** la iluminación de **espacios comerciales**.

Cuenta con un diseño que distribuye la luz en un ángulo de apertura de 120° que, en combinación con el difusor opal que incluye, proporciona una iluminación muy homogénea que minimiza los reflejos y el deslumbramiento.

Used  
**OSRAM**  
LED Chips

**High Efficiency**  
120lm/w



No incluye pilas  
en el precio

COMPATIBLE  
CON APP **tuya**

**PRY-138 - CON WIFI Y CONTROL REMOTO RF**

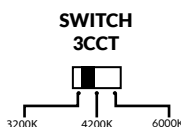

**PRY-138-2 - LED DRIVER CON SWITCH**



Used  
**OSRAM**  
LED Chips

K° Ref PVPR

PROYECTOR DOWNLIGHT RECTANGULAR BLANCO **WIFI - 40w** 3 CCT PRY-138 142,56€



PROYECTOR DOWNLIGHT RECTANGULAR BLANCO **40w** 3 CCT PRY-138-2 101,97€



### DOWNLIGHT **FOCO EMPOTRADO**

Used  
**OSRAM**  
LED Chips



DOWNLIGHT RECTANGULAR FOCO BLANCO **3000lm - 30w** 3200K DOW-183 108,33€

DOWNLIGHT RECTANGULAR FOCO BLANCO **3800lm - 50w** 3200K DOW-161 139,62€

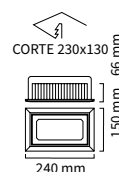

\* Según la nueva normativa ERP ha habido un cambio en la medición de Lúmenes y vatios, pero sigue emitiendo la misma cantidad de luz.

A medida que vayan entrando los nuevos modelos con ERP se irá actualizando en catálogo y cajas de color.

Puede haber variación respecto la caja del producto (comprobar en ficha técnica), todos los datos en catálogo están correctos salvo error tipográfico.





*Serie Luminaria Lineal*

---



# Luminaria lineal

3 en 1 TRES TIPOS DE LUZ EN LA MISMA LUMINARIA



NEW!

SERIE ALUMINIO

Luminaria lineal 3CCT - 2700K ● 4200K ● 5000K ●

LUMINARIA LINEAL SUSPENDIDA	36w 1200mm Blanco	3CCT	DOW-372	107,55€
LUMINARIA LINEAL SUSPENDIDA	36w 1200mm Negro	3CCT	DOW-373	107,55€



Longitud cable: 1,5metros

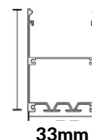

NEW PRICE!!

SERIE ALUMINIO

Luminaria lineal 3CCT - 3200K ● 4200K ● 5000K ●

LUMINARIA LINEAL SUSPENDIDA	36w 1200mm Blanco	3CCT	DOW-352	107,55€
LUMINARIA LINEAL SUSPENDIDA	36w 1200mm Negro	3CCT	DOW-353	107,55€



Longitud cable: 1,5metros

ACC. DE SUSPENSIÓN INCLUIDOS

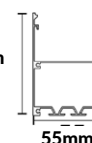
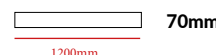

NEW!

SERIE ALUMINIO

Luminaria lineal MONOCOLOR

LUMINARIA LINEAL SUSPENDIDA	36w 1200mm Negro	4000K	DOW-370	80,25€
LUMINARIA LINEAL SUSPENDIDA	36w 1200mm Blanco	4000K	DOW-371	80,25€



Longitud cable: 1,5metros

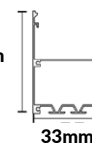
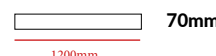

## Accesorios para lineales

Genera estructuras con estos accesorios

### Convierta su lineal en bañador de pared

Con esta **unión directa** conseguirás un diseño que es capaz de integrarse en diversos entornos arquitectónicos, con ello la luz se integra en el espacio y se convierten en una parte esencial del propio diseño de interiores.

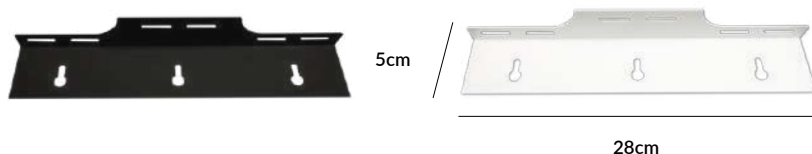

Ref	PVPR
ACLED-463 - Negro	5,16€
ACLED-468 - Blanco	5,16€

Ref	PVPR
ACLED-462	0,75€



**SERIE PLASTIC**



**3 en 1 TRES TIPOS DE LUZ EN LA MISMA LUMINARIA**



	K°	Ref	PVPR
LUMINARIA LINEAL SUSPENDIDA/SUPERFICIE <b>35w Negro</b>	3CCT	DOW-369	29,88€



**1200mm**

**FORMAS DE COLOCACIÓN:**

**SUPERFICIE**



**SUSPENDIDA**

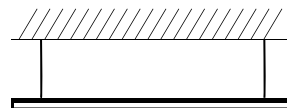

\* Según la nueva normativa ERP ha habido un cambio en la medición de Lúmenes y vatios, pero sigue emitiendo la misma cantidad de luz. A medida que vayan entrando los nuevos modelos con ERP se irá actualizando en catálogo y cajas de color. Puede haber variación respecto la caja del producto (comprobar en ficha técnica), todos los datos en catálogo están correctos salvo error tipográfico.



ACCESORIOS **DOWNLIGHT**



Ref PVPR



LED DRIVER PARA DOWNLIGHT **6w** AXLED-006 5,43€

LED DRIVER PARA DOWNLIGHT **12w** AXLED-007 7,23€



LED DRIVER PARA DOWNLIGHT **18w** AXLED-008 7,95€



LED DRIVER PARA DOWNLIGHT **25w** AXLED-009 10,80€

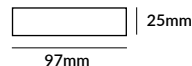

LED DRIVER **DIMMABLE TRIAC** PARA DOWNLIGHT **6w** AXLED-016 8,67€

LED DRIVER **DIMMABLE TRIAC** PARA DOWNLIGHT **12w** AXLED-015 8,67€

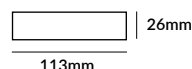

LED DRIVER **DIMMABLE TRIAC** PARA DOWNLIGHT **18w** AXLED-004 27,12€

LED DRIVER **DIMMABLE TRIAC** PARA DOWNLIGHT **24w** AXLED-022 35,94€



LED DRIVER **DIMMABLE TRIAC** PARA DOWNLIGHT **25w** AXLED-005 35,94€

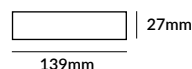

**FUNCIONAMIENTO** **BOTÓN ON REGULACIÓN +**  
**REGULACIÓN PULSANDO EL BOTÓN** **BOTÓN OFF REGULACIÓN -**



MANDO PARA PASTILLA CONTR-022 **4 Zonas 2.4Ghz** CONTR-036 39,57€



CIRCULAR LED COB **20W 120°** BLED-025 63,21€



LED DRIVERS **DIMMABLE TRIAC** PARA DOWNLIGHT PHOENIX **25W** AXLED-020 35,94€



LED DRIVERS **DIMMABLE TRIAC** PARA DOWNLIGHT PHOENIX **42W** AXLED-021 47,31€



**LED SPD-20-240P**  
Protege sobretensiones de hasta 20kA

PROTECTOR SOBRETENSIÓN TRANSITORIO PARA LED AXLED-011 54,00€

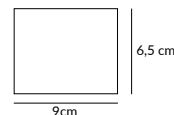

Con AUTOTEST Homologado

KIT DE EMERGENCIA PARA DOWNLIGHTS Y PANEL LED EMR-026 69,60€

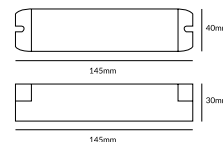

Convierta y controle los downlights dimmables en **WiFi** y **WiFi regulable** con las pastillas 

COMPATIBLE CON APP **tuya**

Para más información consulte la **pág. 282**



Para interruptor simple, conmutado y cruce



PASTILLA INTERRUPTOR MINI LED **WiFi 300W LED**  Ref: CONTR-054 PVPR: 41,91€ **tuya**

230 V -



No apta para instalaciones conmutables

PASTILLA INTERRUPTOR MINI MULTIFUNCIÓN **WiFi 300W LED**  Ref: CONTR-082 PVPR: 29,85€ **tuya**

230 V -



Para DOBLE interruptor, interruptor partido y conmutado

PASTILLA DOBLE INTERRUPTOR LED **WiFi 2 X 150W**  Ref: CONTR-042 PVPR: 56,31€ **tuya**

230 V -

Disponible para varios pulsadores



Para varios pulsadores **REGULACIÓN TRIAC** 

PASTILLA **DIMMABLE TRIAC** **WiFi 300W LED** **WiFi 300W LED**  Ref: CONTR-063 PVPR: 60,66€ **tuya**

230 V -



PASTILLA TELERRUPTOR MINI **WiFi 16A 230V - 300W LED**  Ref: CONTR-071 PVPR: 45,06€ **tuya**

230 V -

NEW!



**REGULACIÓN TRIAC**  **DIMMABLE 0-100% SIN PARPADEO** 

CONTROLADOR **DIMMABLE TRIAC** **WiFi PULSADOR** **WiFi 500W LED** Ref: CONTR-096 PVPR: 84,30€ **tuya**

230 V - · CONEXIÓN **WiFi**, 2,4Ghz, **BLUETOOTH** / CONTROL REMOTO 2,4Ghz

NEW!



PASTILLA **DIMMABLE TRIAC** **WiFi RF UART HOLE** **200W**  Ref: CONTR-104 PVPR: 58,50€ **tuya**

230 V -



Accesorio control remoto pulsador dimmable  
CONTR-105 (No incluido) Ref: CONTR-105 PVPR: 14,43€

NEW!



PASTILLA ON/OFF **WiFi RF UART HOLE** **250W** Ref: CONTR-117 **tuya**

230 V -



Mando control remoto ON/OFF  
CONTR-118 (No incluido) Ref: CONTR-118

NO DISPONE DE **WiFi**



PASTILLA PULSADOR CON EFECTO MEMORIA - FUNCIONA PARA VARIOS PULSADORES - NO DISPONE DE **WiFi**

PASTILLA **DIMMABLE TRIAC** POR PULSADOR  **MÁX 200W**  Ref: CONTR-022 PVPR: 52,62€



CONTR-036 CONTR-056

COMPATIBLE CON MANDO CONTR-036 Y CONTR-056

**REGULACIÓN TRIAC** 

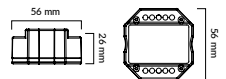

PASTILLA **DIMMABLE TRIAC** LED  **SIN NEUTRO** **MÁX 250W** Ref: CONTR-083 PVPR: 55,02 €

Este dimmer LED está diseñado para el control de lámparas LED regulables de hasta 250W. Con características de diseño compacto, brillo ajustable, potencia y memoria de ajuste de luz, es fácil de instalar y operar. 

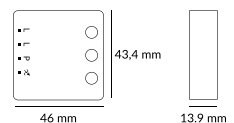

**REGULACIÓN TRIAC** 

- Tamaño compacto
- Sin ruido
- Regulación del borde de salida
- No necesita línea neutra
- Ideal para reequipamiento
- Luminosidad y velocidad de regulación regulables
- Memoria de potencia y luminosidad

- REGULACIÓN TRIAC
- NO DISPONE DE **WiFi**
- NO APTA PARA INSTALACIONES CONMUTADAS
- SE PUEDE USAR CON PULSADORES EN PARALELO

\* Según la nueva normativa ERP ha habido un cambio en la medición de Lúmenes y vatios, pero sigue emitiendo la misma cantidad de luz.

A medida que vayan entrando los nuevos modelos con ERP se irá actualizando en catálogo y cajas de color.

Puede haber variación respecto la caja del producto (comprobar en ficha técnica), todos los datos en catálogo están correctos salvo error tipográfico.





*Serie* **Track light**

---

## Serie Track light - Aluminio

PARA  
**DICROICA GU10**



**NEW!**



### TRACK LIGHT KIT 2

SUPERFICIE

ALUMINIO - TRACK LIGHT SUPERFICIE - NO INCLUYE BOMBILLA

LED TRACK LIGHT *Negro*  
LED TRACK LIGHT *Blanco*

Ref	PVPR
TRCK-079	28,23€
TRCK-080	28,23€



**NEW!**



### TRACK LIGHT KIT 3

SUPERFICIE

ALUMINIO - TRACK LIGHT SUPERFICIE - NO INCLUYE BOMBILLA

LED TRACK LIGHT *Negro*  
LED TRACK LIGHT *Blanco*

Ref	PVPR
TRCK-082	34,32€
TRCK-081	34,32€



**NEW!**



### TRACK LIGHT KIT 4

SUPERFICIE

ALUMINIO - TRACK LIGHT SUPERFICIE - NO INCLUYE BOMBILLA

LED TRACK LIGHT *Negro*  
LED TRACK LIGHT *Blanco*

Ref	PVPR
TRCK-097	47,67€
TRCK-098	47,67€



## Serie Track light - Aluminio

PARA  
**DICROICA GU10**



**DIFERENTES FORMAS DE COLOCACIÓN**



**ORIENTABLE 360°**

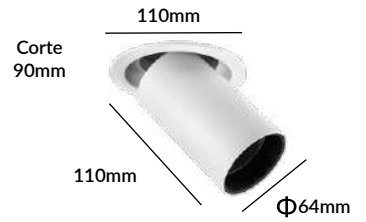

**DISEÑO MODERNO**

EMPOTRADO CON ARO

**SERIE ALUMINIO**

ALUMINIO - EMPOTRADO - NO INCLUYE LÁMPARA



	Ref	PVPR
TRACK LIGHT EMPOTRADO PARA Lámpara GU10	<i>Aluminio Blanco</i>	TRCK-099 41,16€
TRACK LIGHT EMPOTRADO PARA Lámpara GU10	<i>Aluminio Negro</i>	TRCK-100 41,16€



**DISEÑO MODERNO**

SUPERFICIE

**SERIE ALUMINIO**

ALUMINIO - SUPERFICIE - NO INCLUYE LÁMPARA

	Ref	PVPR
TRACK LIGHT PARA Lámpara GU10	<i>Aluminio Blanco</i>	TRCK-061 14,40 €
TRACK LIGHT PARA Lámpara GU10	<i>Aluminio Negro</i>	TRCK-062 14,40 €

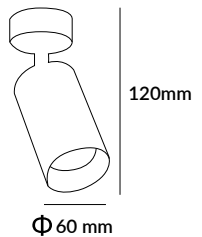

CARRIL

**SERIE ALUMINIO**

ALUMINIO - CONEXIÓN CARRIL TRIFÁSICO - NO INCLUYE LÁMPARA

	Ref	PVPR
TRACK LIGHT CARRIL TRIFÁSICO	<i>Dicroica GU10 - Blanco</i>	TRCK-029 31,32€
TRACK LIGHT CARRIL TRIFÁSICO	<i>Dicroica GU10 - Negro</i>	TRCK-030 31,32€



**NO VÁLIDO PARA DIC-066/077/067/084/065/085**

**Convierte tu track light de carril en un track light de superficie** Ø11mm

TRCK-041 - Blanco	TRCK-042 - Negro
9,90€	9,90€

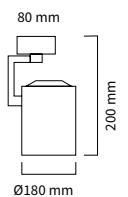

## Serie Track light - Aluminio

PARA  
**BOMBILLA QR111**  
Y PAR27

QR111

E27



SUPERFICIE



**ALUMINIO - SUPERFICIE - NO INCLUYE LÁMPARA**

TRACK LIGHT SUPERFICIE	QR111 - GU10 - Blanco	TRCK-026	39,00€
TRACK LIGHT SUPERFICIE	QR111 - GU10 - Negro	TRCK-025	39,00€

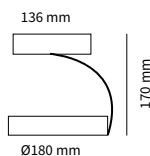

CARRIL



**ALUMINIO - CONEXIÓN CARRIL TRIFÁSICO - NO INCLUYE LÁMPARA**

TRACK LIGHT CARRIL TRIFÁSICO	QR111 - GU10 - Blanco	TRCK-028	44,76€
TRACK LIGHT CARRIL TRIFÁSICO	QR111 - GU10 - Negro	TRCK-027	44,76€

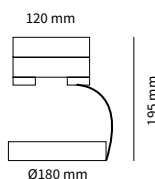

Accesorios

Superficie

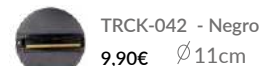
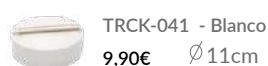

INTERCAMBIABLE  
MODULAR  
SYSTEM



SUPERFICIE

**ALUMINIO - SUPERFICIE - NO INCLUYE LÁMPARA**

		Ref	PVPR
TRACK LIGHT SUPERFICIE	PAR30 - E27 Blanco	TRCK-015	41,52€
TRACK LIGHT SUPERFICIE	PAR30 - E27 Negro	TRCK-016	41,52€

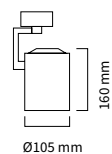

CARRIL

INTERCAMBIABLE  
MODULAR  
SYSTEM



**ALUMINIO - CONEXIÓN CARRIL TRIFÁSICO - NO INCLUYE LÁMPARA**

TRACK LIGHT CARRIL TRIFÁSICO	PAR30 - E27 Blanco	TRCK-001	49,47€
TRACK LIGHT CARRIL TRIFÁSICO	PAR30 - E27 Negro	TRCK-011	49,47€

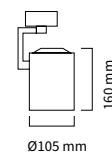

Accesorios

Superficie

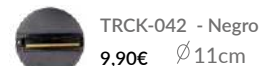

## Serie Track light - Aluminio

**LED INCLUIDO**

- DRIVER INCLUIDO EN EL CARRIL PARA UN DISEÑO MÁS ESTILIZADO.
- EVITA TRANSFERENCIA DE CALOR DEL DRIVER AL PROYECTOR.
- MATERIAL ALUMINIO.

**3 en 1 TRES TIPOS DE LUZ EN LA MISMA LUMINARIA**



Switch  
**3CCT**



LED DRIVER  
ALTA CALIDAD **LIFUD**

ALUMINIO - CONEXIÓN CARRIL TRIFÁSICO - LED INTEGRADO

	30w	K°	Ref	PVPR
LED TRACK LIGHT 3CCT	30w Blanco	3CCT	TRCK-105	59,85€
LED TRACK LIGHT 3CCT	30w Negro	3CCT	TRCK-106	59,85€



**SERIE ALUMINIO**

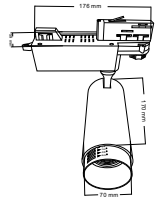



## SERIE ALUMINIO

5 en 1

CINCO TIPOS DE LUZ  
EN LA MISMA LUMINARIA



LED DRIVER  
ALTA CALIDAD



Switch  
5CCT



ALUMINIO - CONEXIÓN CARRIL TRIFÁSICO - LED INTEGRADO

	K°	Ref	PVPR
LED TRACK LIGHT 5CCT	30w Blanco	5CCT	TRCK-374 44,85 €
LED TRACK LIGHT 5CCT	30w Negro	5CCT	TRCK-375 44,85 €

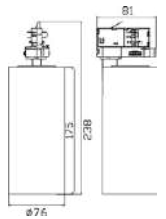

### Accesorios

#### Superficie

TRCK-041 - Blanco  
9,90€ Ø11cm

TRCK-042 - Negro  
9,90€ Ø11cm

TRCK-071 - Blanco  
5,76€ Ø9,9cm

TRCK-072 - Negro  
5,76€ Ø9,9cm

#### Empotrar

TRCK-073 - Blanco  
6,48€

TRCK-074 - Negro  
6,48€ Ø11cm

Corte  
Ø10,5cm

Diametro exterior  
Ø12cm

3 en 1

TRES TIPOS DE LUZ  
EN LA MISMA LUMINARIA



LED DRIVER  
ALTA CALIDAD

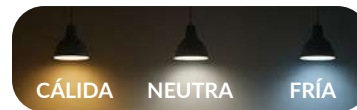

Switch  
3CCT



ALUMINIO - CONEXIÓN CARRIL TRIFÁSICO - LED INTEGRADO

	K°	Ref	PVPR
LED TRACK LIGHT 3CCT	30w Blanco	3CCT	TRCK-059 65,85€
LED TRACK LIGHT 3CCT	30w Negro	3CCT	TRCK-060 65,85€



USED  
bridgelux  
LED CHIPS



LENTE  
INTERCAMBIABLE

- ADAPTADOR LENTE 36°  
- ADAPTADOR LENTE 55°



PVPR

TRCK-063 ADAPTADOR LENTE 36° PARA TRACK LIGHT -059 AL -060

3,18€

TRCK-064 ADAPTADOR LENTE 55° PARA TRACK LIGHT -059 AL -060

4,65€

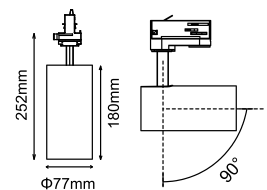

### Accesorios

#### Superficie

TRCK-041 - Blanco  
9,90€ Ø11cm

TRCK-042 - Negro  
9,90€ Ø11cm



**SERIE ALUMINIO**



**ALUMINIO - CONEXIÓN CARRIL TRIFÁSICO - LED INTEGRADO**

		K°	Ref	PVPR
TRACK LIGHT LED INTEGRADO	Blanco 3000Lm	4000K	TRCK-370	41,58 €
TRACK LIGHT LED INTEGRADO	Negro 3000Lm	4000K	TRCK-371	41,58 €
TRACK LIGHT LED INTEGRADO	Negro 3000Lm	3200K	TRCK-373	41,58 €

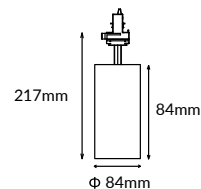

**Accesorios**

**Superficie**

TRCK-041 - Blanco  
9,90€ Ø 11cm

TRCK-042 - Negro  
9,90€ Ø 11cm

TRCK-071 - Blanco  
5,76€ Ø 9,9cm

TRCK-072 - Negro  
5,76€ Ø 9,9cm

**Empotrar**

TRCK-073 - Blanco  
6,48€

TRCK-074 - Negro  
6,48€ Ø 11cm

Corte  
Ø 10,5cm

Diametro exterior  
Ø 12cm



**NUEVO  
DISEÑO**



**High Efficiency**  
100Lm/w



**RENDIMIENTO  
CROMÁTICO  
ALTA CALIDAD**



LED DRIVER  
ALTA CALIDAD

**LED INTEGRADO - Aluminio - Carril TRIFÁSICO - Chip COB**

			K°	Ref	PVPR
TRACK LIGHT	LED INTEGRADO LUMILEDS	30W Blanco	4200K	TRCK-032	80,85€
TRACK LIGHT	LED INTEGRADO LUMILEDS	30W Blanco	5000K	TRCK-033	80,85€
TRACK LIGHT	LED INTEGRADO LUMILEDS	30W Negro	3200K	TRCK-034	80,85€
TRACK LIGHT	LED INTEGRADO LUMILEDS	30W Negro	4200K	TRCK-035	80,85€
TRACK LIGHT	LED INTEGRADO LUMILEDS	30W Negro	5000K	TRCK-036	80,85€

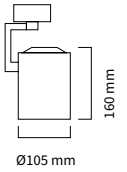

**ADAPTADOR LENTE 24°**



TRCK-055 ACCESORIO TRACK LIGHT -032 AL -036

5,61€

**CONVIERTE TU TRACK LIGHT  
EN REGULABLE**

Fácil sustitución



Led Driver track light dimmable triac  
TRCK-053 - Blanco  
89,25€



Led Driver track light dimmable triac  
TRCK-054 - Negro  
89,25€



# Track light DOMÓTICO

2 MODOS DE CONTROL WIFI + CONTROLADOR RF 2.4Ghz



CONTROLADOR REMOTO



COMPATIBLE CON APP **tuya**



3 en 1 TRES TIPOS DE LUZ EN LA MISMA LUMINARIA

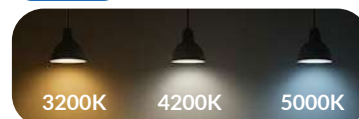

\* REGULABLE - CARRIL TRIFÁSICO



Used **OSRAM LED Chips**

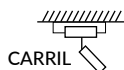

LED INTEGRADO

	K°	Ref	PVPR
TRACK LIGHT LED INTEGRADO 3CCT <b>WiFi 30W Blanco</b>	3CCT	TRCK-056	125,94€
TRACK LIGHT LED INTEGRADO 3CCT <b>WiFi 30W Negro</b>	3CCT	TRCK-057	125,94€

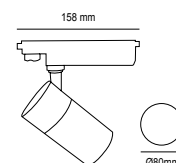

EL TRACK LIGHT DEBE ESTAR VINCULADO PARA PODER UTILIZAR EL MANDO A DISTANCIA.

\* Según la nueva normativa ERP ha habido un cambio en la medición de Lúmenes y vatios, pero sigue emitiendo la misma cantidad de luz. A medida que vayan entrando los nuevos modelos con ERP se irá actualizando en catálogo y cajas de color. Puede haber variación respecto la caja del producto (comprobar en ficha técnica), todos los datos en catálogo estan correctos salvo error tipográfico.



## Downlight de proyección **dimmable 3CCT**



**3 en 1** TRES TIPOS DE LUZ  
EN LA MISMA LUMINARIA

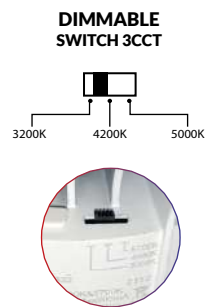
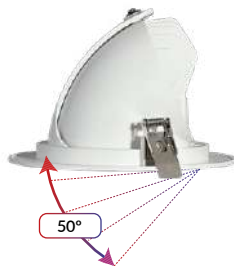

**\* BASCULANTE 50° - 3CCT - DIMMABLE TRIAC**

	K°	Ref	PVPR
DOWNLIGHT CIRCULAR DIMMABLE TRIAC 🌞 38W Blanco	3CCT	DOW-322	95,85€

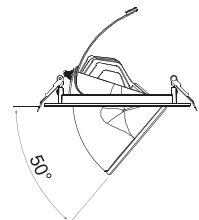
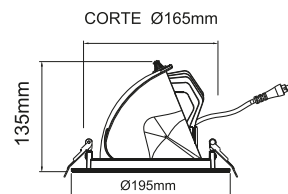



## Carril track light empotrado



	Ref	PVPR
TRACK RAIL EMPOTRAR 4 HILOS <i>2Metros Negro</i>	TRCK-083	82,32€
TRACK RAIL EMPOTRAR 4 HILOS <i>2Metros Blanco</i>	TRCK-084	82,32€
TRACK RAIL EMPOTRAR 4 HILOS <i>3Metros Negro</i>	TRCK-085	123,45€
TRACK RAIL EMPOTRAR 4 HILOS <i>3Metros Blanco</i>	TRCK-086	123,45€

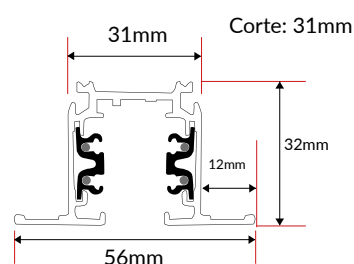

## Carril track light superficie



TRACK RAIL 1METRO <i>TRIFÁSICO 3 ENCENDIDOS Blanco</i>	TRCK-013	31,59€
TRACK RAIL 1METRO <i>TRIFÁSICO 3 ENCENDIDOS Negro</i>	TRCK-014	31,59€
TRACK RAIL 2METROS <i>TRIFÁSICO 3 ENCENDIDOS Blanco</i>	TRCK-002	63,18€
TRACK RAIL 2METROS <i>TRIFÁSICO 3 ENCENDIDOS Negro</i>	TRCK-012	63,18€

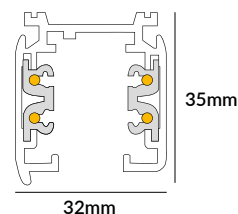

### ESQUEMA DE CONEXIÓN TRACK RAIL

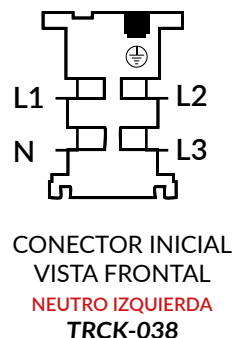
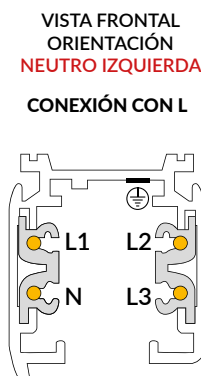
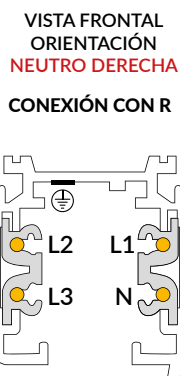
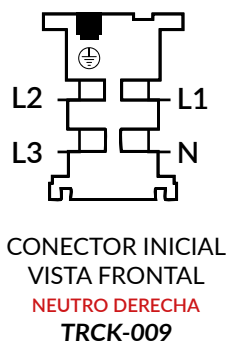

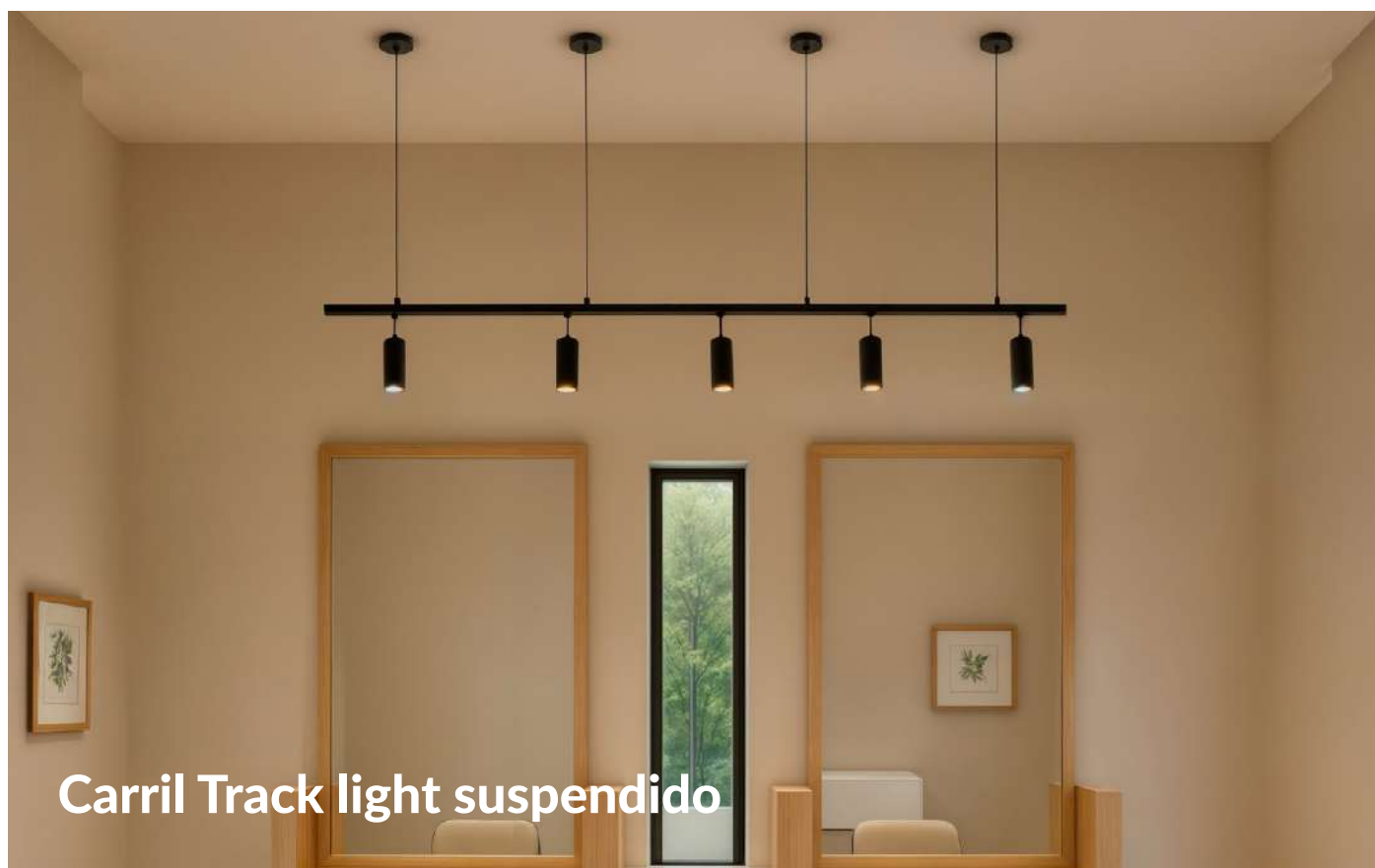

## Carril Track light suspendido



### REDONDO

			Ref	PVPR
ACCESORIOS SUSPENSIÓN 1 METRO	PARA RAIL BLANCO	Blanco	TRCK-008	17,28€
ACCESORIOS SUSPENSIÓN 1 METRO	PARA RAIL NEGRO	Negro	TRCK-022	17,28€



### REDONDO

ACCESORIOS SUSPENSIÓN 2 METROS	PARA RAIL BLANCO	Blanco	TRCK-069	17,88€
ACCESORIOS SUSPENSIÓN 2 METROS	PARA RAIL NEGRO	Negro	TRCK-070	17,88€



### CUADRADO

**NEW!**

ACCESORIOS SUSPENSIÓN 2 METROS	PARA RAIL BLANCO	Blanco	TRCK-067	7,35€
ACCESORIOS SUSPENSIÓN 2 METROS	PARA RAIL NEGRO	Negro	TRCK-068	7,35€



### CUADRADO

**NEW!**

ACCESORIOS SUSPENSIÓN 1 METRO	PARA RAIL BLANCO	Blanco	TRCK-065	6,75€
ACCESORIOS SUSPENSIÓN 1 METRO	PARA RAIL NEGRO	Negro	TRCK-066	6,75€



# ACCESORIOS TRACK LIGHT

\* CONSULTAR ESQUEMA  
INSTALACIÓN PAG 45



			Ref	PVPR
	TAPA FINAL PARA RAIL BLANCO	Blanco	TRCK-010	1,02€
	TAPA FINAL PARA RAIL NEGRO	Negro	TRCK-024	1,02€
	CONECTOR INICIAL PARA RAIL CON TAPA BLANCO <b>DERECHA</b>	Blanco	TRCK-009	7,35€
	CONECTOR INICIAL PARA RAIL CON TAPA NEGRO <b>DERECHA</b>	Negro	TRCK-023	7,35€
	CONECTOR INICIAL PARA RAIL CON TAPA BLANCO <b>IZQUIERDA</b>	Blanco	TRCK-038	7,35€
	CONECTOR INICIAL PARA RAIL CON TAPA NEGRO <b>IZQUIERDA</b>	Negro	TRCK-037	7,35€
	UNIÓN "I" PARA RAIL BLANCO	Blanco	TRCK-003	12,51€
	UNIÓN "I" PARA RAIL NEGRO	Negro	TRCK-017	12,51€
	UNION "I" <b>INTERIOR</b> PARA RAIL BLANCO	Blanco	TRCK-051	7,35€
	UNION "I" <b>INTERIOR</b> PARA RAIL NEGRO	Negro	TRCK-052	7,35€
	UNIÓN "L" PARA RAIL BLANCO <b>DERECHA</b>	Blanco	TRCK-006	12,81€
	UNIÓN "L" PARA RAIL NEGRO <b>DERECHA</b>	Negro	TRCK-020	12,81€
	UNION "L" PARA RAIL BLANCO <b>IZQUIERDA</b>	Blanco	TRCK-039	12,81€
	UNION "L" PARA RAIL NEGRO <b>IZQUIERDA</b>	Negro	TRCK-040	12,81€
	UNIÓN "T" PARA RAIL BLANCO <b>IZQUIERDA-ARRIBA</b>	Blanco	TRCK-004	19,44€
	UNIÓN "T" PARA RAIL NEGRO <b>IZQUIERDA-ARRIBA</b>	Negro	TRCK-018	19,44€
	UNIÓN "T" PARA RAIL BLANCO <b>IZQUIERDA - BAJO</b>	Blanco	TRCK-043	19,44€
	UNIÓN "T" PARA RAIL NEGRO <b>IZQUIERDA - BAJO</b>	Negro	TRCK-046	19,44€
	UNIÓN "T" PARA RAIL BLANCO <b>DERECHA - ARRIBA</b>	Blanco	TRCK-044	19,44€
	UNIÓN "T" PARA RAIL NEGRO <b>DERECHA - ARRIBA</b>	Negro	TRCK-047	19,44€
	UNIÓN "T" PARA RAIL BLANCO <b>DERECHA - BAJO</b>	Blanco	TRCK-045	19,44€
	UNIÓN "T" PARA RAIL NEGRO <b>DERECHA - BAJO</b>	Negro	TRCK-048	19,44€
	UNIÓN "X" PARA RAIL BLANCO <b>DERECHA</b>	Blanco	TRCK-007	24,24€
	UNIÓN "X" PARA RAIL NEGRO <b>DERECHA</b>	Negro	TRCK-021	24,24€
	UNIÓN "FLEX" PARA RAIL BLANCO	Blanco	TRCK-005	20,97€
	UNIÓN "FLEX" PARA RAIL NEGRO	Negro	TRCK-019	20,97€

\* Según la nueva normativa ERP ha habido un cambio en la medición de Lúmenes y vatios, pero sigue emitiendo la misma cantidad de luz.

A medida que vayan entrando los nuevos modelos con ERP se irá actualizando en catálogo y cajas de color.

Puede haber variación respecto la caja del producto (comprobar en ficha técnica), todos los datos en catálogo estan correctos salvo error tipográfico.

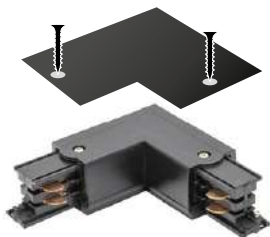

**NEW!**

## ACCESORIOS TRACK LIGHT EMPOTRADOS

### Haz tu instalación empotrada

Se puede adquirir la cubierta para hacer tu instalación empotrada.



**PARA TRCK-009/023 - TRCK-038/037**



		Ref	PVPR
CUBIERTA PARA CONECTOR INICIAL	Negro	TRCK-087	1,14€
CUBIERTA PARA CONECTOR INICIAL	Blanco	TRCK-088	1,14€



**PARA TRCK-003/017**



CUBIERTA PARA TRCK UNION "I"	Negro	TRCK-091	1,86€
CUBIERTA PARA TRCK UNION "I"	Blanco	TRCK-092	1,86€



**PARA TRCK-006/020 - 039/040**



CUBIERTA PARA TRCK UNION "L"	Negro	TRCK-089	1,86€
CUBIERTA PARA TRCK UNION "L"	Blanco	TRCK-090	1,86€



**PARA TRCK-004/018 - 043/046 - 044/047 - 045/048**



CUBIERTA PARA TRCK UNION "T"	Negro	TRCK-093	2,25€
CUBIERTA PARA TRCK UNION "T"	Blanco	TRCK-094	2,25€



**PARA TRCK-007/021**



CUBIERTA PARA TRCK UNION "X"	Negro	TRCK-095	2,61€
CUBIERTA PARA TRCK UNION "X"	Blanco	TRCK-096	2,61€



### CONECTOR INICIAL

TRCK 009/023    TRCK 038/037

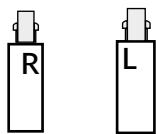

### UNIÓN "I"

TRCK-003/017    TRCK-051/052

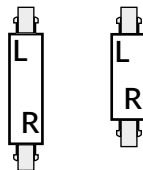

UNIÓN "T"  
TRCK-004/018

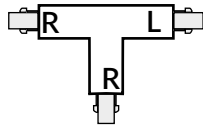

UNIÓN "T"  
TRCK-043/046

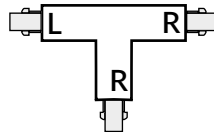

UNIÓN "X"  
TRCK-007/021

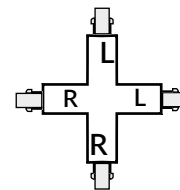

UNIÓN "T"  
TRCK-044/047

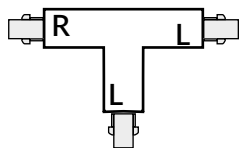

UNIÓN "T"  
TRCK-045/048

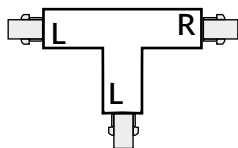

UNIÓN "L"  
TRCK-006/020

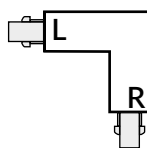

UNIÓN "L"  
TRCK-039/040

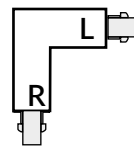

UNIÓN "FLEX"  
TRCK-005/019



### EJEMPLO INSTALACIÓN

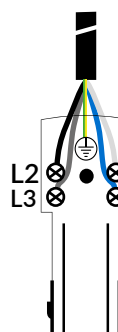
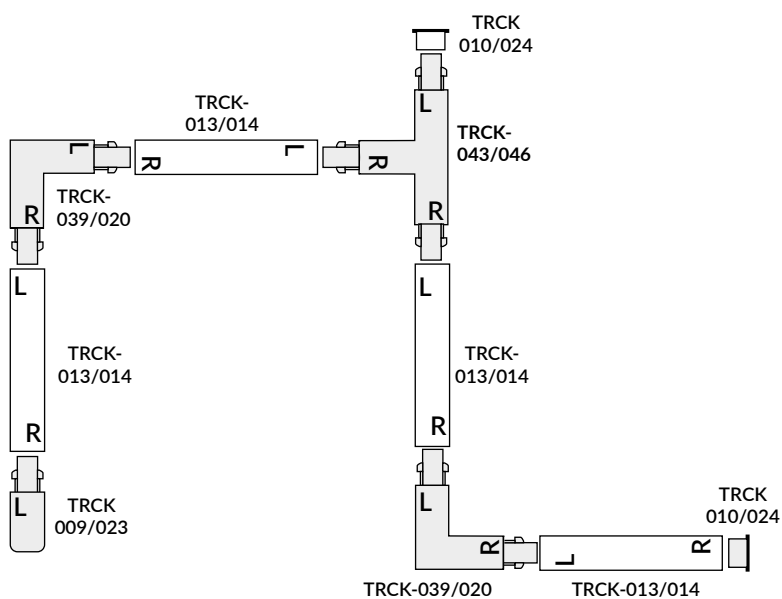

CONECTOR INICIAL  
VISTA SUPERIOR  
NEUTRO DERECHA  
TRCK-009

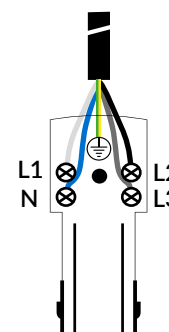

CONECTOR INICIAL  
VISTA SUPERIOR  
NEUTRO IZQUIERDA  
TRCK-038

**RESPECTAR LA ORIENTACIÓN DEL NEUTRO PARA LA CONEXIÓN. LAS CONEXIONES ENTRE ACCESORIOS Y TRACK RAIL SE REALIZARÁN SIEMPRE CONECTANDO "R" CON "L" O VICEVERSA.**

### ESQUEMA DE CONEXIÓN TRACK RAIL

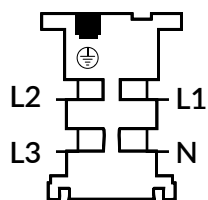

CONECTOR INICIAL  
VISTA FRONTAL  
NEUTRO DERECHA  
TRCK-009

VISTA FRONTAL  
ORIENTACIÓN  
NEUTRO DERECHA  
CONEXIÓN CON R

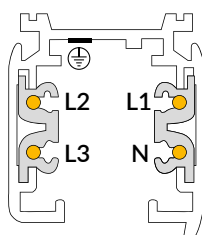

VISTA FRONTAL  
ORIENTACIÓN  
NEUTRO IZQUIERDA  
CONEXIÓN CON L

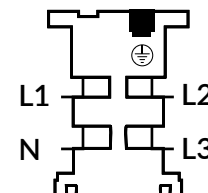
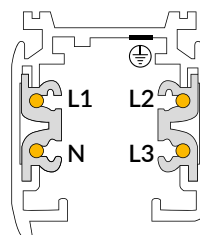

CONECTOR INICIAL  
VISTA FRONTAL  
NEUTRO IZQUIERDA  
TRCK-038

\* Según la nueva normativa ERP ha habido un cambio en la medición de Lúmenes y vatios, pero sigue emitiendo la misma cantidad de luz. A medida que vayan entrando los nuevos modelos con ERP se irá actualizando en catálogo y cajas de color. Puede haber variación respecto a la caja del producto (comprobar en ficha técnica), todos los datos en catálogo están correctos salvo error tipográfico.



*Serie* **Paneles**

## Serie Paneles empotrado

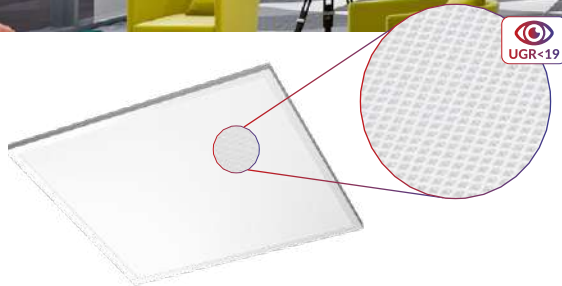

Especial oficinas,  
zonas de trabajo,..

La **pantalla LED UGR<19** se basa en controlar el deslumbramiento molesto también llamado deslumbramiento psicológico dando una **mejor calidad visual** al observador.

Gracias a su control de deslumbramiento es ideal para oficinas, zonas de trabajo, etc. ya que **reduce la fatiga visual**.

- Mejor calidad visual.
- Reduccion fatiga visual.
- Chip **LUMILEDS** de alta calidad.
- Fuente de alimentación **LIFUD** de alta calidad



PANEL LED EMPOTRADO UGR<19



PANEL ULTRA SLIM

NEW!

PANEL LED SLIM LUMILEDS 60 X 60CM **UGR<19 40W - ARO BLANCO 5000K** DOW-484

K° Ref PVPR

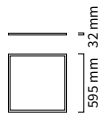

PANEL LED EMPOTRADO UGR<19



PANEL LED AT-40 LUMILEDS 60 X 60CM **UGR<19 40W - ARO BLANCO 4200K** DOW-256 47,40€  
 PANEL LED AT-40 LUMILEDS 60 X 60CM **UGR<19 40W - ARO BLANCO 5000K** DOW-257 47,40€

K° Ref PVPR

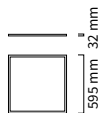

NEW PRICE!!

PANEL LED AT-40 LUMILEDS 30 X 120CM **UGR<19 40W - ARO BLANCO 4200K** DOW-260 50,34€  
 PANEL LED AT-40 LUMILEDS 30 X 120CM **UGR<19 40W - ARO BLANCO 5000K** DOW-261 50,34€

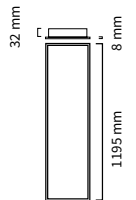

NEW PRICE!!

PANEL LED AT-40 LUMILEDS 60 X 120CM **UGR<19 80W - ARO BLANCO 4200K** DOW-258 111,12€  
 PANEL LED AT-40 LUMILEDS 60 X 120CM **UGR<19 80W - ARO BLANCO 5000K** DOW-259 111,12€

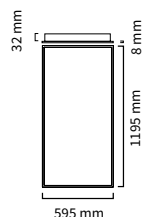

\* Según la nueva normativa ERP ha habido un cambio en la medición de Lúmenes y vatios, pero sigue emitiendo la misma cantidad de luz. A medida que vayan entrando los nuevos modelos con ERP se irá actualizando en catálogo y cajas de color. Puede haber variación respecto la caja del producto (comprobar en ficha técnica), todos los datos en catálogo estan correctos salvo error tipográfico.



### PANEL LED EMPOTRADO



PANEL ULTRA SLIM



	K°	Ref	PVPR
PANEL LED ELYOS 60 X 60CM	4200K	DOW-088	39,84€

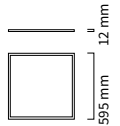

### PANEL LED SAMSUNG EMPOTRADO

NEW PRICE!!



	K°	Ref	PVPR
PANEL LED AT-40 LUMILEDS 60 X 60CM	4200K	DOW-196	40,35€
PANEL LED AT-40 LUMILEDS 60 X 60CM	5000K	DOW-197	40,35€

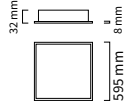

NEW PRICE!!



PANEL LED AT-40 LUMILEDS 30 X 120CM	4200K	DOW-254	48,00€
PANEL LED AT-40 LUMILEDS 30 X 120CM	5000K	DOW-255	48,00€

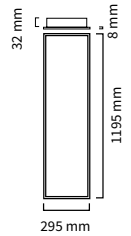

NEW PRICE!!



PANEL LED AT-40 LUMILEDS 60 X 120CM	4200K	DOW-252	99,00€
PANEL LED AT-40 LUMILEDS 60 X 120CM	5000K	DOW-253	99,00€

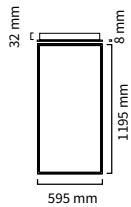

### PANEL LED EMPOTRADO 3CCT



3 en 1 TRES TIPOS DE LUZ EN LA MISMA LUMINARIA



Switch 3CCT

NEW PRICE!!



PANEL LED AT-40 60 X 60CM	4200K	DOW-282	43,50 €
---------------------------	-------	---------	---------

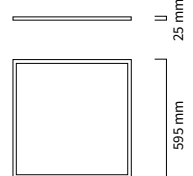

## Serie Paneles superficie

ESPECIAL  
COCINA

REGULACIÓN  
DIMMABLE  
TRIAC

DISEÑO  
MINIMALISTA

Panel LED  
ESPECIAL COCINA

**3**POTENCIAS  
20w/30w/40w

3 en 1 TRES TIPOS DE LUZ  
EN LA MISMA LUMINARIA



Switch  
3CCT



PANEL LED SUPERFICIE 100\*1200\*24mm 🌞 20 / 30 / 40w 3CCT ⚙️ DOW-319 153,69€

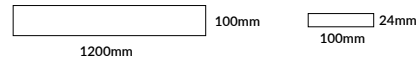

PANEL LED SUPERFICIE 3CCT

**Lifud**  
Led Driver

3 en 1 TRES TIPOS DE LUZ  
EN LA MISMA LUMINARIA

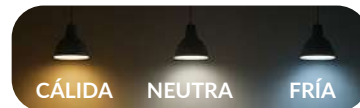

Switch  
3CCT



PANEL LED 60 X 60CM CUADRADO 40W - ARO BLANCO ⚙️ 3CCT ⚙️ DOW-320 80,85€

PANEL LED 30 X 120CM RECTANGULAR 40W - ARO BLANCO ⚙️ 3CCT ⚙️ DOW-321 90,75€

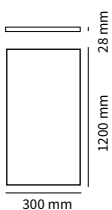
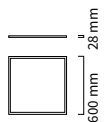

## Serie Panel Domótico



### Panel LED domótico



**3 en 1 TRES TIPOS DE LUZ**  
EN LA MISMA LUMINARIA

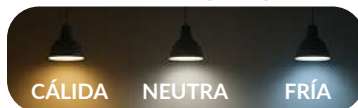

**2 MODOS DE CONTROL** WIFI + CONTROLADOR RF 2.4Ghz



Con Mando incluido

No incluye pilas en el precio

EMPOTRADO REGULABLE

COMPATIBLE CON APP **tuya**

PANEL LED 60 X 60CM WiFi 40W - ARO BLANCO 3CCT + RGB DOW-318 208,92€

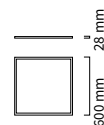



## ACCESORIOS PANEL

Ref ACLED - 003 Acc. Suspensión 1 Cable Panel 60x60 cm	Ref ACLED - 004 Acc. Suspensión 2 Cables Panel 60x60 cm	Ref ACLED - 005 Acc. Suspensión 4 Cables Panel 60x60 cm	Ref ACLED - 006 Acc. Garra Empotrar (4u) Panel 60x60 cm		
PVPR 11,88€	PVPR 13,62€	PVPR 13,62€	PVPR 9,06€		
Ref ACLED - 050 Perfil Empotrar Panel 30x120 cm	Ref ACLED - 051 Perfil Empotrar Panel 60x120 cm	Ref ACLED - 181 Perfil Superficie Panel 60x60 cm	Ref ACLED - 179 Perfil Superficie Panel 30x120 cm	Ref ACLED - 180 Perfil Superficie Panel 60x120 cm	
Montado	Montado	INCLUIDO DRIVER SLIM AXLED-017	INCLUIDO DRIVER SLIM AXLED-017	INCLUIDO DRIVER SLIM AXLED-017	
PVPR 41,79€	PVPR 59,40€	PVPR 50,58€	PVPR 56,22€	PVPR 66,72€	



## Accesorios de montaje por presión

- Montaje rápido y sencillo.

GRAN FACILIDAD  
DE MONTAJE

SISTEMA DE  
ANCLAJE POR  
PRESIÓN

No necesita  
tornillos

Ref ACLED - 393 Perfil Superficie Panel 60x60 cm Desmontado	Ref ACLED - 394 Perfil Superficie Panel 120x30 cm Desmontado	Ref ACLED - 395 Perfil Empotrado Panel 60x60 cm Desmontado	Ref ACLED - 396 Perfil Empotrado Panel 120x30 cm Desmontado	Ref ACLED - 398 Perfil Empotrado Panel 120x60 cm Desmontado
PVPR 36,18€	PVPR 41,79€	PVPR 35,94€	PVPR 41,79€	PVPR 51,36€



## Accesorio cielo para panel

Ref ACLED - 397  
Perfil Marco cielo  
Panel 60x60 cm  
PVPR 58,26€

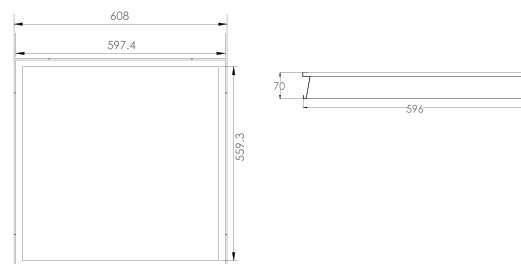

## LED DRIVER



Configurable V/mA - PWM - PARA PANEL

Ref

PVPR

LED DRIVER MEANWELL LCM-60 **40W - 6 OPCIONES DE CONFIGURACIÓN** AXLED-010 141,36€



LED DRIVER REGULABLE TRIAC **PARA PANEL 40-50W**

AXLED-012 47,46€



**LIFUD**  
Led Driver



LED DRIVER REGULABLE LIFUD 0-10V **PARA PANEL 40-50W**

AXLED-013 61,23€



LED DRIVER REGULABLE LIFUD 0-10V **PARA PANEL 40W**

AXLED-019 50,37€



LED DRIVER LIFUD DALI PUSH **PARA PANEL 40W**

AXLED-018 89,94€



LED DRIVER **PARA PANEL 40W**

AXLED-014 43,17€



LED DRIVER SLIM **PARA PANEL AT-40 40W**

AXLED-017 18,90€



Convierta y controle cualquier panel en **WIFI** y **WIFI regulable** con las pastillas 

COMPATIBLE CON APP **tuya**

Para más información consulte la **pág. 282**



Para interruptor simple, conmutado y cruce



PASTILLA INTERRUPTOR MINI LED **WIFI 300W LED**  Ref: CONTR-054 PVPR: 41,91€ **tuya**

➡ 230 V -

No apta para instalaciones conmutables



PASTILLA INTERRUPTOR MINI MULTIFUNCIÓN **WIFI 300W LED**  Ref: CONTR-082 PVPR: 29,85€ **tuya**

➡ 230 V -

Para DOBLE interruptor, interruptor partido y conmutado



PASTILLA DOBLE INTERRUPTOR LED **WIFI 2 X 150W**  Ref: CONTR-042 PVPR: 56,31€ **tuya**

➡ 230 V -

Disponible para varios pulsadores



Para varios pulsadores **REGULACIÓN TRIAC** 

PASTILLA **DIMMABLE TRIAC** WIFI 300W LED **WIFI 300W LED**  Ref: CONTR-063 PVPR: 60,66€ **tuya**

➡ 230 V -



PASTILLA TELERRUPTOR MINI WIFI **16A 230V - 300W LED**  Ref: CONTR-071 PVPR: 45,06€ **tuya**

➡ 230 V -

NEW!



**REGULACIÓN TRIAC**  DIMMABLE 0-100% SIN PARPADEO 

CONTROLADOR **DIMMABLE TRIAC** WIFI PULSADOR **WIFI 500W LED** Ref: CONTR-096 PVPR: 84,30€ **tuya**

➡ 230 V - · CONEXIÓN WIFI, 2,4Ghz, BLUETOOTH / CONTROL REMOTO 2,4Ghz

NEW!



PASTILLA **DIMMABLE TRIAC** WIFI RF UART HOLE **200W**  Ref: CONTR-104 PVPR: 58,50€ **tuya**

➡ 230 V -



Accesorio control remoto pulsador dimmable  
CONTR-105 (No incluido)

Ref: CONTR-105 PVPR: 14,43€

NEW!



PASTILLA ON/OFF WIFI RF UART HOLE **250W** Ref: CONTR-117 **tuya**

➡ 230 V -



Mando control remoto ON/OFF  
CONTR-118 (No incluido)

Ref: CONTR-118

NO DISPONE DE WIFI



PASTILLA PULSADOR CON EFECTO MEMORIA - FUNCIONA PARA VARIOS PULSADORES - NO DISPONE DE WIFI

PASTILLA **DIMMABLE TRIAC** POR PULSADOR  MÁX 200W  Ref: CONTR-022 PVPR: 52,62€



CONTR-036 CONTR-056

COMPATIBLE CON MANDO CONTR-036 Y CONTR-056

**REGULACIÓN TRIAC** 

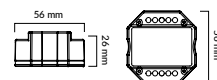

PASTILLA **DIMMABLE TRIAC** LED  SIN NEUTRO MÁX 250W Ref: CONTR-083 PVPR: 55,02 €

Este dimmer LED está diseñado para el control de lámparas LED regulables de hasta 250W. Con características de diseño compacto, brillo ajustable, potencia y memoria de ajuste de luz, es fácil de instalar y operar. 

- Tamaño compacto
- Sin ruido
- Regulación del borde de salida
- No necesita línea neutra
- Ideal para reequipamiento
- Luminosidad y velocidad de regulación regulables
- Memoria de potencia y luminosidad

**REGULACIÓN TRIAC** 

- REGULACIÓN TRIAC
- NO DISPONE DE WIFI
- NO APTA PARA INSTALACIONES CONMUTADAS
- SE PUEDE USAR CON PULSADORES EN PARALELO

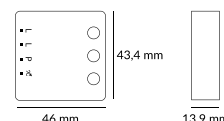

\* Según la nueva normativa ERP ha habido un cambio en la medición de Lúmenes y vatios, pero sigue emitiendo la misma cantidad de luz.

A medida que vayan entrando los nuevos modelos con ERP se irá actualizando en catálogo y cajas de color.

Puede haber variación respecto a la caja del producto (comprobar en ficha técnica), todos los datos en catálogo están correctos salvo error tipográfico.





*Serie Tubos y Pantallas estancas*

---

# Tubo led

## PROFESIONAL ESPECIAL GARAJE

SAMSUNG LED Inside

Serie PREMIUM

LED DRIVER  
ALTA CALIDAD



PROTECCIÓN  
sobretensión

+100.000  
ON/OFF



INCLUYE CEBADOR LED

TUBO LED PROSAMSUNG 9W - 600MM  
TUBO LED PROSAMSUNG 9W - 600MM

4200K TUB-038 8,49€  
5000K TUB-039 8,49€

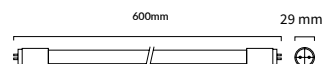

INCLUYE CEBADOR LED

TUBO LED PROSAMSUNG 18W - 1200MM  
TUBO LED PROSAMSUNG 18W - 1200MM

4200K TUB-040 10,26€  
5000K TUB-041 10,26€

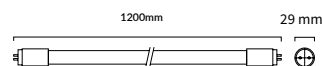

INCLUYE CEBADOR LED

TUBO LED PROSAMSUNG 22W - 1500MM  
TUBO LED PROSAMSUNG 22W - 1500MM

4200K TUB-042 13,56€  
5000K TUB-043 13,56€



# Tubo led



INCLUYE PORTALAMPARAS - CONEXIÓN OSCILANTE - IMÁN EN LA PARTE SUPERIOR

TUBO CIRCULAR	15W - 215 x 30mm - G10q	4200K	TUB-036	18,96€
TUBO CIRCULAR	15W - 215 x 30mm - G10q	5000K	TUB-028	18,96€

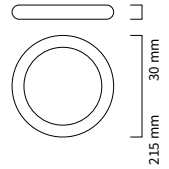

INCLUYE PORTALAMPARAS - CONEXIÓN OSCILANTE - IMÁN EN LA PARTE SUPERIOR

TUBO CIRCULAR	20W - 300 x 30mm - G10q	4200K	TUB-037	26,55€
TUBO CIRCULAR	20W - 300 x 30mm - G10q	5000K	TUB-029	20,25€

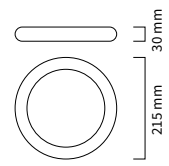

## Tubo led con sensor



BASE G13

TUBO LED RADAR SENSOR	18W	1200mm	160°	K°	Ref	PVPR
				5000K	TUB-044	15,84€

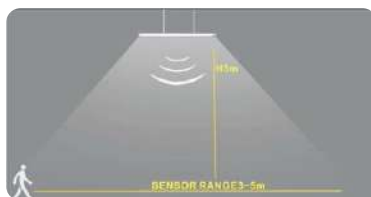
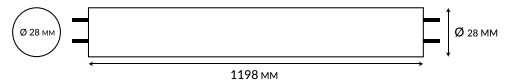

- Distancia detección hasta 5mts
- Altura 3mts
- Tiempo encendido 1min



BASE G13

TUBO LED RADAR SENSOR	18W	1200mm	160°	K°	Ref	Ref
				5000K	TUB-045	15,69€

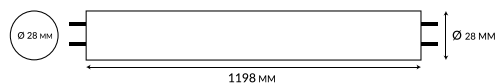

## Pantalla estanca tubo led

\* NO INCLUYEN TUBO DE LED



PANTALLA ESTANCA TUBO DE LED **ABS + PC** 1 x 600

Ref **PNT - 001** PVPR **16,50€**

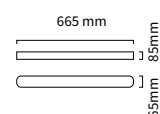

PANTALLA ESTANCA TUBO DE LED **ABS + PC** 2 x 600

Ref **PNT - 002** PVPR **19,74€**

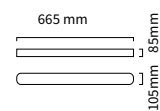

PANTALLA ESTANCA TUBO DE LED **ABS + PC** 1 x 1200

Ref **PNT - 003** PVPR **22,80€**

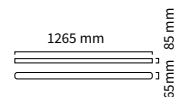

PANTALLA ESTANCA TUBO DE LED **ABS + PC** 2 x 1200

Ref **PNT - 004** PVPR **24,30€**

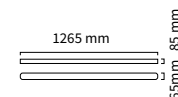

PANTALLA ESTANCA TUBO DE LED **ABS + PC** 1 x 1500

Ref **PNT - 005** PVPR **25,08€**

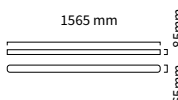

PANTALLA ESTANCA TUBO DE LED **ABS + PC** 2 x 1500

Ref **PNT - 006** PVPR **36,30€**

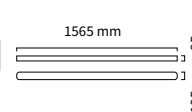

### Accesorios pantalla estanca



ACCESORIO GRAPA METAL DE PANTALLA ESTANCA

ACLED-090 0,60€



DIFUSOR PARA PANTALLA ESTANCA LED PARA REPOSICIÓN 1200mm

PNT-011 11,70€

Para PNT - 004 (2 x 1200mm)

DIFUSOR PARA PANTALLA ESTANCA LED PARA REPOSICIÓN 1500mm

PNT-010 11,70€

Para PNT - 006 (2 x 1500mm)

DIFUSOR PARA PANTALLA ESTANCA LED PARA REPOSICIÓN 600mm

PNT-015 11,70€

Para PNT - 001 (1 x 600mm)

DIFUSOR PARA PANTALLA ESTANCA LED PARA REPOSICIÓN 600mm

PNT-016 11,70€

Para PNT - 002 (2 x 600mm)



Conexión por un extremo

K°

Ref

PVPR

PANTALLA ESTANCA LED INTEGRADA

18w - 600mm

5000K

PNT-007

22,11€



Conexión por un extremo

PANTALLA ESTANCA LED INTEGRADA

35w - 1200mm

5000K

PNT-008

34,59€



Conexión por un extremo

PANTALLA ESTANCA LED INTEGRADA

45w - 1500mm

5000K

PNT-009

46,44€





Pantalla estanca Led 1200mm

High Efficiency  
120Lm/w

## MENOR CONSUMO MAYOR LUMINOSIDAD

EQUIVALE A UNA PANTALLA DE DOS TUBOS DE 1500mm CON MENOR CONSUMO

Used  
**SAMSUNG**  
LED Chips

**LIFUD**  
Led Driver



Used  
**SAMSUNG**  
LED Chips

**LIFUD**  
Led Driver

Conexión por un extremo - INCLUYE TIRA LED - Compatible con kit de emergencia EMR-026

PANTALLA ESTANCA CON TIRA DE LED CON DIFUSOR 36w - 1200mm 5000K PNT-012 59,10€

36W 4320 Lm 230v 8 IP65

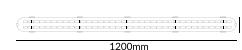

### ACCESORIOS

**DISPONIBLE PLACA PCB Y LED DRIVER DE SUSTITUCIÓN**

PLACA PCB PARA PANTALLA ESTANCA 36W 1200mm 5000K PNT-013 31,20€

LED DRIVER PARA PANTALLA ESTANCA 36W 1200mm 5000K PNT-014 25,20€

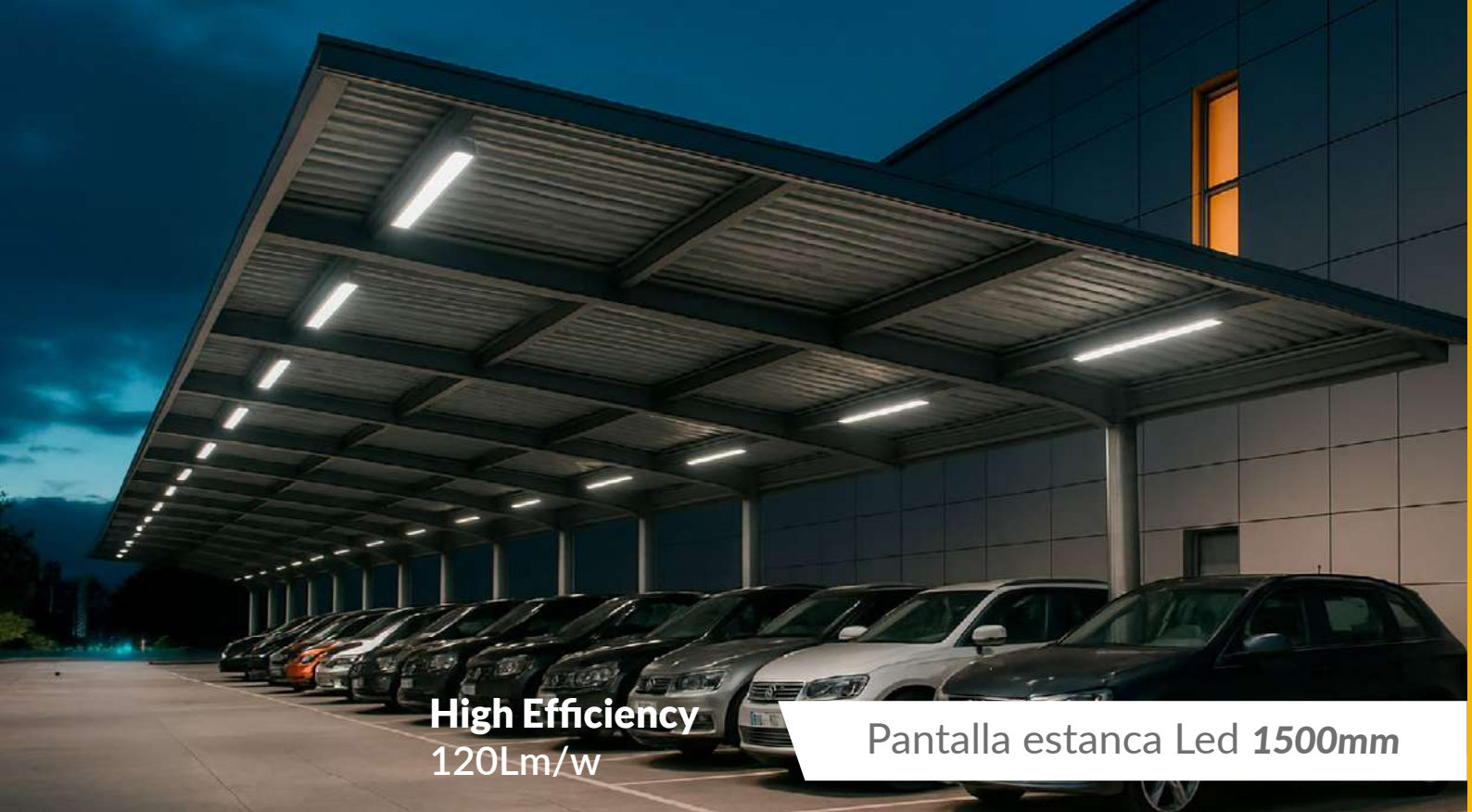

**High Efficiency**  
120Lm/w

**Pantalla estanca Led 1500mm**

## MENOR CONSUMO MAYOR LUMINOSIDAD



**NEW!**



Conexión por un extremo - INCLUYE TIRA LED - Compatible con kit de emergencia EMR-026

PANTALLA ESTANCA CON TIRA DE LED CON DIFUSOR 48w - 1500mm 5000K PNT-020

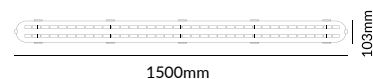

\* Según la nueva normativa ERP ha habido un cambio en la medición de Lúmenes y vatios, pero sigue emitiendo la misma cantidad de luz.  
A medida que vayan entrando los nuevos modelos con ERP se irá actualizando en catálogo y cajas de color.  
Puede haber variación respecto la caja del producto (comprobar en ficha técnica), todos los datos en catálogo están correctos salvo error tipográfico.



*Serie* **Regletas led**

---

## Serie Regletas - T5



**3 en 1 TRES TIPOS DE LUZ**  
EN LA MISMA LUMINARIA

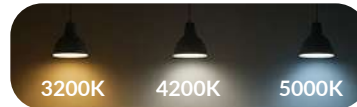

**Necesario incluir conector ACLED-469**

		K°	Ref	PVPR
REGLETA LED T5	5w - 400lm - 30cm	3CCT	RGL-364	9,06€
REGLETA LED T5	10w - 900lm - 60cm	3CCT	RGL-363	10,56€
REGLETA LED T5	15w - 1500lm - 90cm	3CCT	RGL-366	11,40€
REGLETA LED T5	18w - 1800lm - 120cm	3CCT	RGL-362	16,62€



CONECTOR CABLE PARA REGLETA T5 CON INTERRUPTOR SWITCH ON/OFF	ACLED-469	2,81€
--	-----------	-------

## Regleta led monocolor

**LINKABLE - Conexión entre regleta y regleta.**

**Interruptor integrado - Cable incluido de conexión - Incluye accesorio de empalme para conexión entre regleta y regleta.**



		K°	Ref	PVPR
REGLETA LED T5	4w - 300lm - 30cm	3200K	RGL-001	9,09€
REGLETA LED T5	8w - 650lm - 60cm	3200K	RGL-004	10,23€
REGLETA LED T5	12w - 900lm - 90cm	3200K	RGL-007	13,89€
REGLETA LED T5	12w - 900lm - 90cm	4200K	RGL-008	13,89€
REGLETA LED T5	12w - 900lm - 90cm	5000K	RGL-009	13,89€
REGLETA LED T5	16w - 1250lm - 120cm	3200K	RGL-010	14,73€
REGLETA LED T5	16w - 1250lm - 120cm	4200K	RGL-011	14,73€

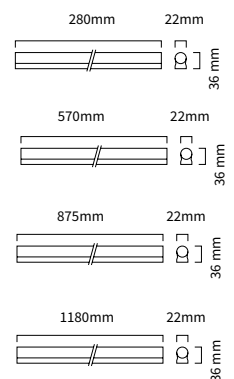

CONECTOR CABLE PARA REGLETA T5	15cm	ACLED-078	2,88€
--------------------------------	------	-----------	-------



\* Según la nueva normativa ERP ha habido un cambio en la medición de Lúmenes y vatios, pero sigue emitiendo la misma cantidad de luz.

A medida que vayan entrando los nuevos modelos con ERP se irá actualizando en catálogo y cajas de color.

Puede haber variación respecto a la caja del producto (comprobar en ficha técnica), todos los datos en catálogo están correctos salvo error tipográfico.

# Regleta led superficie



REGLETA LED CURVA SUPERFICIE **15w - 2800lm - 60cm** 4200K RGL-027 11,10€

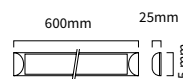

REGLETA LED PLANA SUPERFICIE **18w - 1200lm - 60cm** 4200K RGL-013 21,33€

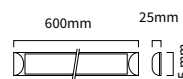

REGLETA LED PLANA SUPERFICIE **18w - 1200lm - 60cm** 5000K RGL-014 21,33€

REGLETA LED PLANA SUPERFICIE **36w - 2200lm - 120cm** 4200K RGL-015 33,87€

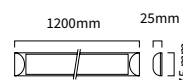

REGLETA LED PLANA SUPERFICIE **45w - 3000lm - 150cm** 4200K RGL-017 45,03€





## Regleta led plana superficie 3CCT

**3 en 1** TRES TIPOS DE LUZ  
EN LA MISMA LUMINARIA



			Ref	PVPR	
REGLETA LED PLANA SUPERFICIE	120cm	3CCT	RGL-029	35,28€	1200mm 
REGLETA LED PLANA SUPERFICIE	150cm	3CCT	RGL-030	39,96€	1500mm 

\* Según la nueva normativa ERP ha habido un cambio en la medición de Lúmenes y vatios, pero sigue emitiendo la misma cantidad de luz. A medida que vayan entrando los nuevos modelos con ERP se irá actualizando en catálogo y cajas de color. Puede haber variación respecto la caja del producto (comprobar en ficha técnica), todos los datos en catálogo están correctos salvo error tipográfico.

# Apliques armario

**ESPECIAL ARMARIO**

## FÁCIL INSTALACIÓN - IMAN ADHESIVO EN LA PARTE TRASERA



Pilas no incluidas - Detección 5 metros - Tiempo encendido 20seg

REGLETA LED 24cm CON SENSOR IR	4 PILAS AAA 1,5v	K°	Ref	PVPR
REGLETA LED 24cm CON SENSOR IR	4 PILAS AAA 1,5v	3200K	RGL-019	11,94€
REGLETA LED 24cm CON SENSOR IR	4 PILAS AAA 1,5v	5000K	RGL-020	11,94€



Cable USB incluido



Cable USB incluido - Detección 3metros - Tiempo encendido 20seg - Batería recargable 1 x 5V 450mAh

REGLETA LED 30cm CON SENSOR IR	BATERÍA USB	3200K	RGL-022	25,26€
REGLETA LED 30cm CON SENSOR IR	BATERÍA USB	5000K	RGL-021	25,26€



Sujeción magnética

Cable USB incluido - Detección 3 - 6metros - Tiempo de encendido 25seg - Batería recargable 1 x 3.7V 700mAh

APLIQUE LED ARMARIO SENSOR DE MOVIMIENTO	BATERÍA USB	3200K	APQ-015	8,88€
APLIQUE LED ARMARIO SENSOR DE MOVIMIENTO	BATERÍA USB	6500K	APQ-016	8,88€



**ESPECIAL COCINA**

## Serie Regletas - Especial cocina

**2 MODOS DE TRABAJO**  
ON/OFF/AUTO

**3 INTENSIDADES**  
DE LUZ 50%/75%/100%

**3 en 1 TRES TIPOS DE LUZ**  
EN LA MISMA LUMINARIA

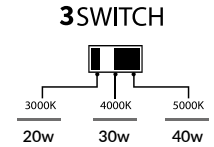

**NEW!**

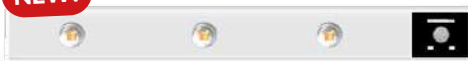

**BATERÍA USB**

**REGLETA CON SENSOR DE MOVIMIENTO 40CM**

Ref

PVPR

RGL-365

35,07€



OFF/ON/AUTO

OFF - Apagado  
On - Modo continuo de luz  
Auto - Modo percepción movimiento

SENSOR PIR

INDICADOR DE CARGA

INTERRUPTOR SELECTOR 3CCT

INTENSIDAD DE LUZ



**GRAN AUTONOMÍA**  
Batería - 2000mAh



**NEW!**

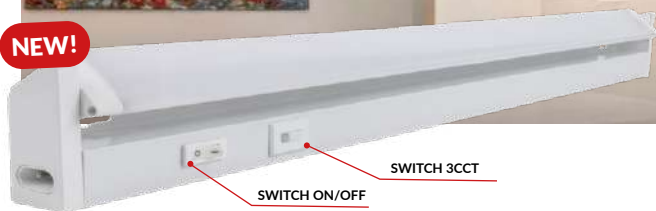

**REGLETA LED**  
ORIENTABLE 120°



**3 en 1 TRES TIPOS DE LUZ**  
EN LA MISMA LUMINARIA



Ref

					Ref
REGLETA LED ORIENTABLE 120°	4W	30CM SUPERFICIE	3CCT		RGL-031
REGLETA LED ORIENTABLE 120°	8W	55CM SUPERFICIE	3CCT		RGL-032
REGLETA LED ORIENTABLE 120°	12W	84CM SUPERFICIE	3CCT		RGL-033

Incluido en la caja:

- Luminaria
- Cable conexión 230v
- Cable conexión entre regletas
- Accesorios de instalación

\* Según la nueva normativa ERP ha habido un cambio en la medición de Lúmenes y vatios, pero sigue emitiendo la misma cantidad de luz.

A medida que vayan entrando los nuevos modelos con ERP se irá actualizando en catálogo y cajas de color.

Puede haber variación respecto a la caja del producto (comprobar en ficha técnica), todos los datos en catálogo están correctos salvo error tipográfico.



*Serie Tiras de led*

---



## GRAN VARIEDAD DE TIRAS LED

Descubre nuestras últimas incorporaciones de tiras de led.

**NEW!**



### Fácil, rápido y discreto

Instala tu tira de led sin necesidad de perfil protector.

Tiras de led acabado **OPAL**.

\*Tira led opal - Pág-160



### La tira de led más estrecha del mercado

Tiras de led **SLIM** especial muebles.

\*Tira led slim - Pág-162



### Se ajusta a la medida exacta de tu instalación

Tiras de led **FREE CUT**, corta por donde quieras.

\*Free cut - Pág-166



### Creatividad sin límites

Gran variedad y combinaciones en la misma tira de led **DIGITAL**

\*Tira led digital - Pág-168

## Adhesivo de Gran calidad **3M VHB**

Algunas de nuestras tiras led cuentan con el adhesivo más fuerte del mercado.

### MÁXIMA CALIDAD | ULTRA FIJACIÓN



**3M | VHB**  
ADHESIVO VHB  
EXTRA FUERTE



ADHESIVO VHB DE ALTAS PRESTACIONES



EXCELENTE RESISTENCIA AMBIENTAL Y DURABILIDAD PARA EL SECTOR PROFESIONAL ELÉCTRICO



MAYOR DURABILIDAD Y ELASTICIDAD QUE EL ADHESIVO CONVENCIONAL



ADHESIVO RESISTENTE AL CALOR Y LA HUMEDAD



FÁCIL Y RÁPIDO DE INSTALAR

## PIDE TU EXPOSITOR Y AÑADE LA BOBINA QUE QUIERAS

### Expositor **ATMOSS** de tiras led

Expositor de bobinas de tiras LED diseñado para puntos de venta. Permite tener las tiras organizadas y visibles, facilitando el corte a medida para los clientes. Estructura robusta, ideal para mostradores o zonas de autoservicio. Mejora la presentación y agiliza la venta en almacenes eléctricos.

\* Capacidad hasta 8 bobinas de tira de led.

\* Consultar condiciones



Ideal para trabajos con poca luz.  
Luz led incorporada

## Soldador digital con batería

• Facilidad para soldar tiras led en situaciones difíciles

Soldador digital con punta fina, ideal para soldar tiras de led en situaciones difíciles

Rango de temperatura

°C 260°C - 430°C

NEW!



SOLDADOR DIGITAL CON BATERIA USB-C 3.7V 260°C-430°C

Ref

PVPR

SLD-001

29,04€

Carga por USB TIPO C



- CABLE INCLUIDO  
- BATERÍA LI-TIO  
3.7V - 1000mAh



GRAN AUTONOMÍA  
Batería - 1000mAh



Batería 1000mAh



Portatil



LCD Digital



Temperatura °C



Luz de trabajo



Rápido calentamiento  
Rango de temperatura  
260°C - 430°C

ACCESORIOS incluidos



Estuche de almacenamiento



Resina de alta calidad para limpiar la punta



Soporte para el soldador



Cable de carga USB Tipo-C

## Rodillo de goma para tira de LED

NEW!



Nuestra herramienta de rodillo de goma para tira LED es óptimo para profesionales que trabajan con montajes de tiras LED.

Certifica un acabado profesional y optimiza la estética general de los proyectos de iluminación interior y exterior.

Dos tamaños de rodillo de tamaño de 47mm y 41mm

Ref

PVPR

RODILLO GOMA 6mm / 10mm CON MANGO PARA TIRA LED

ACLED-300

7,44€

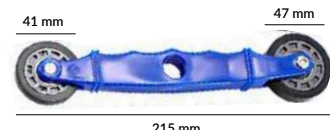

215 mm

# • Caja al corte

SOLO DISPONIBLE EN LAS SIGUIENTES REFERENCIAS

**NEW!**

**ATMOSS**  
LIGHTING

TIRA DE LED AL CORTE



## Tira Led **COB** 230V

230V

TRANSPARENTE

ACCESORIOS PÁG-156

IP65

Potencia	IP	Lúmenes	leds/metro	Metros	K°	Ref	PVPR
10w/m	IP65	1300Lm	560	25 Metros	2700K	TLED-158	297€
10w/m	IP65	1300Lm	560	25 Metros	3200K	TLED-159	297€
10w/m	IP65	1300Lm	560	25 Metros	4200K	TLED-160	297€
10w/m	IP65	1300Lm	560	25 Metros	5000K	TLED-161	297€



25m

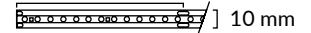

10 w/m

230 V

1300 Lm/m

1

120°

IP 65

25 M

+

CHIP COB

REAL COLOR INDEX CRI 90

Nuevo Adhesivo posterior 3M VHB EXTRA FUERTE

3M

## Tira Led **COB** 230V

230V

OPAL

ACCESORIOS PÁG-161

IP65

Potencia	IP	Lúmenes	leds/metro	Metros	K°	Ref	PVPR
10w/m	IP65	1300Lm	560	25 Metros	2700K	TLED-152	297€
10w/m	IP65	1300Lm	560	25 Metros	3200K	TLED-153	297€
10w/m	IP65	1300Lm	560	25 Metros	4200K	TLED-154	297€
10w/m	IP65	1300Lm	560	25 Metros	5000K	TLED-155	297€



25m

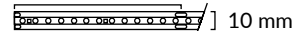

10 w/m

230 V

1300 Lm/m

1

120°

IP 65

25 M

+

CHIP COB

Nuevo Adhesivo posterior 3M VHB EXTRA FUERTE

3M

**NEW PRICE!!**

## Tira Led **COB** 24V

24V

TRANSPARENTE

ACCESORIOS PÁG-163

IP20

Potencia	IP	Lúmenes	leds/metro	Metros	K°	Ref	PVPR
10w/m	IP20	1000Lm	320	50 Metros	3200K	TLED-093	228,60€
10w/m	IP20	1000Lm	320	50 Metros	4200K	TLED-094	228,60€



50mm

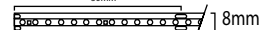

10 w/m

1000 Lm/m

24V

1

120°

50 M

+

CHIP COB

\* Según la nueva normativa ERP ha habido un cambio en la medición de Lúmenes y vatios, pero sigue emitiendo la misma cantidad de luz.

A medida que vayan entrando los nuevos modelos con ERP se irá actualizando en catálogo y cajas de color.

Puede haber variación respecto a la caja del producto (comprobar en ficha técnica), todos los datos en catálogo están correctos salvo error tipográfico.

# Serie Tiras Led 230v

# Tira Led COB 230V

CONEXIÓN DIRECTA

IMPRESINDIBLE PARA SU INSTALACIÓN PERFIL DISIPADOR.  
TIRADAS MÁXIMAS DE 25 METROS

CONTROLADORES PÁG-158 WIFI

### CAJA CUSTOMIZADA AL CORTE

**NEW!**

IP65

Potencia	IP	Lúmenes	leds/metro	Metros	K°	Ref	PVPR
10w/m	IP65	1300Lm	560	25 Metros	2700K	TLED-158	297€
10w/m	IP65	1300Lm	560	25 Metros	3200K	TLED-159	297€
10w/m	IP65	1300Lm	560	25 Metros	4200K	TLED-160	297€
10w/m	IP65	1300Lm	560	25 Metros	5000K	TLED-161	297€

Nuevo Adhesivo posterior  
**3M VHB EXTRA FUERTE**



25m



### ACCESORIOS

Enchufe conexión  
Ref **IP65 ACLED - 237**

Conector TIRA - TIRA  
Ref **IP65 ACLED - 239**

Conector ESQUINA  
Ref **IP65 ACLED - 240**

Tapa FINAL  
Ref **IP65 ACLED - 241**

Conector TIRA - CABLE  
Ref **1,5m P65 ACLED - 238**

**NEW!**

IP65

Potencia	IP	Lúmenes	leds/metro	Metros	K°	Ref	PVPR
12w/m	IP65	1300Lm	480	50 Metros	3200K	TLED-127	447€
12w/m	IP65	1300Lm	480	50 Metros	4200K	TLED-128	447€
12w/m	IP65	1300Lm	480	50 Metros	5000K	TLED-129	447€

Nuevo Adhesivo posterior  
**3M VHB EXTRA FUERTE**  
- No es necesario rectificador



50m

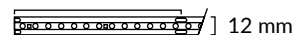

### ACCESORIOS

ACLED - 497  
Enchufe conexión  
12mm - P65  
PVPR 2,61€

ACLED - 498  
Cable 1 metro  
sin enchufe  
12mm - P65  
PVPR 0,36€

ACLED - 496  
Conector TIRA - TIRA  
recto  
12mm - P65  
PVPR 1,86€

ACLED - 494  
Conector TIRA-TIRA  
esquina  
12mm - P65  
PVPR 7,08€

ACLED - 495  
Tapa final  
12mm - P65  
PVPR 8,94€

Potencia	IP	Lúmenes	leds/metro	Metros	K°	Ref	PVPR
12w/m	IP65	1300Lm	480	50 Metros	3200K	TLED-114	357,60€
12w/m	IP65	1300Lm	480	50 Metros	4200K	TLED-115	357,60€
12w/m	IP65	1300Lm	480	50 Metros	5000K	TLED-116	357,60€

En una caja contiene 2 UDS DE 25METROS



50m

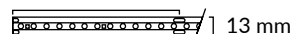

### ACCESORIOS

Necesario conexión  
con ACLED-201  
ACLED - 201  
Enchufe conexión  
230V  
12mm - P65  
PVPR 7,80€

ACLED-202  
Tapa final  
230V COB  
PVPR 0,48€

ACLED-203  
Conector  
TIRA-TIRA  
PVPR 4,50€

ACLED-204  
Grapa PVC  
PVPR 0,48€

# Tira Led SMD 230V

CONEXIÓN DIRECTA

IMPRESINDIBLE PARA SU INSTALACIÓN PERFIL DISIPADOR.  
TIRADAS MÁXIMAS DE 25 METROS

CONTROLADORES PÁG-158 WIFI

**NEW!**



Potencia	IP	Lúmenes	leds/metro	Metros	K°	Ref	PVPR
12w/m	IP65	1500Lm	120	50 Metros	2700K	TLED-169	
12w/m	IP65	1500Lm	120	50 Metros	3000K	TLED-119	525€
12w/m	IP65	1500Lm	120	50 Metros	4000K	TLED-120	525€
12w/m	IP65	1500Lm	120	50 Metros	5000K	TLED-121	525€

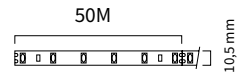

12 w/m 230 V 1500 Lm/m 1 120° - + IP 65 50 M

**High Efficiency**  
120LEDS/ METRO

**ALTA**  
LUMINOSIDAD

Nuevo Adhesivo posterior  
**3M VHB EXTRA FUERTE**



## ACCESORIOS



ACLED - 232 PVPR  
Enchufe conexión  
6,21€



ACLED - 222 PVPR  
Conector medio 2PIN  
TIRA - TIRA  
1,56€



ACLED - 220 PVPR  
Grapa PVC  
0,24€



ACLED - 221 PVPR  
Tapa final  
0,24€

\* ENCHUFE DE CONEXIÓN INCLUIDO

**NEW PRICE!!**

## DIMMABLE HASTA 40%



Potencia	IP	Lúmenes	leds/metro	Metros	K°	Ref	PVPR
14w/m	IP65	1300Lm	120	50 Metros	3200K	TLED-070	495€
14w/m	IP65	1300Lm	120	50 Metros	4200K	TLED-071	495€
14w/m	IP65	1300Lm	120	50 Metros	5000K	TLED-072	495€

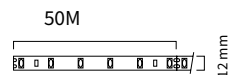

14 w/m 230 V 1300 Lm/m 1 120° - + IP 65 50 M

Nuevo Adhesivo posterior  
**3M VHB EXTRA FUERTE**



## ACCESORIOS



ACLED - 154 PVPR  
Enchufe conexión  
Tira LED 2835 230V  
7,08€



ACLED - 158 PVPR  
Tapa final  
Tira LED 2835 230V  
0,54€



ACLED - 159 PVPR  
Conector cable  
TIRA-TIRA  
Tira LED 2835 230V  
4,20€

\* ENCHUFE DE CONEXIÓN INCLUIDO

Used **SAMSUNG**  
LED Chips **1500**  
Lm

**NEW PRICE!!**



Potencia	IP	Lúmenes	leds/metro	Metros	K°	Ref	PVPR
15w/m	IP65	1500Lm	120	50 Metros	3200K	TLED-457	495€
15w/m	IP65	1500Lm	120	50 Metros	4200K	TLED-458	495€
15w/m	IP65	1500Lm	120	50 Metros	5000K	TLED-459	495€

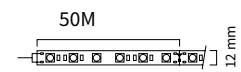

15 W/m 230 V 1500 Lm/m 1 120° - + IP 65 50 M

**High Efficiency**  
120LEDS/ METRO

**ALTA**  
LUMINOSIDAD

## ACCESORIOS



ACLED - 460 PVPR  
Enchufe conexión  
Tira LED 230V Samsung  
7,08€



ACLED - 461 PVPR  
Conector rápido TIRA - TIRA  
Samsung - 230V Monocolor  
7,08€

\* Según la nueva normativa ERP ha habido un cambio en la medición de Lúmenes y vatios, pero sigue emitiendo la misma cantidad de luz.  
A medida que vayan entrando los nuevos modelos con ERP se irá actualizando en catálogo y cajas de color.  
Puede haber variación respecto a la caja del producto (comprobar en ficha técnica), todos los datos en catálogo están correctos salvo error tipográfico.

REQUIERE ACLED-067 *Enchufe conexión Tira 041-065-042*  
NO REGULABLE

**NEW PRICE!!**

Potencia	IP	Lúmenes	leds/metro	Metros	K°	Ref	PVPR
8w/m	IP67	603Lm	120	<b>50 Metros</b>	3200K	TLED-041	265,68€
8w/m	IP67	603Lm	120	<b>50 Metros</b>	4200K	TLED-065	265,68€
8w/m	IP67	603Lm	120	<b>50 Metros</b>	6500K	TLED-042	265,68€

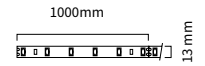

CONEXIÓN DIRECTA

8 w/m 230 V 603 Lm/m 1 120° IP 67 50 M

ACCESORIOS

	<b>ACLED - 070</b> Conector recto Tira <b>MONOCOLOR</b>	<b>PVPR</b> 1,56€		<b>ACLED - 077</b> Conector 2 pin cable unión Tira Monocolor	<b>PVPR</b> 4,20€		<b>ACLED - 073</b> Grapa PVC Tira <b>MONOCOLOR</b>	<b>PVPR</b> 0,24€		<b>ACLED - 067</b> Enchufe conexión Tira <b>MONOCOLOR</b>	<b>PVPR</b> 6,21€
	<b>CONTR - 033</b> Controlador LED tira <b>MONOCOLOR</b> <i>Máx. 80 mts.</i>	<b>PVPR</b> 66,12€		<b>ACLED - 071</b> Tapa final Tira <b>MONOCOLOR</b>	<b>PVPR</b> 0,24€		<b>CONTR - 034</b> Controlador LED tira IR 230V. <b>MONOCOLOR</b> <i>Máx. 50 mts.</i>	<b>PVPR</b> 33,24€		<b>ACLED - 068</b> Conector 2 Pin Tira <b>MONOCOLOR</b>	<b>PVPR</b> 0,66€

Tira Led SMD 230V RGB

**NEW PRICE!!**

Potencia	IP	Lúmenes	leds/metro	Metros	K°	Ref	PVPR
14w/m	IP67	724Lm	120	<b>50 Metros</b>	RGB	TLED-043	482,94€

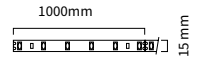

CONEXIÓN DIRECTA

ACCESORIOS

	<b>ACLED - 072</b> Tapa final para Tira RGB	<b>PVPR</b> 0,39€		<b>ACLED - 074</b> Grapa PVC Tira RGB	<b>PVPR</b> 0,39€		<b>CONTR - 032</b> Controlador para Tira RGB <b>CONEXIÓN POR PRESIÓN</b>	<b>PVPR</b> 28,74€
	<b>ACLED - 075</b> Conector 4 PIN Tira RGB	<b>PVPR</b> 2,73€		<b>ACLED - 069</b> Conector cable Tira RGB	<b>PVPR</b> 4,20€		<b>CONTR - 072</b> Controlador para Tira RGB <b>CONEXIÓN POR PINCHO</b>	<b>PVPR</b> 28,74€

Tira led 230V dimmable con las pastillas:

2,4GHz  
**CONTR-022**  
Pastilla reguladora TRIAC  
Función PUSH - 360W - Efecto memoria  
52,62€

Compatible con mando  
**CONTR-036** **CONTR-098**

WiFi 2,4GHz **tuya**  
**CONTR-063**  
Pastilla reguladora TRIAC WIFI  
Funciona para varios pulsadores - Máx 300w  
60,66€

WiFi 2,4GHz Bluetooth **tuya**  
**CONTR-096**  
Pastilla reguladora TRIAC - 2,4GHz  
Función PUSH - Máx 500w  
84,30€

WiFi 2,4GHz **tuya**  
**CONTR-104**  
Pastilla reguladora TRIAC - 2,4GHz  
Máx 150w - Accesorio no incluido CONTR-105  
58,50€

**CONTR-105**  
Receptor RF + Mando pulsador para CONTR-104  
ON/OFF - Regulación  
14,43€

Transporte no incluido. Para más información y descarga de fichas técnicas - [www.atmoss.es](http://www.atmoss.es) -

TODOS LOS PRECIOS SON EN PVPR Y ESTÁN SUJETOS A MODIFICACIONES. LOS PRECIOS ESTÁN CORRECTOS SALVO ERROR TIPOGRÁFICO, EN ÚLTIMA INSTANCIA COMPROBAR EN TARIFA DE PRECIOS - COMPROBAR MEDIDAS CON EL ARTICULO EN FÍSICO YA QUE PUEDE HABER ERROR TIPOGRÁFICO

# Tira Led Neon Flex 230V

**NEW!**



Potencia	IP	Lúmenes	leds/metro	Metros	K°	Ref	PVPR
10w/m	IP65	800Lm	240	25 Metros	Golden 2100K	TLED-125	178,38€
10w/m	IP65	800Lm	240	25 Metros	3200K	TLED-122	178,32€
10w/m	IP65	800Lm	240	25 Metros	4200K	TLED-123	178,32€
10w/m	IP65	800Lm	240	25 Metros	6500K	TLED-124	178,32€



2500 mm

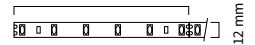

Enchufe conexión directa incluido

## ACCESORIOS



ACLED - 487  
Enchufe conexión tira led neon flex

PVPR  
3,48€



ACLED - 488  
Tapa final para tira led neon flex

PVPR  
0,39€



ACLED - 400  
Grapa PLS transparente

PVPR  
0,39€

TLED-125 - Golden



TLED-122 -3200K



TLED-123 -4200K



TLED-124 -6500K



## ACCESORIOS - PAG-168



Potencia	IP	Lúmenes	leds/metro	Metros	K°	Ref	PVPR
8w/m	IP67	800Lm	120	50 Metros	Multicolor	TLED-069	332,25€
8w/m	IP67	800Lm	120	50 Metros	RGB	TLED-086	594,33€



2500 mm

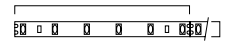

TIRA RGB NEON FLEX COMPATIBLE CON CONTROLADOR CONTR-072

## ACCESORIOS



Ref ACLED - 148  
Enchufe conexión tira led neón Multicolor 230v PARA TLED-069

PVPR 11,94€



Ref ACLED - 175  
Enchufe conexión tira led neón RGB 230v PARA TLED-069

PVPR 10,38€



Ref CONTR-072  
Controlador para Tira led RGB 230v PARA TLED-086 CONEXIÓN POR PINCHO

PVPR 28,74€



Ref ACLED - 072  
Tapa final para Tira RGB

PVPR 0,39€

\* Según la nueva normativa ERP ha habido un cambio en la medición de Lúmenes y vatios, pero sigue emitiendo la misma cantidad de luz.

A medida que vayan entrando los nuevos modelos con ERP se irá actualizando en catálogo y cajas de color.

Puede haber variación respecto a la caja del producto (comprobar en ficha técnica), todos los datos en catálogo están correctos salvo error tipográfico.

# Tira Led COB OPAL

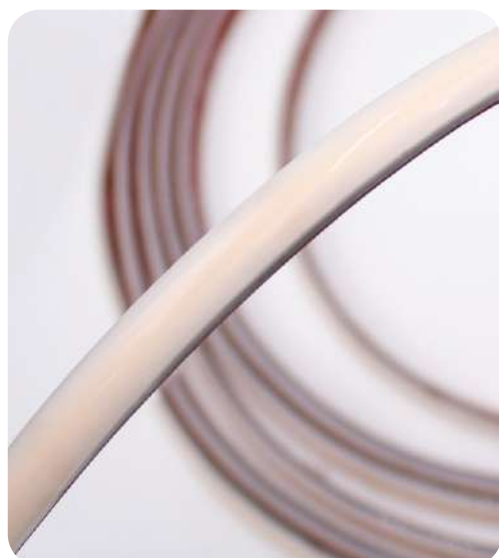
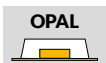

## VENTAJAS

### Fácil y rápida instalación:

No necesitas herramientas especiales ni estructuras adicionales. Solo retiras el adhesivo y pegas la tira donde quieras.

### Menor coste:

Ahorras dinero al no tener que comprar perfiles de aluminio, difusores u otros accesorios.

### Más flexibilidad en el diseño:

Las tiras pueden doblarse y adaptarse fácilmente a superficies curvas, esquinas o formas irregulares.

### Menor grosor y más discreción:

Al no tener perfil, el conjunto ocupa menos espacio y se integra mejor en lugares estrechos o visibles.



Protección IP65





# Tira Led COB OPAL



## Tira Led COB OPAL 230V



Protección silicona  
BLANCO MATE

**NEW!**



Potencia	IP	Lúmenes	leds/metro	Metros	K°	Ref	PVPR
10w/m	IP65	1300Lm	560	25 Metros	2700K	TLED-152	297€
10w/m	IP65	1300Lm	560	25 Metros	3200K	TLED-153	297€
10w/m	IP65	1300Lm	560	25 Metros	4200K	TLED-154	297€
10w/m	IP65	1300Lm	560	25 Metros	5000K	TLED-155	297€

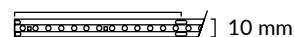

Nuevo Adhesivo posterior  
3M VHB EXTRA FUERTE



### ACCESORIOS

Enchufe conexión

Ref **IP65 ACLED - 237**



Conector TIRA - TIRA

Ref **IP65 ACLED - 239**



Conector ESQUINA

Ref **IP65 ACLED - 240**



Tapa FINAL

Ref **IP65 ACLED - 241**



Conector TIRA - CABLE

Ref **1,5m P65 ACLED - 238**



### CONTROLADORES PÁG-158

CONTR-022, CONTR-063, CONTR-096, CONTR-104

## Tira Led COB OPAL 24V



Protección silicona  
BLANCO MATE

**NEW!**



Potencia	IP	Lúmenes	leds/metro	Metros	K°	Ref	PVPR
12w/m	IP65	1140Lm	560	5 Metros	2700K	TLED-140	48,48€
12w/m	IP65	1140Lm	560	5 Metros	3200K	TLED-141	48,48€
12w/m	IP65	1140Lm	560	5 Metros	4200K	TLED-142	48,48€
12w/m	IP65	1140Lm	560	5 Metros	5000K	TLED-143	48,48€



5m

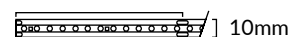

**NEW PRICE!!**



12w/m	IP65	1140Lm	560	50 Metros	2700K	TLED-136	470,37€
12w/m	IP65	1140Lm	560	50 Metros	3200K	TLED-137	470,37€
12w/m	IP65	1140Lm	560	50 Metros	4200K	TLED-138	470,37€
12w/m	IP65	1140Lm	560	50 Metros	5000K	TLED-139	470,37€

50m

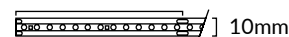

Nuevo Adhesivo posterior  
3M VHB EXTRA FUERTE



### ACCESORIOS

Conector TIRA-CABLE

Ref **ACLED - 502**



PVPR

4,86€

Conector ESQUINA

Ref **IP65 ACLED - 504**



PVPR

2,61€

Conector TIRA-TIRA

Ref **ACLED - 503**



PVPR

1,86€

Conector TAPA FINAL

Ref **IP65 ACLED - 505**



PVPR

0,36€

### CONTROLADORES PARA TIRAS LED MONOCOLOR 24V

WIFI (CONTR-060, CONTR-097, CONTR-106) PÁG-175

NO WIFI (CONTR-029, CONTR-073, CONTR-038, CONTR-021, CONTR-012, CONTR-011, CONTR-066, CONTR-024, CONTR-058, CONTR-079, ALM-032) PÁG-176, PÁG-178

\* Según la nueva normativa ERP ha habido un cambio en la medición de Lúmenes y vatios, pero sigue emitiendo la misma cantidad de luz.

A medida que vayan entrando los nuevos modelos con ERP se irá actualizando en catálogo y cajas de color.

Puede haber variación respecto a la caja del producto (comprobar en ficha técnica), todos los datos en catálogo están correctos salvo error tipográfico.

# Tira Led COB 24V

IP20 | IP65 | 5M | 50M

ACCESORIOS Y CONTROLADORES PÁG - 164

**NEW PRICE!!**



	Potencia	IP	Lúmenes	leds/metro	Metros		K°	Ref	PVPR
IP20	10w/m	IP20	900Lm	320	5 Metros		3200K	TLED-087	23,85€
	10w/m	IP20	900Lm	320	5 Metros	↓	4200K	TLED-088	23,85€
	10w/m	IP20	900Lm	320	5 Metros		5000K	TLED-089	23,85€
IP65	10w/m	IP65	900Lm	320	5 Metros		3200K	TLED-090	35,25€
	10w/m	IP65	900Lm	320	5 Metros	↓	4200K	TLED-091	35,25€
	10w/m	IP65	900Lm	320	5 Metros		5000K	TLED-092	35,25€
IP20	10w/m	IP20	900Lm	320	50 Metros		3200K	TLED-093	228,60€
	10w/m	IP20	900Lm	320	50 Metros	↓	4200K	TLED-094	228,60€
	10w/m	IP20	900Lm	320	50 Metros		5000K	TLED-095	228,60€

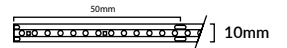
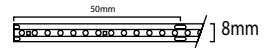

<b>NEW!</b>	10w/m	IP20	900Lm	320	5 Metros		2700K	TLED-203	
	10w/m	IP65	900Lm	320	5 Metros		2700K	TLED-204	



Nuevo Adhesivo posterior 3M VHB EXTRA FUERTE



	Potencia	IP	Lúmenes	leds/metro	Metros		K°	Ref	PVPR
IP20	12w/m	IP20	1000Lm	480	5 Metros		3200K	TLED-073	37,98€
	12w/m	IP20	1000Lm	480	5 Metros	↓	4200K	TLED-074	37,98€
	12w/m	IP20	1000Lm	480	5 Metros		5000K	TLED-075	37,98€
IP65	12w/m	IP65	1000Lm	480	5 Metros		3200K	TLED-076	49,95€
	12w/m	IP65	1000Lm	480	5 Metros	↓	4200K	TLED-077	49,95€
	12w/m	IP65	1000Lm	480	5 Metros		5000K	TLED-078	49,95€
IP20	12w/m	IP20	1000Lm	480	50 Metros		3200K	TLED-079	359,70€
	12w/m	IP20	1000Lm	480	50 Metros	↓	4200K	TLED-080	359,70€
	12w/m	IP20	1000Lm	480	50 Metros		5000K	TLED-081	359,70€

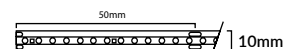
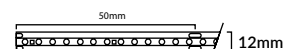

<b>NEW!</b>	12w/m	IP65	1140Lm	480	5 Metros	↓	2700K	TLED-130	46,62€
-------------	-------	------	--------	-----	----------	---	-------	----------	--------



**NEW PRICE!!**

5m

IP65	12w/m	IP65	1140Lm	480	50 Metros		3200K	TLED-131	507€
	12w/m	IP65	1140Lm	480	50 Metros	↓	4200K	TLED-132	507€
	12w/m	IP65	1140Lm	480	50 Metros		5000K	TLED-133	507€



Nuevo Adhesivo posterior 3M VHB EXTRA FUERTE



# Tira led COB High Efficiency

**ALTA**  
LUMINOSIDAD

**NEW PRICE!!**

	Potencia	IP	Lúmenes	leds/metro	Metros	K°	Ref	PVPR
IP20	15w/m	IP20	1500Lm	480	5 Metros	2500K	TLED-099	42,78€
	15w/m	IP20	1500Lm	480	5 Metros	3200K	TLED-096	42,78€
	15w/m	IP20	1500Lm	480	5 Metros	4200K	TLED-097	42,78€
	15w/m	IP20	1500Lm	480	5 Metros	5000K	TLED-098	42,78€
IP65	15w/m	IP65	1500Lm	480	5 Metros	3200K	TLED-100	56,01€
	15w/m	IP65	1500Lm	480	5 Metros	4200K	TLED-101	56,01€
	15w/m	IP65	1500Lm	480	5 Metros	5000K	TLED-102	56,01€
IP20	15w/m	IP20	1500Lm	480	50 Metros	3200K	TLED-103	427,95€
	15w/m	IP20	1500Lm	480	50 Metros	4200K	TLED-104	427,95€
	15w/m	IP20	1500Lm	480	50 Metros	5000K	TLED-105	427,95€

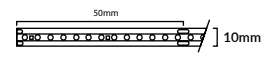
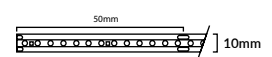

15 w/m   1500 Lm/m   24V   1   120°

## ACCESORIOS

IP20	ACLED - 227 Conector fijo tornillo Tira-Cable IP20 10mm	PVPR 2,22€	ACLED - 226 Conector fijo tornillo Tira-Tira 2P 10mm IP20	PVPR 2,22€	ACLED - 228 Conector fijo tornillo Tira-Tira "T&L" 2P 10mm	PVPR 3,12€	ACLED - 229 Conector invisible Tira-Tira "L" 2P 10mm IP20	PVPR 1,62€	ACLED - 223 Conector rápido COB Tira-Tira IP20 c/cable 2P 10mm	PVPR 5,22€	ACLED - 162 Conector rápido tira COB Tira - Tira 10mm 5 uds	PVPR 6,84€
IP20	ACLED - 208 Conector rápido LED TIRA-CABLE 2P 8MM IP20 * CON CABLE	PVPR 2,70€	ACLED - 207 Conector rápido LED COB TIRA-TIRA 2-PIN 8MM IP20 24v	PVPR 1,98€	ACLED - 210 Conector rápido LED TIRA-CABLE 2P 10MM IP20 * CON CABLE	PVPR 2,70€	ACLED - 209 Conector rápido LED COB TIRA-TIRA 2-PIN 10MM IP20 24v	PVPR 1,98€				
IP68	ACLED - 211 Conector rápido LED COB TIRA-TIRA 2-PIN 8MM IP68 24V	PVPR 4,38€	ACLED - 213 Conector rápido LED COB TIRA-TIRA 2-PIN 10MM IP68 24V	PVPR 4,62€	ACLED - 212 Conector rápido LED COB TIRA-CABLE Con cable 2-PIN 8MM IP68 24V * CON CABLE	PVPR 4,98€	ACLED - 214 Conector rápido LED COB TIRA-CABLE Con cable 2-PIN 10MM IP68 24V	PVPR 5,22€				

## CONTROLADORES PARA TIRAS LED MONOCOLOR 24V

- WIFI (CONTR-060, CONTR-097, CONTR-106) PÁG-175
- NO WIFI (CONTR-029, CONTR-073, CONTR-038, CONTR-021, CONTR-012, CONTR-011, CONTR-066, CONTR-024, CONTR-058, CONTR-079, ALM-032) PÁG-176, PÁG-178

\* Según la nueva normativa ERP ha habido un cambio en la medición de Lúmenes y vatios, pero sigue emitiendo la misma cantidad de luz. A medida que vayan entrando los nuevos modelos con ERP se irá actualizando en catálogo y cajas de color. Puede haber variación respecto a la caja del producto (comprobar en ficha técnica), todos los datos en catálogo están correctos salvo error tipográfico.

# Tira Led COB 3CCT



**3 en 1 TRES TIPOS DE LUZ**  
EN LA MISMA LUMINARIA

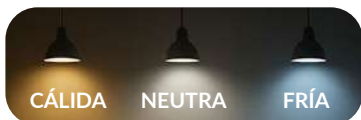

**NEW!**

	Potencia	IP	Lúmenes	leds/metro	Metros	K°	Ref	PVPR
IP20	15w/m	IP20	1500Lm	576	5 Metros	3 CCT	TLED-106	88,29€
IP65	15w/m	IP65	1500Lm	576	5 Metros	3 CCT	TLED-107	88,29€

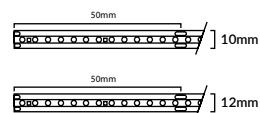

**CONTROLADORES  
PARA TIRAS LED  
3CCT 24V**

**WIFI - PÁG-175**  
CONTR-060, CONTR-097,  
CONTR-108, CONTR-109,  
CONTR-061, CONTR-062

**NO WIFI PÁG-176, PÁG-178**  
CONTR-029, CONTR-027,  
CONTR-073, CONTR-074,  
CONTR-021, CONTR-012,  
CONTR-011, CONTR-066,  
CONTR-024, CONTR-058,  
CONTR-079

## ACCESORIOS

Ref	ACLED - 516 CONECTOR TIRA-TIRA COB 3P IP20	ACLED - 517 CONECTOR TIRA-CABLE 3P IP20	ACLED - 518 CONECTOR TIRA-TIRA CABLE 3P IP20
PVPR	0,36€	1,04€	1,38€

# Serie Tiras Led COB ESPECIAL MUEBLE

ULTRA SLIM MUEBLES



ULTRA SLIM MUEBLES

Potencia	IP	Lúmenes	leds/metro	Metros	K°	Ref	PVPR
5w/m	IP20	480Lm	480	5 Metros	3200K	TLED-134	55,92€

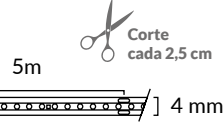

IP20

5 w/m 480 Lm/m 24V 1 120° IP 20 5 M

Nuevo Adhesivo posterior 3M VHB EXTRA FUERTE

CONTROLADORES PARA TIRAS LED MONOCOLOR 24V

WIFI - PÁG-175  
CONTR-060,  
CONTR-097,  
CONTR-106

NO WIFI PÁG-176, PÁG-178  
CONTR-029, CONTR-073,  
CONTR-038, CONTR-021,  
CONTR-012, CONTR-011,  
CONTR-066, CONTR-024,  
CONTR-058, CONTR-079

## 3 en 1 TRES TIPOS DE LUZ EN LA MISMA LUMINARIA

CÁLIDA NEUTRA FRÍA



ULTRA SLIM MUEBLES

Potencia	IP	Lúmenes	leds/metro	Metros	K°	Ref
9w/m	IP20	900Lm	600	5 Metros	3CCT	TLED-200

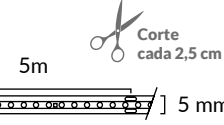

IP20

9 w/m 900 Lm/m 24V 1 120° IP 20 5 M

CONTROLADORES PARA TIRAS LED 3CCT 24V

WIFI - PÁG-175  
CONTR-060, CONTR-097,  
CONTR-108, CONTR-109,  
CONTR-061, CONTR-062

NO WIFI PÁG-176, PÁG-178  
CONTR-029, CONTR-027,  
CONTR-073, CONTR-074,  
CONTR-021, CONTR-012,  
CONTR-011, CONTR-066,  
CONTR-024, CONTR-058,  
CONTR-079

### ACCESORIOS PARA TLED-134-200

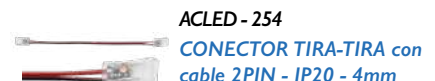
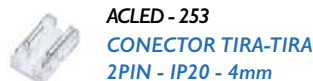
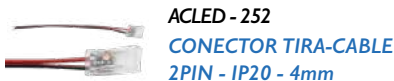

ULTRA SLIM 3mm MUEBLES

Potencia	IP	Lúmenes	leds/metro	Metros	K°	Ref
7w/m	IP20	700Lm	400	5 Metros	2700K	TLED-201
7w/m	IP20	700Lm	400	5 Metros	3000K	TLED-202

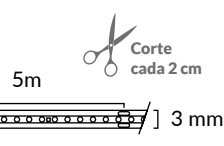

IP20

7 w/m 700 Lm/m 24V 1 120° IP 20 5 M

CONTROLADORES PARA TIRAS LED MONOCOLOR 24V

WIFI - PÁG-175  
CONTR-060,  
CONTR-097,  
CONTR-106

NO WIFI PÁG-176, PÁG-178  
CONTR-029, CONTR-073,  
CONTR-038, CONTR-021,  
CONTR-012, CONTR-011,  
CONTR-066, CONTR-024,  
CONTR-058, CONTR-079

### ACCESORIOS

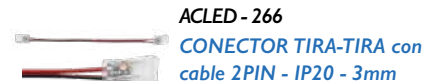
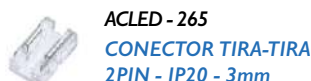
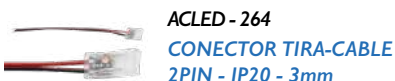

\* Según la nueva normativa ERP ha habido un cambio en la medición de Lúmenes y vatios, pero sigue emitiendo la misma cantidad de luz.

A medida que vayan entrando los nuevos modelos con ERP se irá actualizando en catálogo y cajas de color.



Puede haber variación respecto a la caja del producto (comprobar en ficha técnica), todos los datos en catálogo están correctos salvo error tipográfico.



## Se ajusta a la medida exacta de tu instalación

**NEW!**

 **FREE CUT**

	Potencia	IP	Lúmenes	leds/metro	Metros	K°	Ref	PVPR
	12w/m	IP20	1150 Lm	576	5 Metros	2700K	TLED-174	
	12w/m	IP20	1150 Lm	576	5 Metros	3200K	TLED-175	
	12w/m	IP20	1150 Lm	576	5 Metros	4000K	TLED-176	
	12w/m	IP20	1150 Lm	576	5 Metros	5000K	TLED-177	
	12w/m	IP20	1150 Lm	576	25 Metros	2700K	TLED-144	277,08€
	12w/m	IP20	1150 Lm	576	25 Metros	3200K	TLED-145	277,08€
	12w/m	IP20	1150 Lm	576	25 Metros	4200K	TLED-146	277,08€
	12w/m	IP20	1150 Lm	576	25 Metros	5000K	TLED-147	277,08€
	12w/m	IP65	1150 Lm	576	25 Metros	2700K	TLED-148	346,32€
	12w/m	IP65	1150 Lm	576	25 Metros	3200K	TLED-149	346,32€
	12w/m	IP65	1150 Lm	576	25 Metros	4200K	TLED-150	346,32€
	12w/m	IP65	1150 Lm	576	25 Metros	5000K	TLED-151	346,32€



Nuevo Adhesivo posterior  
**3M VHB EXTRA FUERTE**



### ACCESORIOS IP20

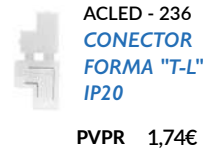

### ACCESORIOS IP65

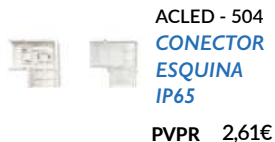
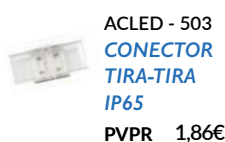
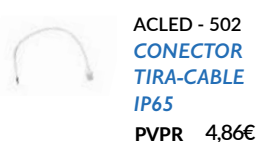

### CONTROLADORES PARA TIRAS LED MONOCOLOR 24V

WIFI  (CONTR-060, CONTR-097, CONTR-106) PÁG-175

NO WIFI (CONTR-029, CONTR-073, CONTR-038, CONTR-021, CONTR-012, CONTR-011, CONTR-066, CONTR-024, CONTR-058, CONTR-079, ALM-032) PÁG-176, PÁG-178



# Tira Led COB 24V RGB

	Potencia	IP	Lúmenes	leds/metro	Metros	K°	Ref	PVPR
IP20	14w/m	IP20	1200 Lm	576	5 Metros	RGB	TLED-117	64,14€
IP67	14w/m	IP67	1200 Lm	576	5 Metros	RGB	TLED-118	80,19€
IP20	21w/m	IP20	1600 Lm	672	25 Metros	RGB	TLED-156	311,70€
IP65	21w/m	IP65	1600 Lm	672	25 Metros	RGB	TLED-157	389,58€

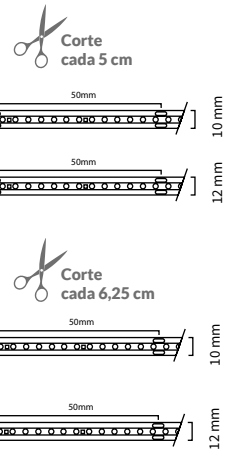

14 w/m 1200 Lm/m 24V 1 120°

Nuevo Adhesivo posterior 3M VHB EXTRA FUERTE

21 w/m 1600 Lm/m 24V 1 120°

Nuevo Adhesivo posterior 3M VHB EXTRA FUERTE

CONTROLADORES PARA TIRAS LED RGB 24V WIFI - PÁG-175 CONTR-050, CONTR-061, CONTR-062, CONTR-080

NO WIFI PÁG-176, PÁG-178 CONTR-027, CONTR-074, CONTR-039, CONTR-020, CONTR-078, CONTR-037, CONTR-049, CONTR-014, CONTR-013, CONTR-018 CONTR-065

## ACCESORIOS IP20 TLED-117 - 156

## ACCESORIOS IP65 TLED-118 - 157

ACLED - 242 Conector TIRA - CABLE RGB IP20 - 10mm PVPR 1,05€

ACLED - 244 Conector TIRA - TIRA con cable RGB - IP20 - 10mm PVPR 1,38€

ACLED - 243 Conector TIRA - TIRA RGB IP20 - 10mm PVPR 0,36€

ACLED - 245 Conector TIRA - CABLE cor cable RGB - IP65 PVPR 3,48€

ACLED - 247 Conector TIRA - TIRA con cable RGB - IP65 PVPR 5,52€

ACLED - 246 Conector TIRA - TIRA RGB - IP65 PVPR 1,74€

RGB + 3CCT

3 en 1 TRES TIPOS DE LUZ EN LA MISMA LUMINARIA

CÁLIDA NEUTRA FRÍA

Switch 3CCT

	Potencia	IP	Lúmenes	leds/metro	Metros	K°	Ref	PVPR
IP65	21w/m	IP65	1600 Lm	840	5 Metros	RGB+3CCT	TLED-172	95,34€

21 w/m 1600 Lm/m 24V 1 120°

CRI 90

Nuevo Adhesivo posterior 3M VHB EXTRA FUERTE

CONTROLADORES PARA TIRAS LED 3CCT + RGB 24V WIFI - PÁG-175 CONTR-050, CONTR-061, CONTR-062

NO WIFI PÁG-176, PÁG-178 CONTR-027, CONTR-074, CONTR-039

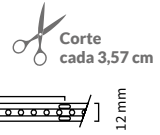

## ACCESORIOS TLED-172

ACLED - 519 Conector TIRA - TIRA COB 6P - IP20 - 12mm PVPR 0,69€

ACLED - 520 Conector TIRA - CABLE COB 6P - IP20 - 12mm PVPR 1,38€

ACLED - 521 Conector TIRA - TIRA con cable COB 6P - IP20 - 12mm PVPR 2,08€

\* Según la nueva normativa ERP ha habido un cambio en la medición de Lúmenes y vatios, pero sigue emitiendo la misma cantidad de luz. A medida que vayan entrando los nuevos modelos con ERP se irá actualizando en catálogo y cajas de color. Puede haber variación respecto a la caja del producto (comprobar en ficha técnica), todos los datos en catálogo están correctos salvo error tipográfico.

# Tira Led COB DIGITAL

**NEW!**



IP20	Potencia	IP	Lúmenes	leds/metro	Metros	K°	Ref	PVPR
	10w/m	IP20	1150 Lm	576	5 Metros	DIGITAL 2700K - 6500K	TLED-170	83,10€



5m



Compatible con CONTR-100  
Compatible con mando CONTR-101

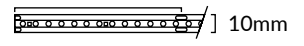

IP20	Potencia	IP	Lúmenes	leds/metro	Metros	K°	Ref	PVPR
	12w/m	IP20	1250 Lm	720	5 Metros	DIGITAL RGB	TLED-171	93,48€



5m



Compatible con CONTR-100  
Compatible con mando CONTR-101

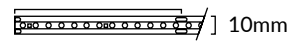

## ACCESORIOS

Ref	ACLED - 516 <b>CONECTOR TIRA-TIRA COB 3P IP20</b>	ACLED - 517 <b>CONECTOR TIRA-CABLE 3P IP20</b>	ACLED - 518 <b>CONECTOR TIRA-TIRA CABLE 3P IP20</b>
	PVPR 0,36€	PVPR 1,04€	PVPR 1,38€



# Tira Led SMD DIGITAL



Compatible con CONTR-100

IP65	Potencia	IP	Lúmenes	leds/metro	Metros	K°	Ref	PVPR
	10w/m	IP65	400 Lm	60	5 Metros	DIGITAL RGB	TLED-135	67,08€



5m

Nuevo Adhesivo posterior **3M VHB EXTRA FUERTE**



Compatible con CONTR-100  
Compatible con mando CONTR-101



## ACCESORIOS

Ref	ACLED - 249 <b>CONECTOR TIRA-CABLE 4PIN - IP64 - 10mm</b>	ACLED - 250 <b>CONECTOR TIRA-TIRA 4PIN - IP64 - 10mm</b>	ACLED - 251 <b>CONECTOR TIRA-TIRA con cable 4PIN - IP64 - 10mm</b>
	PVPR 3,72€	PVPR 1,86€	PVPR 5,91€

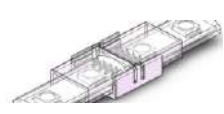

## CONTROLADOR / AMPLIFICADOR TIRA LED DIGITAL



AMPLIFICADOR TIRA LED TTL

**MÁX 200M**

Ref

ALM-049

PVPR

69,30€

Máximo 2 tiras led digitales



AMPLIFICADOR TIRA LED TTL

**6 CANALES**

Ref

ALM-050

PVPR

62,34€

Máximo 6 tiras led digitales

Compatible con TLED-170-171-135



CONTROLADOR LED 8A

**RGB/RGBW DIGITAL SPI**

Ref

CONTR-100

PVPR

73,32€



tuya

INSTRUCCIONES

VIDEO  
INSTALACIÓN



Color



Blanco



Carta de  
colores



Combinación

Personaliza completamente una gran  
cantidad de modos de color RGB / RGBW



Ritmo  
musical



Escenas



Mezcla de  
colores por  
segmentos



Temporizador



Control por  
voz



Control por  
APP



16 millones  
de colores



Ajuste de  
brillo



**PARA TIRA LED DIGITAL - Pilas CR2032 -**

MANDO NEGRO CONTROLADOR RF

**RGB / RGBW**

Ref

CONTR-101

PVPR

48,24€



**/ ZONA RGB o RGBW**

# Tira Led SMD 24V



\*Todas nuestras tiras LED son **DIMMABLES** y se pueden conectar mediante **WiFi** con su controlador correspondiente.



Tira LED SMD

ACCESORIOS Y CONTROLADORES PÁG - 171



\*SE ACONSEJA LA INSTALACIÓN DE LAS TIRAS LED CON PERFIL DISIPADOR.



Potencia	IP	Lúmenes	leds/metro	Metros		K°	Ref	PVPR
4.8w/m	IP20	473 Lm/m	60	5 Metros		3200K	TLED-025	19,11€
4.8w/m	IP20	473 Lm/m	60	5 Metros	↓	4200K	TLED-026	19,11€
4.8w/m	IP20	473 Lm/m	60	5 Metros		5000K	TLED-027	19,11€
4.8w/m	IP67	473 Lm/m	60	5 Metros		3200K	TLED-031	29,85€
4.8w/m	IP67	473 Lm/m	60	5 Metros	↓	4200K	TLED-032	29,85€
4.8w/m	IP67	473 Lm/m	60	5 Metros		5000K	TLED-033	29,85€

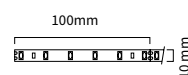
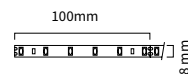

Potencia	IP	Lúmenes	leds/metro	Metros		K°	Ref	PVPR
9.6w/m	IP20	947 Lm/m	120	5 Metros		3200K	TLED-028	20,85€
9.6w/m	IP20	947 Lm/m	120	5 Metros	↓	4200K	TLED-029	20,85€
9.6w/m	IP20	947 Lm/m	120	5 Metros		6500K	TLED-030	20,85€
9.6w/m	IP67	947 Lm/m	120	5 Metros		3200K	TLED-034	37,62€
9.6w/m	IP67	947 Lm/m	120	5 Metros	↓	4200K	TLED-035	37,62€
9.6w/m	IP67	947 Lm/m	120	5 Metros		6500K	TLED-036	37,62€
9.6w/m	IP20	947 Lm/m	120	40 Metros		3200K	TLED-062	229,29€
9.6w/m	IP20	947 Lm/m	120	40 Metros	↓	4200K	TLED-063	229,29€
9.6w/m	IP20	947 Lm/m	120	40 Metros		6500K	TLED-064	229,29€
9.6w/m	IP20	947 Lm/m	120	50 Metros		3200K	TLED-082	229,29€

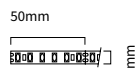
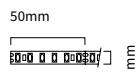
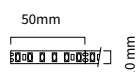
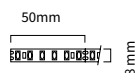

**3 NEW PRICE!!**

Potencia	IP	Lúmenes	leds/metro	Metros	K°	Ref	PVPR
14.4w/m	IP20	1250 Lm/m	60	5 Metros	3200K	TLED-008	29,70€
14.4w/m	IP20	1250 Lm/m	60	5 Metros	4200K	TLED-011	29,70€
14.4w/m	IP20	1250 Lm/m	60	5 Metros	6500K	TLED-009	29,70€
14.4w/m	IP67	1250 Lm/m	60	5 Metros	3200K	TLED-004	45,15€
14.4w/m	IP67	1250 Lm/m	60	5 Metros	4200K	TLED-012	45,15€
14.4w/m	IP67	1250 Lm/m	60	5 Metros	6500K	TLED-007	45,15€
<b>* NO SUMERGIBLE EN EL AGUA</b>							
14.4w/m	IP68	1250 Lm/m	60	5 Metros	3200K	TLED-044	62,85€
14.4w/m	IP68	1250 Lm/m	60	5 Metros	4200K	TLED-045	62,85€
14.4w/m	IP68	1250 Lm/m	60	5 Metros	6500K	TLED-046	62,85€
14.4w/m	IP20	1250 Lm/m	60	50 Metros	3200K	TLED-058	297,96€
14.4w/m	IP20	1250 Lm/m	60	50 Metros	4200K	TLED-059	297,96€
14.4w/m	IP20	1250 Lm/m	60	50 Metros	6500K	TLED-060	297,96€

Corte cada 10 cm

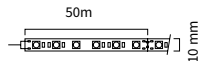
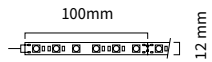
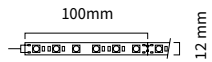
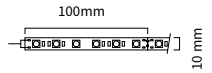

CONTROLADORES PARA TIRAS LED MONOCOLOR 24V

WIFI - PÁG-175  
CONTR-060,  
CONTR-097,  
CONTR-106

NO WIFI PÁG-176, PÁG-178  
CONTR-029, CONTR-073,  
CONTR-038, CONTR-021,  
CONTR-012, CONTR-011,  
CONTR-066, CONTR-024,  
CONTR-058, CONTR-079

**ACCESORIOS IP20**

Ref	ACLED - 058	ACLED - 054	ACLED - 059	ACLED - 055	ACLED - 231	ACLED - 060	ACLED - 061
	Conector Tira-Tira IP20 Monocolor 8mm	Conector Tira-Tira IP20 Monocolor 10mm	Conector Tira-Cable IP20 Monocolor 8mm	Conector Tira-Cable IP20 Monocolor 10mm	Conector rápido Tira-Cable IP20 Monocolor 10mm	Conector cable 2 hilos "I"	Conector cable 2 hilos "T"
PVPR	1,62€	1,83€	1,62€	1,83€	1,62€	2,61€	2,79€

**ACCESORIOS IP65**

Ref	ACLED-111	ACLED-112	ACLED-113
	Conector rápido Tira-Cable 10mm monocolor IP68	Conector rápido Tira-Tira Cable 10mm monocolor IP68	Conector rápido Tira-Tira 10mm monocolor IP68
PVPR	3,18€	4,56€	3,48€

**3 en 1 TRES TIPOS DE LUZ EN LA MISMA LUMINARIA**



\* Necesario conexión con controlador para hacer el 3CCT

Potencia	IP	Lúmenes	leds/metro	Metros	K°	Ref	PVPR
8.4w/m	IP20	1100 Lm/m	60	5 Metros	3CCT	TLED-037	48,48€
8.4w/m	IP67	1100 Lm/m	60	5 Metros	3CCT	TLED-038	56,58€

Corte cada 10 cm

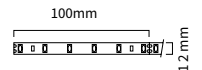
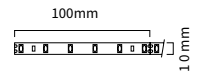

CONTROLADORES PARA TIRAS LED 3CCT 24V

WIFI - PÁG-175  
CONTR-060, CONTR-097,  
CONTR-108, CONTR-109,  
CONTR-061, CONTR-062

NO WIFI PÁG-176, PÁG-178  
CONTR-029, CONTR-027,  
CONTR-073, CONTR-074,  
CONTR-021, CONTR-012,  
CONTR-011, CONTR-066,  
CONTR-024, CONTR-058,  
CONTR-079

**ACCESORIOS 3CCT IP20**

Ref	ACLED-267	ACLED-268	ACLED-269
	Conector rápido TIRA - TIRA con cable IP20	Conector rápido TIRA - CABLE IP20	Conector rápido TIRA - TIRA IP20
	TLED-037	TLED-037	TLED-037
PVPR	3,27€	4,71€	3,54€

**ACCESORIOS 3CCT IP68**

Ref	ACLED-114	ACLED-115	ACLED-116
	Conector rápido Tira-Cable 10mm 3CCT IP68	Conector rápido Tira-Tira Cable 10mm 3CCT IP68	Conector rápido Tira-Tira 10mm 3CCT IP68
	TLED-038	TLED-038	TLED-038
PVPR	3,27€	4,71€	3,54€

\* Según la nueva normativa ERP ha habido un cambio en la medición de Lúmenes y vatios, pero sigue emitiendo la misma cantidad de luz.

A medida que vayan entrando los nuevos modelos con ERP se irá actualizando en catálogo y cajas de color.

Puede haber variación respecto a la caja del producto (comprobar en ficha técnica), todos los datos en catálogo están correctos salvo error tipográfico.

# Serie Tiras Led SMD RGB / RGB + 3CCT

## Tira led **SMD RGB High Efficiency**

**NEW PRICE!!**



Potencia	IP	Lúmenes	leds/metro	Metros	K°	Ref	PVPR
14w/m	IP20	1250 Lm/m	60	5 Metros	RGB	TLED-010	29,70€
14w/m	IP20	1250 Lm/m	60	50 Metros	RGB	TLED-061	339,42€
14w/m	IP67	1000 Lm/m	60	5 Metros	RGB	TLED-006	50,37€
14w/m	IP68	1000 Lm/m	60	5 Metros	RGB	TLED-047	62,85€

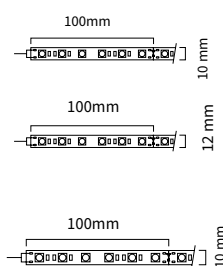

**NO SUMERGIBLE EN EL AGUA**

### ACCESORIOS TLED-010 - 061 - IP20

### ACCESORIOS TLED-006 - 047 - IP65

Ref	ACLED - 056	ACLED - 057	Ref	ACLED-117	ACLED-118	ACLED-119
	Conector Tira-Tira IP20 RGB 10mm	Conector Tira-Cable IP20 RGB 10mm		Conector rápido Tira-Cable 10mm RGB IP68	Conector rápido Tira-Tira Cable 10mm RGB IP68	Conector rápido Tira-Tira 10mm RGB IP68
PVPR	2,16€	2,16€	PVPR	3,33€	4,77€	3,75€

**CONTROLADORES PARA TIRAS LED RGB 24V**  
WIFI - PÁG-175  
CONTR-050, CONTR-061,  
CONTR-062, CONTR-080

**NO WIFI PÁG-176, PÁG-178**  
CONTR-027, CONTR-074,  
CONTR-039, CONTR-020,  
CONTR-078, CONTR-037,  
CONTR-049, CONTR-014,  
CONTR-013, CONTR-018  
CONTR-065

Ref	ACLED - 205	ACLED - 206
	Conector rápido LED TIRA-CABLE 4-PIN 10MM RGB IP66	Conector rápido LED TIRA-TIRA 4-PIN 10MM RGB IP66
PVPR	3,06€	3,06€

### 3 en 1 TRES TIPOS DE LUZ EN LA MISMA LUMINARIA

**RGB + 3CCT**

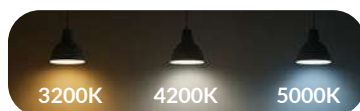

**NEW PRICE!!**

### 6 HILOS



Potencia	IP	Lúmenes	leds/metro	Metros	K°	Ref	PVPR
11,2w/m	IP20	1100 Lm/m	72	5 Metros	3CCT + RGB	TLED-039	71,70€
11,2w/m	IP67	1100 Lm/m	72	5 Metros	3CCT + RGB	TLED-040	83,85€

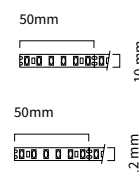

**CONTROLADORES PARA TIRAS LED 3CCT + RGB 24V**  
WIFI - PÁG-175  
CONTR-050, CONTR-061,  
CONTR-062

**NO WIFI PÁG-176, PÁG-178**  
CONTR-027,  
CONTR-074,  
CONTR-039



**High Efficiency**  
240 LEDs / M



## ALTA DISIPACIÓN TÉRMICA

Used  
**SAMSUNG**  
LED Chips

**ALTA**  
LUMINOSIDAD

La **Tira LED High Efficiency 24V 240 LED/m** es la elección perfecta para iluminación de cualquier espacio.

Ya que cuenta con una cantidad de **240Leds** por metro. Tiene una buena disipación de la temperatura lo que contribuye a un consumo muy poco y ahorro energético. Además cuenta con un chip **SAMSUNG** lo que hace tener una vida duradera.

**21.6** w/m  
**3000** Lm/m  
**150** Lm/W  
**240** LEDs/M

	Potencia	IP	Lúmenes	leds/metro	Metros	K°	Ref	PVPR
IP20	21.6w/m	IP20	3000 Lm/m	240	5 Metros	3000K	TLED-108	89,70€
	21.6w/m	IP20	3000 Lm/m	240	5 Metros	4000K	TLED-109	89,70€
	21.6w/m	IP20	3000 Lm/m	240	5 Metros	6000K	TLED-110	89,70€
IP20	21.6w/m	IP20	3000 Lm/m	240	5 Metros	3000K	TLED-111	107,70€
	21.6w/m	IP20	3000 Lm/m	240	5 Metros	4000K	TLED-112	107,70€
	21.6w/m	IP20	3000 Lm/m	240	5 Metros	6000K	TLED-113	107,70€

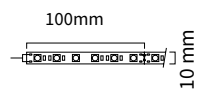

**21.6** w/m  
**3000** Lm/m  
**24V**  
**1**  
**120°**  
**IP 20**  
**IP 65**  
**5 M**

Nuevo Adhesivo posterior  
**3M VHB EXTRA FUERTE**



**CONTROLADORES**  
**PARA TIRAS LED**  
**MONOCOLOR 24V**

**WIFI - PÁG-175**  
CONTR-060,  
CONTR-097,  
CONTR-106

**NO WIFI PÁG-176, PÁG-178**  
CONTR-029, CONTR-073,  
CONTR-038, CONTR-021,  
CONTR-012, CONTR-011,  
CONTR-066, CONTR-024,  
CONTR-058, CONTR-079

\* Según la nueva normativa ERP ha habido un cambio en la medición de Lúmenes y vatios, pero sigue emitiendo la misma cantidad de luz.

A medida que vayan entrando los nuevos modelos con ERP se irá actualizando en catálogo y cajas de color.

Puede haber variación respecto a la caja del producto (comprobar en ficha técnica), todos los datos en catálogo están correctos salvo error tipográfico.

## Sensor escalera

NEW!



### CONTROLADOR LUZ ESCALERA CON SENSOR PIR

Ref	PVPR
CONTR-102	283,20€



32 CANALES / 1A (CANAL)

 [INSTRUCCIONES](#)

 [VIDEO  
INSTALACIÓN](#)

#### Incluye:

- PIR Sensor 2Ud (1,2mts)
- Sensor de luz diurna
- Cable sensor PIR (5mts)
- Número de luces de escalera ajustable, máx. 32 peldaños
- 8 velocidades de iluminación graduadas ajustables
- 4 modos de iluminación de trabajo opcionales
- Dos controladores de luz de escalera pueden funcionar en cascada
- Control de interruptor pulsador opcional



### CABEZAL SENSOR DE MOVIMIENTO PIR

Ref	PVPR
CONTR-103	26,82€

## Serie controlador tiras led domótica

Hasta 5 canales (5 en 1), diferentes colores, con un mismo controlador en un mismo lugar.

Función 5 en 1 solo en CONTR-108, 109, 061, 062

App  
tuya

### Convierte y controla tu instalación de tiras LED en WiFi



#### PARA TIRAS MONOCOLOR

Compatible con CONTR-107 - NO INCLUIDO

\* FUNCIONA CON MANDO, y APP Tuya

PASTILLA REGULACIÓN TIRA LED MONO	WIFI 10A - 240W	Ref	PVPR
		CONTR-106	70,20€



tuya

Máx: 10A - 2.4GHz

\* COMPATIBLE CON MANDO CONTR-107

\* COMPATIBLE CON APP TUYA SMART LIFE.

48,60€



#### PARA TIRAS 3CCT y MONOCOLOR

\* FUNCIONA CON PULSADOR, y APP Tuya

CONTROLADOR TIRA LED 3CCT	WIFI	Ref	PVPR
		CONTR-060	68,46€



tuya

Máx: 10.5A - 5A/CH - 2 canales - 2.4GHz

\* COMPATIBLE CON APP TUYA SMART LIFE.



#### PARA TIRAS 3CCT y MONOCOLOR

\* FUNCIONA CON PULSADOR, Mando, y APP Tuya

CONTROLADOR TIRA LED 2 EN 1	WIFI	Ref	PVPR
		CONTR-097	68,46€



tuya

Máx: 12A - 12A/CH - 2 canales - 2.4GHz

\* COMPATIBLE CON APP TUYA SMART LIFE.

\* COMPATIBLE CON MANDO CONTR-030



#### PARA TIRAS 3CCT, RGB+W y 3CCT+RGB

\* FUNCIONA CON PULSADOR, Mando, y APP Tuya

CONTROLADOR TIRA LED 5 EN 1	WIFI	Ref	PVPR
		CONTR-108	63,75€



tuya

Máx: 20A - 15A/CH - 5 canales - 2.4GHz

\* COMPATIBLE CON APP TUYA SMART LIFE.

\* COMPATIBLE CON MANDO CONTR-110



#### PARA TIRAS 3CCT, RGB+W y 3CCT+RGB

\* FUNCIONA CON PULSADOR, Mando, y APP Tuya

CONTROLADOR MINI TIRA LED 5 EN 1	WIFI	Ref	PVPR
		CONTR-109	59,85€



tuya

Máx: 10A - 6A/CH - 5 canales - 2.4GHz

\* COMPATIBLE CON APP TUYA SMART LIFE.

\* COMPATIBLE CON MANDO CONTR-110



#### PARA TIRAS 3CCT, RGB+W y 3CCT+RGB

\* FUNCIONA CON APP Tuya

CONTROLADOR TIRA LED 5 EN 1	WIFI	Ref	PVPR
		CONTR-061	75,87€



CONTROLADOR TIRA LED 5 EN 1	WIFI - BLUETOOTH	Ref	PVPR
		CONTR-062	70,98€



tuya

Máx: 15A - 3A/CH - 5 canales - 2.4GHz

\* COMPATIBLE CON APP TUYA SMART LIFE.



#### PARA TIRAS RGB 24V - CODIFICADO

\* FUNCIONA CON APP Tuya Y CONTROL REMOTO INCLUIDO

CONTROLADOR TIRA LED RGB	WIFI	Ref	PVPR
		CONTR-080	101,40€



tuya

Máx: 15A - 3A/CH - 3 canales - 2.4GHz

\* COMPATIBLE CON APP TUYA SMART LIFE.

\* Según la nueva normativa ERP ha habido un cambio en la medición de Lúmenes y vatios, pero sigue emitiendo la misma cantidad de luz.

A medida que vayan entrando los nuevos modelos con ERP se irá actualizando en catálogo y cajas de color.

Puede haber variación respecto la caja del producto (comprobar en ficha técnica), todos los datos en catálogo están correctos salvo error tipográfico.



## CONTROLADORES 3CCT Y RGB



### PARA TIRAS 3CCT y MONOCOLOR

\* FUNCIONA CON MANDO

Ref

PVPR

CONTROLADOR MiLight TIRA LED 3CCT

CONTR-029

35,07€



Máx: 10A - 20A/CH - 2 canales - 2.4GHz

\* COMPATIBLE CON MANDO CONTR-030



### PARA TIRAS 3CCT, RGB+W y 3CCT+RGB

\* FUNCIONA CON MANDO

CONTROLADOR MiLight TIRA LED 5 EN 1

CONTR-027

49,83€



Máx: 15A - 6A/CH - 5 canales - 2.4GHz

\* COMPATIBLE CON MANDO CONTR-028 (RGB Y 3CCT) CONTR-030 (MONOCOLOR O DUAL)



### PARA TIRAS 3CCT y MONOCOLOR

\* FUNCIONA CON PULSADOR O CON MANDO

CONTROLADOR TIRA LED 3CCT

CONTR-073

56,10€



Máx: 20A - 20A/CH - 2 canales - 2.4GHz

\* COMPATIBLE CON MANDO CONTR-030



### PARA TIRAS 3CCT, RGB+W y 3CCT+RGB

\* FUNCIONA CON PULSADOR O CON MANDO

CONTROLADOR TIRA LED 3CCT

CONTR-074

56,10€



Máx: 10A - 20A/CH - 5 canales - 2.4GHz

\* COMPATIBLE CON MANDO CONTR-028 (RGB Y 3CCT) CONTR-030 (MONOCOLOR O DUAL)



\* COMPATIBLE CON MI-LIGHT / CONEXIÓN MICRO USB  
\* Sólo para dispositivos MiBoxer



CONVERTIDOR DE RF a WIFI 2,4G

CONTR-044

71,91€



Convierte un controlador de Radiofrecuencia en WIFI.



“Compatible con los principales asistentes de voz (asistente de Google\*, Amazon\*, Alexa\* ... etc.)”

Estas marcas son propiedad de sus respectivos propietarios, y como tal, son reconocidas por Atmos Electric Equipment S.L y son utilizadas únicamente con fines enunciativos.



(Para controlador CONTR-027, CONTR-029, CONTR-050)

AMPLIFICADOR SEÑAL 5 CANALES

6A / CH

ALM-035

44,76 €



## PASTILLA REGULADORA



Máx. 6A - Push+RF

Ref

PVPR

PASTILLA REGULADORA TIRA DE LED

MONOCOLOR

CONTR-038

54,69€



MANDO PARA PASTILLA REGULACIÓN

PARA CONTR-038

CONTR-098

47,31€



2.4GHz - 4 zonas - TIRA LED MONOCOLOR



MÁXIMO 4A - 4A POR CANAL - PUSH+RF

PASTILLA REGULADORA TIRA DE LED

RGBW / 3CCT

CONTR-039

48,78€



MANDO PARA PASTILLA REGULADORA 1 ZONA

PARA CONTR-039

CONTR-099

49,83€



2.4Ghz - 1 zona - TIRA LED RGB / 3CCT



**CONTROLADORES RGB**

		Ref	PVPR
	Incluye mando con sensor infrarrojo - 6A - Mando 24 teclas		
	CONTROLADOR RGB	78w	CONTR-020 14,37€
	Incluye mando con sensor infrarrojo - 6A - Mando 40 teclas		
	CONTROLADOR RGB	78w	CONTR-078 14,37€
	Incluye mando con radiofrecuencia 6A		
	CONTROLADOR RGB MINI RF	144W	CONTR-037 18,06€
	Hasta 4 tiras al mismo tiempo.		
	CONTROLADOR LED TIRA RGB MUSICAL 24V -	432W	CONTR-049 90,12€
	Incluye mando con radiofrecuencia - Conexión RED RJ45		
	CONTROLADOR RGB MANDO SLIM RED	576W	CONTR-014 54,96€
	Incluye mando con radiofrecuencia - Conexión RED RJ45		
	CONTROLADOR RGB MANDO TACTIL	576W	CONTR-013 72,06€
	Incluye mando con radiofrecuencia - Conexión RED RJ45		
	CONTROLADOR RGB MANDO	576W	CONTR-018 71,49€
	Para tiras LED 24V - 2.4GHz - Salida 6A / 4 canales		
	CONTROLADOR LED RGBW	24V 576W 6A 4CH	CONTR-065 81,48€

\* Según la nueva normativa ERP ha habido un cambio en la medición de Lúmenes y vatios, pero sigue emitiendo la misma cantidad de luz. A medida que vayan entrando los nuevos modelos con ERP se irá actualizando en catálogo y cajas de color. Puede haber variación respecto la caja del producto (comprobar en ficha técnica), todos los datos en catálogo están correctos salvo error tipográfico.



Para tiras LED 24V Medidas: Ancho 164mm - Profundidad 65mm - Altura 40mm  
Control señal: DMX512 (XLR/RJ45). Salida: 4 canales (RGBW)

**CONTROLADOR LED *DMX512* 4 CANALES 8A** Ref: CONTR-064 PVPR: 69,81€



AMPLIFICADOR LED RGB 576W ALM-011 39,75€  
AMPLIFICADOR LED RGB **NEW!** 30A - 10A x 3 canales 720W ALM-047 42,78€



**CONTROLADORES MONOCOLOR / 3CCT**



Incluye mando infrarrojo - Incluye conector

**CONTROLADOR SLIM MONOCOLOR 144W** CONTR-021 9,78€



Incluye mando codificado

**CONTROLADOR MONOCOLOR 192W** CONTR-012 28,86€



Incluye mando con radiofrecuencia - Mando no codificado

**CONTROLADOR MONOCOLOR 600W** CONTR-011 57,60€



Control remoto RF - 3 CANALES - 3CCT

**CONTROLADOR LED MONOCOLOR 24V-10A \* 3CH RED** CONTR-066 66,45€

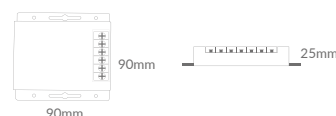

Regulación por pulsador y potenciómetro  
PARA TIRAS MONOCOLOR - Hasta 4 tiras

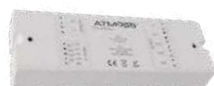

**REGULADOR I-10V 4CH x 8A 8A 4 CH** CONTR-024 173,34€



Función Push y RF 2.4Ghz - PARA TIRAS MONOCOLOR

**CONTROLADOR LED DIMMABLE 24V-288W 0/1 - 10V** CONTR-058 44,76€



Con sensor infrarrojo - Distancia detección 80mm

**CONTROLADOR LED MONO 24V - 5A SENSOR Y SWITCH** CONTR-079 14,37€



**AMPLIFICADOR SEÑAL MONOCOLOR 720W** ALM-032 53,85€





## MANDO CONTROL REMOTO



2,4GHz - 4 Zonas Para tiras LED MONOCOLOR O 3CCT

Compatible con **CONTR-029, CONTR-027, CONTR-097, CONTR-073**

Ref PVPR

MANDO PARA CONTROLAR TIRA LED

CONTR-030 23,13€



2,4GHz - 8 Zonas Para tiras LED RGB y 3CCT

Compatible con **CONTR-027, CONTR-074**

MANDO PARA CONTROLAR TIRA LED

CONTR-028 54,15€



NEW!



2,4GHz - 8 Zonas Para tiras LED RGB y 3CCT

Compatible con **CONTR-108, CONTR-109**

MANDO PARA CONTROLAR TIRA LED

CONTR-110 49,56€



NEW!



**PARA TLED MONOCOLOR Y DUAL COLOR**

**PARA CONTR-038 Y CONTR-022**

RUEDA TÁCTIL - Pilas x2 AAA

Ref PVPR

MANDO RF 4 ZONAS 3 ESCENAS **MONO / CCT**

CONTR-098 64,26€



**4 ZONAS - 3 ESCENAS**

NEW!



**PARA TLED RGB Y RGBW**

**PARA CONTR-039**

RUEDA TÁCTIL - Pilas x2 AAA

Ref PVPR

MANDO RF 1 ZONAS 2 ESCENAS **RGB / RGBW**

CONTR-099 64,26€



**1 ZONA - 2 ESCENAS**

## CONTROLADORES DE PARED



Para tiras 3CCT, RGB+W y 3CCT+RGB - MÁXIMO 15A

CONTROLADOR TACTIL DE PARED TIRA LED

**EMPOTRABLE**

CONTR-031 68,61€



Para tiras 3CCT - MÁXIMO 15A

CONTROLADOR TACTIL DE PARED TIRA LED

**EMPOTRABLE**

CONTR-026 61,41€





## SENSORES

2,4GHz - Sensor infrarrojo 120° - 0/5metros - **45segundos**

Para tira perfil 3A - 24V

Medidas: 38x12x1.2mm



**SENSOR DE MOVIMIENTO INFRARROJO MINI**

ACLED-132

11,22€



2,4GHz - Distancia de detección 80mm

Para tira perfil 5A - 24V **REGULABLE**

Medidas: 40x12x1.2mm



**SENSOR DE MOVIMIENTO MANO IR MINI**

ACLED-155

7,17€



2,4GHz - POTENCIA MÁXIMA 120W

Para tira perfil 5A - 24V **REGULABLE**

Medidas: 38x12x1.2mm



**CONTROLADOR TOUCH MINI**

CONTR-057

7,17€

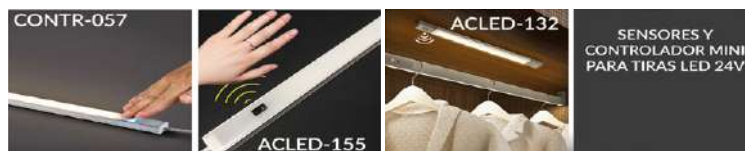



# PERFILES LED DE EMPOTRAR CON

**NEW PRICE!!**

## Perfil led - Empotrar 24V

Todos los perfiles viene incluidos las tapas finales, garras de sujeción y el difusor.



Longitud 2m Difusor OPAL

PROTECTOR ALUMINIO TIRA LED *IP44 EMPOTRAR* Ref ACLED-021 PVPR 10,08€

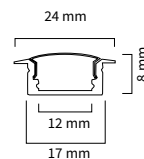

Longitud 2m Difusor OPAL

PROTECTOR ALUMINIO TIRA LED *BLANCO IP44 EMPOTRAR* Ref PRF-225 PVPR 10,50€

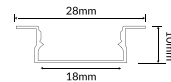

Longitud 2m Difusor OPAL

PROTECTOR ALUMINIO TIRA LED *BLANCO IP44 EMPOTRAR* Ref PRF-226 PVPR 11,52€



Longitud 2m Difusor OPAL

PROTECTOR ALUMINIO TIRA LED *IP44 EMPOTRAR* Ref PRF-221 PVPR 8,94€

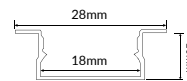

Longitud 2m Difusor OPAL - Color Negro

PROTECTOR ALUMINIO NEGRO TIRA LED *IP44 EMPOTRAR* Ref ACLED-139 PVPR 11,88€

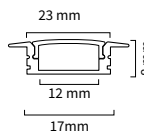

Longitud 2m Difusor OPAL

PROTECTOR ALUMINIO TIRA LED *IP44 EMPOTRAR* Ref ACLED-052 PVPR 11,55€

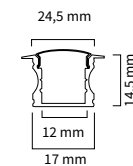

Longitud 2m Difusor OPAL

PROTECTOR ALUMINIO TIRA LED *BLANCO IP44 EMPOTRAR* Ref ACLED-153 PVPR 13,50€

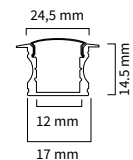

Longitud 2m Difusor OPAL - Solo para Tiras de LED IP20

PROTECTOR ALUMINIO PARA DOBLE TIRA LED IP20 *EMPOTRAR* Ref ACLED-178 PVPR 24,30€

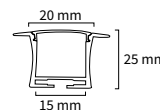

Longitud 2m Difusor OPAL

PROTECTOR ALUMINIO TIRA LED *IP44 EMPOTRAR* Ref PRF-227 PVPR 13,95€

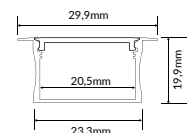

\* Según la nueva normativa ERP ha habido un cambio en la medición de Lúmenes y vatios, pero sigue emitiendo la misma cantidad de luz.

A medida que vayan entrando los nuevos modelos con ERP se irá actualizando en catálogo y cajas de color.

Puede haber variación respecto la caja del producto (comprobar en ficha técnica), todos los datos en catálogo están correctos salvo error tipográfico.

# Perfil led - Superficie 24v

Todos los perfiles viene incluidos las tapas finales, garras de sujeción y el difusor.

**NEW PRICE!!**



Longitud 2m Difusor OPAL

PROTECTOR ALUMINIO ANGULAR TIRA LED *SUPERFICIE* Ref PRF-220 PVPR 8,94€

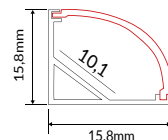

Longitud 2m Difusor OPAL

PROTECTOR ALUMINIO ANGULAR TIRA LED *SUPERFICIE* Ref PRF-224 PVPR 10,38€

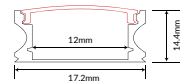

Longitud 2m Difusor OPAL

PROTECTOR ALUMINIO BLANCO TIRA LED *SUPERFICIE* Ref ACLED-136 PVPR 11,01€

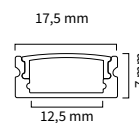

Longitud 2m Difusor OPAL

PROTECTOR ALUMINIO NEGRO TIRA LED *SUPERFICIE* Ref ACLED-137 PVPR 11,01€

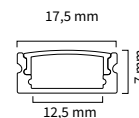

Longitud 2m Difusor OPAL

PROTECTOR ALUMINIO TIRA LED *SUPERFICIE* Ref ACLED-022 PVPR 9,33€

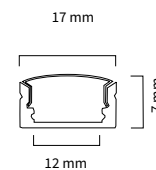

Longitud 2m Difusor OPAL

PROTECTOR ALUMINIO TIRA LED *SUPERFICIE* Ref ACLED-091 PVPR 11,94€  
 PROTECTOR ALUMINIO BLANCO TIRA LED *SUPERFICIE* Ref ACLED-170 PVPR 13,02€

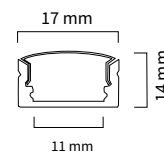



Longitud 2m Difusor OPAL

PROTECTOR ALUMINIO FLEXIBLE TIRA LED SUPERFICIE Ref ACLED-045 PVPR 6,90€

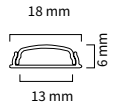

Longitud 2m Difusor OPAL

PROTECTOR ALUMINIO ANGULAR TIRA LED SUPERFICIE ACLED-023 8,94€

PROTECTOR ALUMINIO ANGULAR BLANCO TIRA LED SUPERFICIE ACLED-216 9,45€

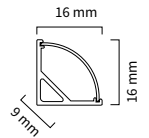

Longitud 2m

PROTECTOR ALUMINIO DISIPADOR TIRA LED SUPERFICIE ACLED-097 11,13€



Longitud 2m Difusor OPAL

PROTECTOR ALUMINIO DOBLE TIRA LED SUPERFICIE ACLED-140 20,46€

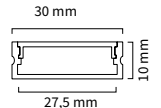

PROTECTOR ALUMINIO TIRA LED 230V - SUPERFICIE / EMPOTRAR



PROTECTOR ALUMINIO 230V TIRA LED SUPERFICIE ACLED-135 13,35€

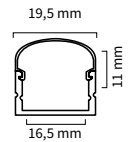

PROTECTOR ALUMINIO 230V TIRA LED SUPERFICIE PRF-222 8,94€

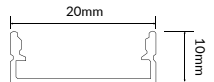

PROTECTOR ALUMINIO 230V TIRA LED EMPOTRAR PRF-223 11,01€

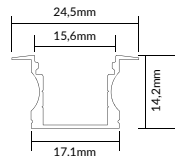

PROTECTORES DE ALUMINIO - TIRAS DE LED 24V



Ref ACLED - 038 Tapa para perfil de aluminio empotrar (2u). Para ACLED-021

Ref ACLED - 039 Tapa para perfil de aluminio superficie (2u). Para ACLED-022

Ref ACLED - 040 Tapa para perfil de aluminio angular (2u). Para ACLED-023

Ref ACLED - 095 Tapa para perfil de aluminio superficie (2u). Para ACLED-091

Ref ACLED - 096 Tapa para perfil de aluminio empotrar (2u). Para ACLED-052

Ref ACLED - 255 Tapa final 12x5mm CON AGUJERO

Ref ACLED - 256 Tapa final 12x5mm SIN AGUJERO

PVPR 0,72€ 0,72€ 0,72€ 0,72€ 0,72€ 0,24€ 0,24€



Ref ACLED - 041 Grapa sujeción clips enganches perfil aluminio angular

Ref ACLED - 042 Grapa sujeción clips enganches perfil aluminio superficie

Ref ACLED - 043 Grapa sujeción clips enganches perfil aluminio empotrar

Ref ACLED - 053 Difusor OPAL para perfil aluminio de Tira LED 2mts

Ref ACLED - 109 Difusor OPAL para perfil aluminio angular de Tira LED 2mts

PVPR 0,54€ 0,54€ 0,54€ 3,60€ 3,60€

\* Según la nueva normativa ERP ha habido un cambio en la medición de Lúmenes y vatios, pero sigue emitiendo la misma cantidad de luz. A medida que vayan entrando los nuevos modelos con ERP se irá actualizando en catálogo y cajas de color. Puede haber variación respecto la caja del producto (comprobar en ficha técnica), todos los datos en catálogo están correctos salvo error tipográfico.



# ALIMENTADOR TIRA DE LED ATMOSS<sup>®</sup> IP20 | IP67

GRAN

Calidad / Durabilidad

ALTA

Versatilidad / Disipación



COMFORT VISUAL Encendido y apagado de forma progresiva

## Alimentador Tira LED ATMOSS



Ref	ALM-036	ALM-037	ALM-038	ALM-039	ALM-040
	60W 24V IP20	100W 24V IP20	150W 24V IP20	200W 24V IP20	300W 24V IP20
PVPR	27,99€	38,49€	44,85€	55,98€	70,29€



Ref	ALM-041	ALM-042	ALM-043	ALM-044	ALM-045	ALM-046
	60W 24V IP67	100W 24V IP67	150W 24V IP67	200W 24V IP67	300W 24V IP67	600W 24V IP67
PVPR	34,98€	60,42€	78,87€	87,45€	108,45€	153,90€



## Alimentador Tira LED MEANWELL



Ref	ALM-029	ALM-019	ALM-030	ALM-020	ALM-031	ALM-016	ALM-017	ALM-021
	35W 24V	50W 24V	75W 24V	100W 24V	150W 24V	200W 24V	350W 24V	600W 24V
PVPR	40,08€	41,34€	50,10€	56,34€	68,85€	91,35€	117,66€	343,05€



	Ref	PVPR
ALIMENTADOR MEANWELL LPV	35W-24V ESTANCO IP67	ALM-022 45,51€
ALIMENTADOR MEANWELL LPV	60W-24V ESTANCO IP67	ALM-023 50,10€
ALIMENTADOR MEANWELL LPV	100W-24V ESTANCO IP67	ALM-024 77,67€
ALIMENTADOR MEANWELL LPV	150W-24V ESTANCO IP67	ALM-025 110,16€



Tensión de salida 24V - Rango de entrada 100 - 305V - 10A



ALIMENTADOR MEANWELL ELG-240 - 240W	Ref	PVPR
	ALM-034	211,77€



# Accesorios



ACCESORIOS TIRA LED COB 230V

COB



## ACCESORIOS PARA TLED 158-159-160-161

Ref **Enchufe conexión IP65 ACLED - 237**  
PVPR 6,54€



**Conector TIRA - TIRA IP65 ACLED - 239**  
PVPR 1,74€



**Conector ESQUINA IP65 ACLED - 240**  
PVPR 2,46€



**Tapa FINAL IP65 ACLED - 241**  
PVPR 0,36€



Ref **Conector TIRA - CABLE 1,5m P65 ACLED - 238**  
PVPR 8,31€



## ACCESORIOS PARA TLED 126-127-128-129

**ACLED - 497** PVPR 2,61€  
**Enchufe conexión 12mm - P65**



**ACLED - 498** PVPR 0,36€  
**Cable 1 metro sin enchufe 12mm - P65**



**ACLED - 496** PVPR 1,86€  
**Conector TIRA - TIRA recto 12mm - P65**



**ACLED - 494** PVPR 7,08€  
**Conector TIRA-TIRA esquina 12mm - P65**



**ACLED - 495** PVPR 8,94€  
**Tapa final 12mm - P65**



## ACCESORIOS PARA TLED 114-115-116

Necesario conexión con ACLED-201 **ACLED - 201** PVPR 7,80€  
**Enchufe conexión 230V 12mm - P65**



**ACLED-202** PVPR 0,48€  
**Tapa final 230V COB**



**ACLED-203** PVPR 4,50€  
**Conector TIRA-TIRA**



**ACLED-204** PVPR 0,48€  
**Grapa PVC**



**CONTR-077** PVPR 68,46€  
**CONTROLADOR TIRA COB MONOCOLOR INFRARROJO 230V 720W MÁX 50MTS**



ACCESORIOS TIRA LED SMD 230V

SMD



## ACCESORIOS PARA TLED 169-119-120-121

**ACLED - 232** PVPR 6,21€  
**Enchufe conexión**



**ACLED - 222** PVPR 1,56€  
**Conector medio 2PIN TIRA - TIRA**



**ACLED - 220** PVPR 0,24€  
**Grapa PVC**



**ACLED - 221** PVPR 0,24€  
**Tapa final**



\* ENCHUFE DE CONEXIÓN INCLUIDO

## ACCESORIOS PARA TLED 070-071-072

**ACLED - 154** PVPR 7,08€  
**Enchufe conexión Tira LED 2835 230V**



**ACLED - 126** PVPR 3,06€  
**Conector para tira 3528 c/tornillos 230v MONOCOLOR**



**ACLED - 127** PVPR 0,87€  
**Tapa inicial para tira 3528 230v MONOCOLOR**



**ACLED - 128** PVPR 0,81€  
**Tapa final para tira 3528 230v MONOCOLOR**



\* ENCHUFE DE CONEXIÓN INCLUIDO

**ACLED - 129** PVPR 0,66€  
**Cable 15cm para tira 3528 230v MONOCOLOR**



**ACLED - 130** PVPR 2,16€  
**Silicona para tira 3528 230v MONOCOLOR**



**ACLED - 154** PVPR 7,08€  
**Enchufe conexión Tira LED 2835 230V MONOCOLOR**



**ACLED - 158** PVPR 0,54€  
**Tapa final para Tira LED 2835 230V MONOCOLOR**



**ACLED - 159** PVPR 4,20€  
**Conector cable unión tira-tira Tira LED 2835 230V MONOCOLOR**



**ACLED - 160** PVPR 0,45€  
**Grapa rígida Tira LED 2835 230V MONOCOLOR**



**CONTR - 055** PVPR 57,06€  
**Controlador LED tira 2835 - 230V MONOCOLOR Máx. 50 mts.**



\* Según la nueva normativa ERP ha habido un cambio en la medición de Lúmenes y vatios, pero sigue emitiendo la misma cantidad de luz.

A medida que vayan entrando los nuevos modelos con ERP se irá actualizando en catálogo y cajas de color.

Puede haber variación respecto a la caja del producto (comprobar en ficha técnica), todos los datos en catálogo están correctos salvo error tipográfico.

ACCESORIOS PARA **TLED-457-458-459**

ACLED - 460  
Enchufe conexión  
Tira LED 230V Samsung

PVPR  
7,08€



ACLED - 461  
Conector rápido TIRA - TIRA  
Samsung - 230V Monocolor

PVPR  
7,08€

ACCESORIOS PARA **TLED-041-065-042**

ACLED - 070  
Conector recto Tira  
MONOCOLOR

PVPR  
1,56€



ACLED - 077  
Conector 2 pin cable  
unión Tira Monocolor

PVPR  
4,20€



ACLED - 073  
Grapa PVC Tira  
MONOCOLOR

PVPR  
0,24€



ACLED - 067  
Enchufe conexión Tira  
MONOCOLOR

PVPR  
6,21€



CONTR - 033  
Controlador LED tira  
MONOCOLOR  
Máx. 80 mts.

PVPR  
66,12€



ACLED - 071  
Tapa final Tira  
MONOCOLOR

PVPR  
0,24€



CONTR - 034  
Controlador LED  
tira IR 230V.  
MONOCOLOR  
Máx. 50 mts.

PVPR  
33,24€



ACLED - 068  
Conector 2 Pin Tira  
MONOCOLOR

PVPR  
0,66€

ACCESORIOS PARA **TLED-043**

ACLED - 072  
Tapa final para  
Tira RGB

PVPR  
0,39€



ACLED - 074  
Grapa PVC  
Tira RGB

PVPR  
0,39€



CONTR - 032  
Controlador para  
Tira RGB  
CONEXIÓN POR  
PRESIÓN

PVPR  
28,74€



ACLED - 075  
Conector 4 PIN  
Tira RGB

PVPR  
2,73€



ACLED - 069  
Conector cable  
Tira RGB

PVPR  
4,20€



CONTR - 072  
Controlador para  
Tira RGB  
CONEXIÓN POR  
PINCHO

PVPR  
28,74€

## ACCESORIOS TIRA LED 230V

## NEON FLEX

ACCESORIOS PARA **TLED-125-122-123-124**

ACLED - 487  
Enchufe conexión  
tira led neon flex

PVPR  
3,48€



ACLED - 488  
Tapa final para  
tira led neon flex

PVPR  
0,39€



ACLED - 400  
Grapa PLS  
transparente

PVPR  
0,39€

ACCESORIOS PARA **TLED-069-086**

ACLED - 148  
Enchufe conexión  
tira led neón  
Multicolor 230v  
PARA TLED-069

PVPR  
11,94€



ACLED - 175  
Enchufe conexión  
tira led neón  
RGB 230v  
PARA TLED-069

PVPR  
10,38€



CONTR-072  
Controlador para  
Tira led  
RGB 230v  
PARA TLED-086  
CONEXIÓN POR PINCHO

PVPR  
28,74€



ACLED - 072  
Tapa final para  
Tira RGB

PVPR  
0,39€

## ACCESORIOS TIRA LED 230V

## COB OPAL

ACCESORIOS PARA **TLED-152-153-154-155**

Ref

Enchufe conexión  
IP65 ACLED - 237



PVPR 6,54€

Conector TIRA - TIRA  
IP65 ACLED - 239



PVPR 1,74€

Conector ESQUINA  
IP65 ACLED - 240



PVPR 2,46€

Tapa FINAL  
IP65 ACLED - 241



PVPR 0,36€

Ref

Conector TIRA - CABLE  
1,5m P65 ACLED - 238



PVPR 8,31€



ACCESORIOS PARA **TLED-140-141-142-143-136-137-138-139**

Conector **TIRA-CABLE**  
Ref **ACLED - 502**  
PVPR **4,86€**



Conector **ESQUINA**  
**IP65** ACLED - 504  
Ref **ACLED - 503**  
PVPR **2,61€**



Conector **TIRA-TIRA**  
Ref **ACLED - 503**  
PVPR **1,86€**



Conector **TAPA FINAL**  
**IP65** ACLED - 505  
Ref **ACLED - 505**  
PVPR **0,36€**



ACCESORIOS **TIRA LED COB 24V**

**COB**

**IP 20**

Ref **ACLED - 227**  
**Conector fijo**  
tornillo Tira-Cable  
**IP20 10mm**



PVPR **2,22€**

Ref **ACLED - 226**  
**Conector fijo**  
tornillo Tira-Tira  
**2P 10mm IP20**



PVPR **2,22€**

Ref **ACLED - 228**  
**Conector fijo**  
tornillo Tira-Tira  
**"T&L" 2P 10mm**



PVPR **3,12€**

Ref **ACLED - 229**  
**Conector invisible**  
Tira-Tira "L"  
**2P 10mm IP20**



PVPR **1,62€**

Ref **ACLED - 223**  
**Conector rápido**  
COB Tira-Tira **IP20**  
c/cable **2P 10mm**



PVPR **5,22€**

Ref **ACLED - 162**  
**Conector rápido**  
tira COB Tira - Tira  
**10mm 5 uds**



PVPR **6,84€**

**IP 20**

Ref **ACLED - 208**  
**\* CON CABLE**  
**Conector**  
rápido LED  
TIRA-CABLE  
**2P 8MM IP20**



PVPR **2,70€**

Ref **ACLED - 207**  
**Conector**  
rápido LED COB  
TIRA-TIRA  
**2-PIN 8MM IP20 24v**



PVPR **1,98€**

Ref **ACLED - 210**  
**\* CON CABLE**  
**Conector**  
rápido LED  
TIRA-CABLE  
**2P 10MM IP20**



PVPR **2,70€**

Ref **ACLED - 209**  
**Conector**  
rápido LED COB  
TIRA-TIRA  
**2-PIN 10MM IP20 24v**



PVPR **1,98€**

Sellar juntas con silicona para una mayor protección.

**IP 68**

Ref **ACLED - 211**  
**Conector rápido LED**  
COB TIRA-TIRA  
**2-PIN 8MM IP68**  
**24V**



PVPR **4,38€**

Ref **ACLED - 213**  
**Conector rápido LED**  
COB TIRA-TIRA  
**2-PIN 10MM**  
**IP68 24V**

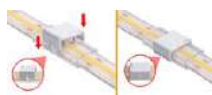

PVPR **4,62€**

Ref **ACLED - 212**  
**Conector \* CON CABLE**  
rápido LED COB  
TIRA-CABLE Con cable  
**2-PIN 8MM IP68**  
**24V**

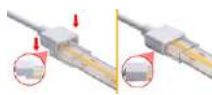

PVPR **4,98€**

Ref **ACLED - 214**  
**Conector \* CON CABLE**  
rápido LED COB  
TIRA-CABLE Con cable  
**2-PIN 10MM IP68**  
**24V**



PVPR **5,22€**

ACCESORIOS PARA **TLED 130 - 131 - 132 - 133**

**IP 65**

Ref **ACLED - 502**  
**Conector Cob**  
Tira-Cable  
**300mm - IP65**



PVPR **4,86€**

Ref **ACLED - 158**  
**Tapa final para**  
Tira led - **IP65**



PVPR **0,54€**

Ref **ACLED - 503**  
**Conector Cob**  
Tira-Tira recto  
**10mm - IP65**



PVPR **1,86€**

Ref **ACLED - 504**  
**Conector Cob**  
Tira-Tira esquina  
**10mm - IP65**



PVPR **2,61€**





ACCESORIOS TIRA LED SLIM COB 24V

SLIM COB 

ACCESORIOS PARA TLED-134-200

 **ACLED - 252**  
**CONECTOR TIRA-CABLE**  
 2PIN - IP20 - 4mm  
 PVPR 1,05€

 **ACLED - 253**  
**CONECTOR TIRA-TIRA**  
 2PIN - IP20 - 4mm  
 PVPR 0,36€

 **ACLED - 254**  
**CONECTOR TIRA-TIRA con cable**  
 2PIN - IP20 - 4mm  
 PVPR 1,38€

ACCESORIOS PARA TLED-201-202

 **ACLED - 264**  
**CONECTOR TIRA-CABLE**  
 2PIN - IP20 - 3mm

 **ACLED - 265**  
**CONECTOR TIRA-TIRA**  
 2PIN - IP20 - 3mm

 **ACLED - 266**  
**CONECTOR TIRA-TIRA con cable**  
 2PIN - IP20 - 3mm

ACCESORIOS TIRA LED COB 24V

FREE CUT COB 

ACCESORIOS PARA TLED-174-175-176-177-144 - 145 - 146 - 147

  **ACLED - 233**  
**CONECTOR TIRA-CABLE**  
 IP20  
 PVPR 1,04€

 **ACLED - 234**  
**CONECTOR TIRA-TIRA**  
 IP20  
 PVPR 0,36€

 **ACLED - 235**  
**CONECTOR TIRA-TIRA CABLE - IP20**  
 PVPR 1,39€

 **ACLED - 236**  
**CONECTOR FORMA "T-L" IP20**  
 PVPR 1,74€

ACCESORIOS PARA TLED 136 - 137 - 138 - 139 - 140 - 141 - 142 - 143

  **ACLED - 502**  
**CONECTOR TIRA-CABLE**  
 IP65  
 PVPR 4,86€

 **ACLED - 503**  
**CONECTOR TIRA-TIRA**  
 IP65  
 PVPR 1,86€



 **ACLED - 504**  
**CONECTOR ESQUINA**  
 IP65  
 PVPR 2,61€

 **ACLED - 505**  
**CONECTOR TAPA FINAL**  
 IP65  
 PVPR 0,36€

ACCESORIOS TIRA LED COB 24V

COB RGB  

ACCESORIOS PARA TLED 117-156

  **ACLED - 242**  
**Conector TIRA - CABLE RGB**  
 IP20 - 10mm  
 PVPR 1,05€

 **ACLED - 230**  
**Conector invisible Tira-Tira Recto**  
 4P 10mm IP20  
 PVPR 1,80€



 **ACLED - 243**  
**Conector TIRA - TIRA RGB**  
 IP20 - 10mm  
 PVPR 0,36€

 **ACLED - 244**  
**Conector TIRA - TIRA con cable RGB - IP20 - 10mm**  
 PVPR 1,38€

 **ACLED - 225**  
**Conector rápido RGB Tira-Cable IP20**  
 c/cable 4P 10mm  
 PVPR 4,56€

 **ACLED - 224**  
**Conector rápido RGB Tira-Tira IP20**  
 c/cable 4P 10mm  
 PVPR 7,32€

ACCESORIOS PARA TLED 118-157

  **ACLED - 245**  
**Conector TIRA - CABLE con cable RGB - IP65**  
 PVPR 3,48€

 **ACLED - 246**  
**Conector TIRA - TIRA RGB - IP65**  
 PVPR 1,74€

 **ACLED - 247**  
**Conector TIRA - TIRA con cable RGB - IP65**  
 PVPR 5,52€



ACCESORIOS TIRA LED DIGITAL 24V

DIGITAL



ACCESORIOS PARA TLED-170-171

COB DIGITAL



ACLED - 516  
CONECTOR TIRA-TIRA COB  
3P IP20

PVPR 0,36€



ACLED - 517  
CONECTOR TIRA-CABLE  
3P IP20

PVPR 1,04€



ACLED - 518  
CONECTOR TIRA-TIRA CABLE  
3P IP20

PVPR 1,38€

ACCESORIOS PARA TLED-135

SMD DIGITAL



ACLED - 249  
CONECTOR TIRA-CABLE  
4PIN - IP64 - 10mm

PVPR 3,72€



ACLED - 250  
CONECTOR TIRA-TIRA  
4PIN - IP64 - 10mm

PVPR 1,86€



ACLED - 251  
CONECTOR TIRA-TIRA con cable  
4PIN - IP64 - 10mm

PVPR 5,91€

CONECTOR TIRA LED MONOCOLOR



SMD



Ref

ACLED - 058  
Conector  
Tira-Tira IP20  
Monocolor 8mm

ACLED - 054  
Conector  
Tira-Tira IP20  
Monocolor 10mm

ACLED - 059  
Conector  
Tira-Cable IP20  
Monocolor 8mm

ACLED - 055  
Conector  
Tira-Cable IP20  
Monocolor 10mm

ACLED - 231  
Conector rápido  
Tira-Cable IP20  
Monocolor 10mm

ACLED - 060  
Conector cable  
2 hilos "I"

ACLED - 061  
Conector cable  
2 hilos "T"

PVPR

1,62€

1,83€

1,62€

1,83€

1,62€

2,61€

2,79€



Ref

ACLED-111  
Conector rápido  
Tira-Cable 10mm  
monocolor IP68

ACLED-112  
Conector rápido  
Tira-Tira Cable 10mm  
monocolor IP68

ACLED-113  
Conector rápido  
Tira-Tira 10mm  
monocolor IP68

PVPR

3,18€

4,56€

3,48€

CONECTOR TIRA LED 3CCT



SMD



ACCESORIOS PARA TLED 037

Ref ACLED-267  
Conector rápido  
TIRA - TIRA con cable  
IP20

TLED-037

Ref ACLED-268  
Conector rápido  
TIRA - CABLE  
IP20

TLED-037

Ref ACLED-269  
Conector rápido  
TIRA - TIRA  
IP20

TLED-037

PVPR

3,27€

4,71€

3,54€

ACCESORIOS PARA TLED 038

Ref ACLED-114  
Conector rápido  
Tira-Cable 10mm  
3CCT IP68

TLED-038

Ref ACLED-115  
Conector rápido  
Tira-Tira Cable  
10mm 3CCT IP68

TLED-038

Ref ACLED-116  
Conector rápido  
Tira-Tira 10mm  
3CCT IP68

TLED-038

PVPR

3,27€

4,71€

3,54€

\* Según la nueva normativa ERP ha habido un cambio en la medición de Lúmenes y vatios, pero sigue emitiendo la misma cantidad de luz.

A medida que vayan entrando los nuevos modelos con ERP se irá actualizando en catálogo y cajas de color.

Puede haber variación respecto a la caja del producto (comprobar en ficha técnica), todos los datos en catálogo están correctos salvo error tipográfico.



ACCESORIOS - TIRAS DE LED 24V

SMD



UNIÓN SOLDABLE TIRA LED MONOCOLOR

MONO  
COLOR



Ref

PVPR

UNIÓN SOLDABLE TIRA DE LED MONOCOLOR "L"	ACLED-019	1,20€
UNIÓN SOLDABLE TIRA DE LED MONOCOLOR "T"	ACLED-017	1,20€
UNIÓN SOLDABLE TIRA DE LED MONOCOLOR "X"	ACLED-015	1,20€



UNIÓN SOLDABLE TIRA LED RGB

RGB



UNIÓN SOLDABLE TIRA DE LED RGB "L"	ACLED-020	1,20€
UNIÓN SOLDABLE TIRA DE LED RGB "T"	ACLED-018	1,20€
UNIÓN SOLDABLE TIRA DE LED RGB "X"	ACLED-016	1,20€

CONECTOR TIRA LED RGB

RGB

SMD



IP  
20



ACCESORIOS PARA TLED 010 - 061



Ref ACLED - 056  
Conector  
Tira-Tira IP20  
RGB 10mm

ACLED - 057  
Conector  
Tira-Cable IP20  
RGB 10mm

PVPR 2,16€

2,16€



IP  
68



ACCESORIOS PARA TLED 006 - 047



ACLED-117  
Conector rápido  
Tira-Cable 10mm  
RGB IP68

ACLED-118  
Conector rápido  
Tira-Tira Cable 10mm  
RGB IP68

ACLED-119  
Conector rápido  
Tira-Tira 10mm  
RGB IP68

ACLED - 205  
Conector rápido LED  
TIRA-CABLE  
4-PIN 10MM RGB IP66

ACLED - 206  
Conector rápido LED  
TIRA-TIRA  
4-PIN 10MM RGB IP66

3,33€

4,77€

3,75€

3,06€

3,06€



Ref	ACLED - 001 <i>Grapa de plástico para Tira de LED IP67</i>	ACLED - 002 <i>Tapa final para Tira de LED IP67</i>	ACLED - 105 <i>Tubo termorretractil transparente Ø15mm - 1mts.</i>	ACLED - 467 <i>Tubo termorretractil negro Ø15mm - 1mts.</i>
PVPR	0,39€	0,39€	17,70€	17,70€

### CABLES



Ref	ACLED - 062 <i>Cable 2 hilos 0.52 para conexiones LED</i>	ACLED - 063 <i>Cable 4 hilos 0.34 para conexiones LED</i>	ACLED - 064 <i>Cable 5 hilos 0.34 para conexiones LED</i>	ACLED - 215 <i>Cable 6 HILOS 0.34 Para conexiones led 15cm</i>	ACLED - 156 <i>Cable alimentación DC hembra 5,5 blanco</i>	ACLED - 157 <i>Cable alimentación DC macho 5,5 blanco</i>
PVPR	0,45€	0,60€	0,87€	1,38€	1,59€	1,59€





*Serie* **Proyector exterior**

---



# PROYECTOR MINI DE ALTA POTENCIA LUMÍNICA

## MINI SLIM

Used **SAMSUNG** LED Chips

DIMMABLE

**3 en 1 TRES TIPOS DE LUZ EN LA MISMA LUMINARIA**

CÁLIDA NEUTRA FRÍA



## CAMBIO DE COLOR DE LUZ CON CONTROL REMOTO

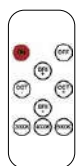

MANDO INCLUIDO

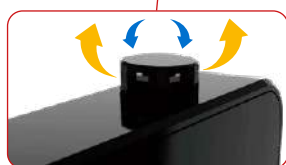

### Válvula anticondensación

Equilibra la diferencia de presión de aire entre el interior y el exterior de la lámpara para evitar la condensación.

PROYECTOR SMD BLACKBODY MANDO y MEMORIA.  
**50W 3CCT IP65 PRY-141 - 67,32€**



PRY-141

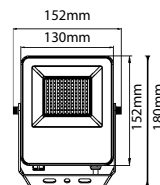

PROYECTOR SMD BLACKBODY MANDO y MEMORIA.  
**100W 3CCT IP65 PRY-142 - 113,40€**



PRY-142

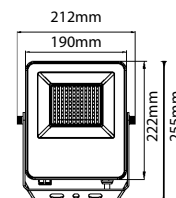

**NEW!**



LENTES PRISMÁTICAS

**ALTA**  
LUMINOSIDAD

**185**  
Lm/w

**High Efficiency**  
185Lm/w

**500 W** **PROYECTOR EXTERIOR**  
**DE ALTA POTENCIA LUMÍNICA**

*Ideal para iluminar grandes espacios*

Used **SAMSUNG** LED Chips **LIFUD** Led Driver

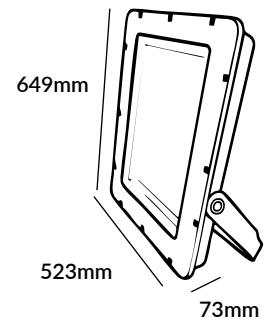

PROYECTOR EXTERIOR LED	NEW!	500W IP65	K°	Ref	PVPR
			5000K	PRY-447	669,45€

- 500 W
- 80000 Lm
- 230 V
- 1
- 120°
- IP 65
- >0,9 FP
- ↓

PROYECTOR EXTERIOR **Alta luminosidad LUMILEDS**



**300 W** **ALTA** LUMINOSIDAD **185** Lm/w **High Efficiency** 185Lm/w

PROYECTOR EXTERIOR LED	300W IP65	K°	Ref	PVPR
		4200K	PRY-445	249,18€
		5000K	PRY-446	249,18€

- 300 W
- 55500 Lm
- 230 V
- 4
- 120°
- IP 65
- >0,9 FP
- ↓

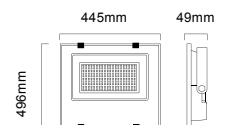

\* Según la nueva normativa ERP ha habido un cambio en la medición de Lúmenes y vatios, pero sigue emitiendo la misma cantidad de luz. A medida que vayan entrando los nuevos modelos con ERP se irá actualizando en catálogo y cajas de color. Puede haber variación respecto a la caja del producto (comprobar en ficha técnica), todos los datos en catálogo están correctos salvo error tipográfico.



PROYECTOR EXTERIOR *Alta luminosidad*

ALTA LUMINOSIDAD

160 Lm/w

High Efficiency 160Lm/w

ROTACIÓN 360°



			K°	Ref	PVPR
PROYECTOR EXTERIOR	30W IP65	NEW!	3200K	PRY-439	42,90€
PROYECTOR EXTERIOR	30W IP65		4200K	PRY-124	42,90€
PROYECTOR EXTERIOR	30W IP65		5000K	PRY-106	42,90€

30 W 4800 Lm 230 V 20 120° IP 65 >0,9 FP

OSRAM LED Chips

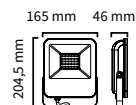

PROYECTOR EXTERIOR	50W IP65		3200K	PRY-125	66,72€
PROYECTOR EXTERIOR	50W IP65		4200K	PRY-126	66,72€
PROYECTOR EXTERIOR	50W IP65		5000K	PRY-107	66,72€

50 W 8000 Lm 230 V 10 120° IP 65 >0,9 FP

OSRAM LED Chips

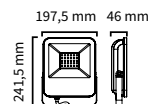

PROYECTOR EXTERIOR	100W IP65	NEW!	3200K	PRY-418	108,57€
PROYECTOR EXTERIOR	100W IP65		5000K	PRY-108	108,57€

100 W 16000 Lm 230 V 4 120° IP 65 >0,9 FP

OSRAM LED Chips

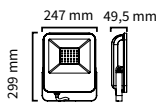

PROYECTOR EXTERIOR	150W IP65	NEW!	3200K	PRY-416	178,77€
PROYECTOR EXTERIOR	150W IP65		4200K	PRY-128	178,77€

150 W 24000 Lm 230 V 2 120° IP 65 >0,9 FP

OSRAM LED Chips

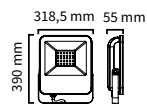

PROYECTOR EXTERIOR	200W IP65	NEW!	3200K	PRY-417	243,09€
PROYECTOR EXTERIOR	200W IP65		4200K	PRY-129	243,09€

200 W 30000 Lm 230 V 2 120° IP 65 >0,9 FP

OSRAM LED Chips

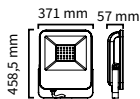

GRAN EFICIENCIA  
LUMÍNICA

GRAN  
LUMINOSIDAD

High Efficiency  
185LM/W



Proyector exterior  
**ALTA LUMINOSIDAD**

NEW!



High Efficiency  
185Lm/w

CHIP ALTA CALIDAD Lit by LUMILEDS



PROYECTOR EXTERIOR LED	NEW!	100W IP65	K°	Ref	PVPR
			4500K	PRY-441	86,04€

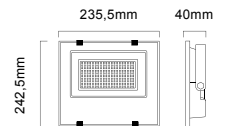

PROYECTOR EXTERIOR LED	NEW!	150W IP65	K°	Ref	PVPR
			5000K	PRY-443	132,06€

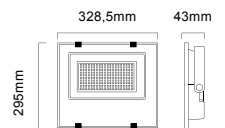

PROYECTOR EXTERIOR LED	NEW!	200W IP65	K°	Ref	PVPR
			5000K	PRY-444	173,70€

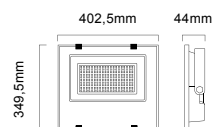

\* Según la nueva normativa ERP ha habido un cambio en la medición de Lúmenes y vatios, pero sigue emitiendo la misma cantidad de luz. A medida que vayan entrando los nuevos modelos con ERP se irá actualizando en catálogo y cajas de color. Puede haber variación respecto la caja del producto (comprobar en ficha técnica), todos los datos en catálogo están correctos salvo error tipográfico.



# Proyector exterior MINI

ROTACIÓN 140°



		K°	Ref	PVPR
PROYECTOR EXTERIOR MINI	10W IP67	3200K	PRY-133	15,72€
PROYECTOR EXTERIOR MINI	10W IP67	4200K	PRY-134	15,72€
PROYECTOR EXTERIOR MINI	10W IP67	5000K	PRY-117	15,72€



OSRAM LED Chips

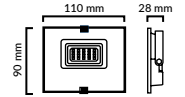

PROYECTOR EXTERIOR MINI	20W IP67	3200K	PRY-135	22,02€
PROYECTOR EXTERIOR MINI	20W IP67	4200K	PRY-136	22,02€
PROYECTOR EXTERIOR MINI	20W IP67	5000K	PRY-118	22,02€



OSRAM LED Chips

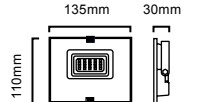

PROYECTOR EXTERIOR MINI	30W IP67	3200K	PRY-400	29,64€
PROYECTOR EXTERIOR MINI	30W IP67	4200K	PRY-399	29,64€
PROYECTOR EXTERIOR MINI	30W IP67	5000K	PRY-119	29,64€



OSRAM LED Chips

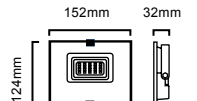

PROYECTOR EXTERIOR MINI	50W IP67	3200K	PRY-402	42,09€
PROYECTOR EXTERIOR MINI	50W IP67	4200K	PRY-401	42,09€
PROYECTOR EXTERIOR MINI	50W IP67	5000K	PRY-120	42,09€



OSRAM LED Chips

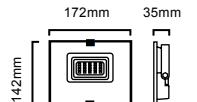

PROYECTOR EXTERIOR MINI	100W IP67	5000K	PRY-121	68,52€
-------------------------	-----------	-------	---------	--------



OSRAM LED Chips

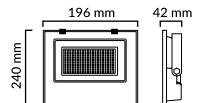

NEW!



PROYECTOR EXTERIOR MINI	150W IP67	5000K	PRY-405	105,75€
-------------------------	-----------	-------	---------	---------



OSRAM LED Chips

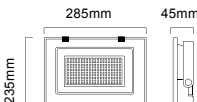

NEW!



PROYECTOR EXTERIOR MINI	200W IP67	5000K	PRY-406	132,39€
-------------------------	-----------	-------	---------	---------



OSRAM LED Chips

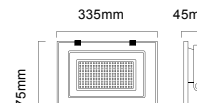

## PROYECTOR EXTERIOR MINI CON SENSOR DE MOVIMIENTO

ROTACIÓN 140°



PROYECTOR EXTERIOR MINI	50W IP65	3200K	PRY-404	57,93€
PROYECTOR EXTERIOR MINI	50W IP65	4200K	PRY-403	57,93€
PROYECTOR EXTERIOR MINI	50W IP65	5000K	PRY-130	57,93€



OSRAM LED Chips

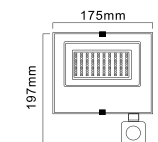

PROYECTOR EXTERIOR MINI	100W IP65	5000K	PRY-131	84,33€
-------------------------	-----------	-------	---------	--------



OSRAM LED Chips

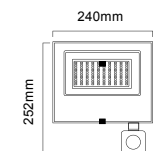



PROYECTOR EXTERIOR **ULTRASLIM**



ROTACIÓN  
270°

K°	Ref	PVPR
4200K	PRY-074	17,91€

PROYECTOR EXTERIOR **10W IP67**

10 W 1000 Lm 230 V 40 120° IP 67 >0,9 FP

OSRAM LED Chips

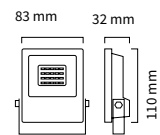

K°	Ref	PVPR
5000K	PRY-084	65,01€

PROYECTOR EXTERIOR **50W IP67**

50 W 5000 Lm 230 V 10 120° IP 67 >0,9 FP

OSRAM LED Chips

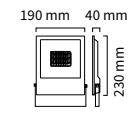

K°	Ref	PVPR
5000K	PRY-066	119,85€

PROYECTOR EXTERIOR **150W IP67**

150 W 15000 Lm 230 V 3 120° IP 67 >0,9 FP

OSRAM LED Chips

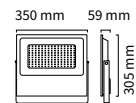

K°	Ref	PVPR
3200K	PRY-067	321,36€

PROYECTOR EXTERIOR **200W IP67**

200 W 20000 Lm 230 V 3 120° IP 67 >0,9 FP

OSRAM LED Chips

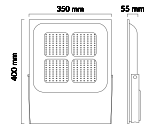

PROYECTOR EXTERIOR **LUMILEDS BLANCO**



ROTACIÓN  
270°

K°	Ref	PVPR
3200K	PRY-085	17,91€
4200K	PRY-086	17,91€
5000K	PRY-087	17,91€

PROYECTOR EXTERIOR LUMILEDS BLANCO **10W IP66**

10 W 900 Lm 230 V 20 120° IP 65 >0,9 FP

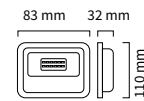

K°	Ref	PVPR
3200K	PRY-088	28,71€
4200K	PRY-089	28,71€
5000K	PRY-070	28,71€

PROYECTOR EXTERIOR LUMILEDS BLANCO **20W IP66**

20 W 1850 Lm 230 V 20 120° IP 65 >0,9 FP

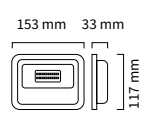

K°	Ref	PVPR
3200K	PRY-090	43,17€
4200K	PRY-091	43,17€
5000K	PRY-071	43,17€

PROYECTOR EXTERIOR LUMILEDS BLANCO **30W IP66**

30 W 2700 Lm 230 V 10 120° IP 65 >0,9 FP

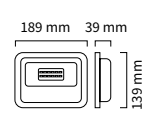

K°	Ref	PVPR
3200K	PRY-092	64,83€
4200K	PRY-093	64,83€
5000K	PRY-072	64,83€

PROYECTOR EXTERIOR LUMILEDS BLANCO **50W IP66**

50 W 4500 Lm 230 V 10 120° IP 65 >0,9 FP

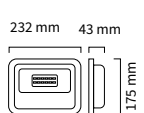

\* Según la nueva normativa ERP ha habido un cambio en la medición de Lúmenes y vatios, pero sigue emitiendo la misma cantidad de luz. A medida que vayan entrando los nuevos modelos con ERP se irá actualizando en catálogo y cajas de color. Puede haber variación respecto a la caja del producto (comprobar en ficha técnica), todos los datos en catálogo están correctos salvo error tipográfico.



**SERIE CLASSIC**

Used  
**OSRAM**  
LED Chips

**Eficiencia**  
110Lm/w



		K°	Ref	PVPR				
PROYECTOR EXTERIOR	<b>20W IP66</b>	5000K	● PRY-148	28,02€				
<b>20 W</b>	2200 Lm	230 V	20	120°	IP 66	>0,9 FP	↓	Used <b>OSRAM</b> LED Chips



PROYECTOR EXTERIOR	<b>30W IP66</b>	5000K	● PRY-149	34,74€				
<b>30 W</b>	3300 Lm	230 V	10	120°	IP 66	>0,9 FP	↓	Used <b>OSRAM</b> LED Chips



PROYECTOR EXTERIOR	<b>50W IP66</b>	5000K	● PRY-150	47,70€				
<b>50 W</b>	5500 Lm	230 V	10	120°	IP 66	>0,9 FP	↓	Used <b>OSRAM</b> LED Chips



PROYECTOR EXTERIOR	<b>100W IP66</b>	5000K	● PRY-151	84,30€				
<b>100 W</b>	11.000 Lm	230 V	5	120°	IP 66	>0,9 FP	↓	Used <b>OSRAM</b> LED Chips



# Proyector exterior RGB

PROYECTOR EXTERIOR RGB

MODO DE CONTROL CONTROLADOR RF 2.4Ghz



ROTACIÓN 270°

INCLUYE MANDO / CON MEMORIA / ROTACIÓN 270°

		K°	Ref	PVPR
PROYECTOR EXTERIOR RGB	30W 2500Lm IP66	RGB	PRY-099	79,47€
PROYECTOR EXTERIOR RGB	50W 4000Lm IP66	RGB	PRY-100	103,38€



PROYECTORES SINCRONIZADOS

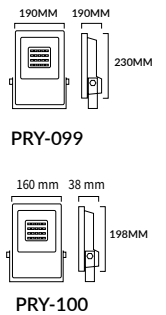

PRY-100



ROTACIÓN 360°

INCLUYE MANDO / CON MEMORIA / ROTACIÓN 360°

PROYECTOR EXTERIOR	20W - 800Lm - IP65	20	RGB 3CCT	PRY-113	35,40€	↓
PROYECTOR EXTERIOR	30W - 1200Lm - IP65	20	RGB 3CCT	PRY-114	49,14€	↓
PROYECTOR EXTERIOR	50W - 2000Lm - IP65	10	RGB 3CCT	PRY-115	57,06€	↓
PROYECTOR EXTERIOR	100W - 4000Lm - IP65	10	RGB 3CCT	PRY-116	92,43€	↓

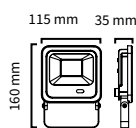

PRY-113

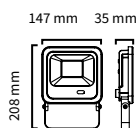

PRY-114

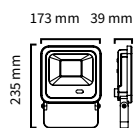

PRY-115

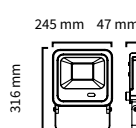

PRY-116

\* Según la nueva normativa ERP ha habido un cambio en la medición de Lúmenes y vatios, pero sigue emitiendo la misma cantidad de luz. A medida que vayan entrando los nuevos modelos con ERP se irá actualizando en catálogo y cajas de color. Puede haber variación respecto a la caja del producto (comprobar en ficha técnica), todos los datos en catálogo están correctos salvo error tipográfico.

# ILUMINA TU EXTERIOR

## Proyector exterior domótico

MODO DE CONTROL

CONTROLADOR RF 2.4Ghz y WiFi



CONTROL REMOTO + INCLUIDO

PROYECTOR EXTERIOR RGB + 3CCT TUYA

30W IP65

K° Ref PVPR

PRY-146 104,04€



tuya

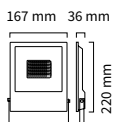

PROYECTOR EXTERIOR RGB + 3CCT TUYA

50W IP65

PRY-147 113,82€



tuya

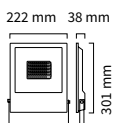

**2 MODOS DE CONTROL: WIFI + CONTROLADOR REMOTO - INCLUYE MANDO - CON MEMORIA**  
Para el funcionamiento del mando a distancia es necesario vincular primero el proyector a su conexión wifi.



CONTROL REMOTO + INCLUIDO

PROYECTOR EXTERIOR WIFI

10W - 750Lm - IP65

RGB 3CCT PRY-104 62,73€

PROYECTOR EXTERIOR WIFI

20W - 1600Lm - IP65

RGB 3CCT PRY-105 66,18€



tuya

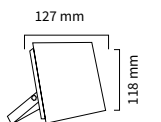

# Accesorios

## SOPORTE PICA 17 CM PARA PROYECTOR WIFI

Ref PVPR

PICA 17 CM	PARA PROYECTOR WIFI PRY-104	10w	ACLED-122	4,95€
PICA 17 CM	PARA PROYECTOR WIFI PRY-116	100w	ACLED-125	14,94€



PICA JARDIN 16 CM	UNIVERSAL - 2 UNIDADES		ACLED-217	2,34€
-------------------	------------------------	--	-----------	-------

### Sensor de movimiento HF 5.8GHz para proyector 100w



Radio 5-10mts. - 25-2000 LUX - 5 Seg.-20 Min.

ACLED-088 24,54€

### Sensor de movimiento Infrarrojo para proyector



Radio 5-10mts. - 3-2000 LUX - 10 Seg.-7 Min.

ACLED-087 14,10€

### Soporte Kit Sensor



Compatible con los proyectores OSRAM : 20w, 30w, 50w y 100w de Atmos

Incluye conector, lira y tornillería

ACLED-098 Para proyector 20W	ACLED-099 Para proyector 30W	ACLED-100 Para proyector 50W	ACLED-101 Para proyector 100W
20,10€	20,10€	25,23€	25,23€

### Protector sobretensión transitorio para LED SPD-20-240P



Protege sobretensiones de hasta 20kA



AXLED - 011 54€

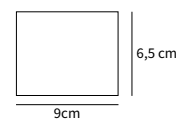

### Conector de cable Estanco



Para proyector "I"

ACLED -044 8,67€

### Conector de cable Estanco



Para proyector "T"

ACLED - 079 15,90€

### Soporte brazo para proyector Exterior



Máx. 100W - 80cm

ACLED-025 56,70€



*Serie* **Gama Solar**



Ángulo ajustable  
90°

### ¿Te imaginas no depender nunca más de la red eléctrica?

Con la iluminación solar, eso es posible. Es como decirle adiós a las facturas interminables y a los cortes de luz.

Instalas las luces donde quieras, sin preocuparte por cables, permisos complicados o tarifas que suben cada año. Solo necesitas el sol, y el resto funciona solo.

Puedes ahorrar hasta un 80% en costes de energía.

Es simple: menos líos, más ahorro, y una libertad que no tiene precio.

Piensa en todo lo que podrías hacer con ese dinero que ya no gastas en luz.

La iluminación solar es ese cambio que te da tranquilidad y te pone por delante.

### ¿Te animas a probar?



Conoce la nueva gama en  
**ILUMINACIÓN SOLAR**

# Serie Farolas Solar

**NEW!**



Disponible control remoto



**GRAN AUTONOMÍA**  
3.2V 1500mAh

**SERIE ALUMINIO**

FAROLA LED SOLAR 63MM DIAM C/MANDO	1800Lm LED IP65	3200K	FRL-056	185,40€
FAROLA LED SOLAR 63MM DIAM C/MANDO	1800Lm LED IP65	4200K	FRL-048	185,40€
FAROLA LED SOLAR 63MM DIAM C/MANDO	1800Lm LED IP65	5000K	FRL-049	185,40€



Altura de instalación recomendada: 4m máx



Rango detección: 3m máx

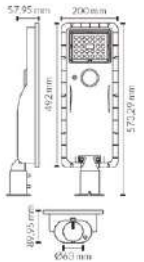

Disponible control remoto



**GRAN AUTONOMÍA**  
3.2V 2000mAh

**SERIE ALUMINIO**

FAROLA LED SOLAR 63MM DIAM C/MANDO	2600Lm LED IP65	3200K	FRL-057	224,55€
FAROLA LED SOLAR 63MM DIAM C/MANDO	2600Lm LED IP65	4200K	FRL-050	224,55€
FAROLA LED SOLAR 63MM DIAM C/MANDO	2600Lm LED IP65	5000K	FRL-051	224,55€



Altura de instalación recomendada: 4m máx

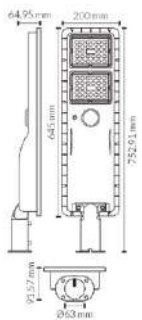

Disponible control remoto



**GRAN AUTONOMÍA**  
3.2V 3000mAh

**SERIE ALUMINIO**

FAROLA LED SOLAR 63MM DIAM C/MANDO	3400Lm LED IP65	3200K	FRL-058	289,08€
FAROLA LED SOLAR 63MM DIAM C/MANDO	3400Lm LED IP65	4200K	FRL-052	289,08€
FAROLA LED SOLAR 63MM DIAM C/MANDO	3400Lm LED IP65	5000K	FRL-053	289,08€



Altura de instalación recomendada: 4m máx

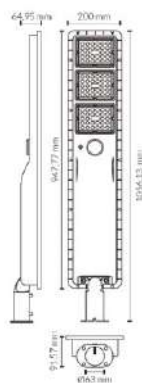

Ø 60mm

SOPORTE PARA FAROLA SOLAR FRL-048/058	GRIS	Ref	PVPR
		ACLED-493	12,30€



CARGA SOLAR



CONTROL INTELIGENTE DE LUZ



RESISTENTE AL AGUA



SENSOR PIR DE MOVIMIENTO



NEW!



GRAN AUTONOMÍA  
3.2V 1000mAh

FAROLA LED SOLAR 50MM DIAM C/MANDO

1100Lm LED IP65

K Ref PVPR  
5000K FRL-046 154,71€



Disponible control remoto



Altura de instalación recomendada: 4m máx

Rango detección: 4m máx

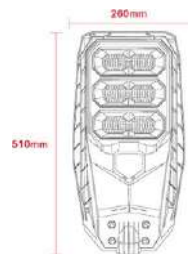

GRAN AUTONOMÍA  
3.2V 1800mAh

FAROLA LED SOLAR 50MM DIAM C/MANDO

2100Lm LED IP65

K Ref PVPR  
5000K FRL-047 225,60€



Disponible control remoto

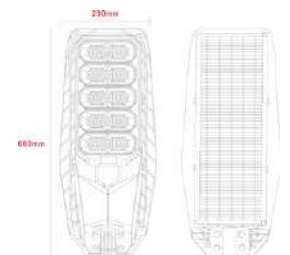

Ø BASE 50mm

SOPORTE PARA FAROLA SOLAR FRL-046/047

NEGRO

Ref PVPR  
ACLED-492 15,54€



**MODO DE CONTROL**  
CONTROLADOR RF 2.4Ghz



**GRAN AUTONOMÍA**  
3.2V 1800mAh



INCLUYE MANDO

\* ØBase 50mm Sensor de movimiento y crepuscular

FAROLA LED	1080Lm	Bateria LifeP04 18Ah/3.2V	K°	Ref	PVPR
			4200K	FRL-018	154,71€

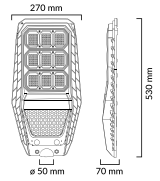

**GRAN AUTONOMÍA**  
3.2V 3000mAh



INCLUYE MANDO

\* ØBase 50mm Sensor de movimiento y crepuscular

FAROLA LED	2130Lm	Bateria LifeP04 30Ah/3.2V	4200K	FRL-020	225,60€
FAROLA LED	2130Lm	Bateria LifeP04 30Ah/3.2V	5000K	FRL-021	225,60€

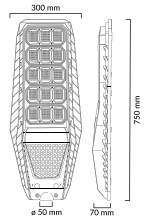

\* ØBase 50mm

FAROLA LED	2130Lm	Soporte para farola FRL-018 a FRL-021	NEGRO	ACLED-166	16,86€
------------	--------	---------------------------------------	-------	-----------	--------

**FAROLA SOLAR LED - PANEL SOLAR INTEGRADO**
  
 2630 LED Chip

  
**Battery**  
 Li-ion  
 LITHIUM

  
 SENSOR PIR  
 DE MOVIMIENTO

  
 SENSOR  
 CREPUSCULAR

**AUTONOMÍA**  
 3.2V 1000mAh

**MODO DE CONTROL**    CONTROLADOR RF 2.4Ghz 

 INCLUYE  
 MANDO

 Ø base 48mm - COMPATIBLE CON ACLED-102-103-104 -  
 SENSOR DE MOVIMIENTO Y CREPUSCULAR

				Kº	Ref	PVPR
FAROLA SOLAR LED	950Lm	Batería LifePO4 Litio 10Ah	4200K		FRL-012	156,87€
FAROLA SOLAR LED	950Lm	Batería LifePO4 Litio 10Ah	5000K		FRL-013	156,87€

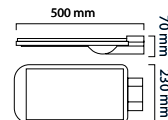
**AUTONOMÍA**  
 3.2V 1500mAh

 INCLUYE  
 MANDO

Ø base 48mm - COMPATIBLE CON ACLED-102-103-104 - SENSOR DE MOVIMIENTO Y CREPUSCULAR

FAROLA SOLAR LED	1900Lm	Batería LifePO4 Litio 15Ah	4200K		FRL-010	170,31€
FAROLA SOLAR LED	1900Lm	Batería LifePO4 Litio 15Ah	5000K		FRL-011	170,31€

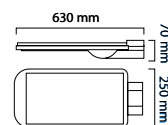

\* ØBase 5cm - 50cm

Soporte para farola FRL-010 a FRL-013	GRIS	ACLED-171	16,86€
---------------------------------------	------	-----------	--------

# Serie Farolas UFO Solar

MODO DE CONTROL CONTROLADOR RF 2.4Ghz



INCLUYE MANDO

COMPATIBLE CON MASTIL FRL-035



GRAN AUTONOMÍA  
3.2V 2000mAh

Ø base 80mm - SENSOR DE MOVIMIENTO Y CREPUSCULAR

FAROLA SOLAR LED UFO 900Lm Batería LifePO4 Litio 3.2V / 20Ah 3200K ● FRL-014 131,46€

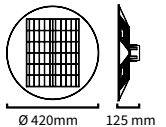

INCLUYE MANDO

NUEVO DISEÑO  
COMPATIBLE CON MASTIL FRL-035



GRAN AUTONOMÍA  
3.2V 2000mAh

Ø base 75mm - SENSOR DE MOVIMIENTO Y CREPUSCULAR

FAROLA SOLAR LED UFO 900Lm Batería LifePO4 Litio 3.2V/20Ah 3200K ● FRL-031 149,70€  
FAROLA SOLAR LED UFO 900Lm Batería LifePO4 Litio 3.2V/20Ah 5000K ● FRL-032 149,70€

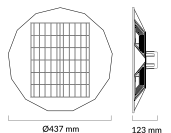

INCLUYE MANDO

NUEVO DISEÑO  
COMPATIBLE CON MASTIL FRL-035



GRAN AUTONOMÍA  
3.2V 2500mAh

Ø base 75mm - SENSOR DE MOVIMIENTO Y CREPUSCULAR

FAROLA SOLAR LED UFO 1400Lm Batería LifePO4 Litio 3.2V/25Ah 3200K ● FRL-033 201,30€

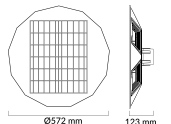

**NUEVO DISEÑO** | **NUEVA BATERÍA**



**NEW!**



Disponible control remoto

**INSTALACIÓN MÁXIMA 3 METROS**  
**COMPATIBLE CON MASTIL FRL-035**



**GRAN AUTONOMÍA**  
3.2V 2000mAh

Ø BASE 77mm - SENSOR DE MOVIMIENTO Y CREPUSCULAR

K° Ref PVPR

FAROLA LED SOLAR 50MM DIAM C/MANDO	1800Lm LED IP65	3200K	FRL-054	215,70€
FAROLA LED SOLAR 50MM DIAM C/MANDO	1800Lm LED IP65	5000K	FRL-055	215,70€



TEMPORIZADOR



CONTROL DE LUZ INTELIGENTE



MANDO A DISTANCIA



SENSOR DE MOVIMIENTO PIR



78mm

550mm

**INSTALACIÓN MÁXIMA 3 METROS**  
**COMPATIBLE CON MASTIL FRL-035**



**GRAN AUTONOMÍA**  
3.2V 1500mAh

Ø BASE 77mm - SENSOR DE MOVIMIENTO Y CREPUSCULAR

FAROLA LED SOLAR 50MM DIAM C/MANDO	1300Lm LED IP65	5000K	FRL-060	201,30€
------------------------------------	-----------------	-------	---------	---------



TEMPORIZADOR



CONTROL DE LUZ INTELIGENTE



MANDO A DISTANCIA



SENSOR DE MOVIMIENTO PIR

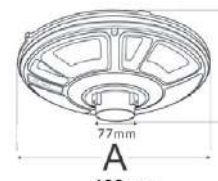

60mm

420mm



**NEW!**



Disponible control remoto



**COMPATIBLE SOLO PARA FAROLAS SOLAR UFO**

**FAROLA MASTIL 3 METROS PARA FRL NEW UFO CON AGARRE SUELO**

FRL-035 336,69€



- \* Farola UFO no incluida
- \* Disponible solo comprando nuestra Farola Solar UFO.
- \* Venta sin montaje.
- \* Pintado en color negro.

**Diametro final para farola Ø73mm**

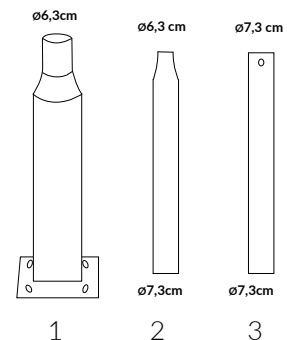

**Orden de colocación**



# Serie Proyector solar con panel externo

PROYECTOR SOLAR CON PANEL EXTERNO



MODO DE CONTROL  
CONTROLADOR RF 2.4Ghz



**BATERÍA**  
3.2V 500mAh

SENSOR CREPUSCULAR - INCLUYE MANDO

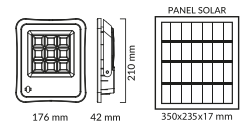

PROYECTOR SOLAR CON MANDO BATERÍA LifeP04 32650 3.2V 5Ah 5000K PRY-122 77,85€

**GRAN AUTONOMÍA**  
3.2V 2000mAh

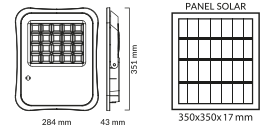

RADAR  
SENSOR

PROYECTOR SOLAR CON MANDO BATERÍA LifeP04 BYD 3.2V 20Ah 5000K PRY-123 113,85€

- 545 Lm
- 2010 Lm
- 1
- 90°
- IP 65
- SENSOR CREPUSCULAR



DESCARGAR INSTRUCCIONES

## NOTA IMPORTANTE PARA LA PUESTA EN MARCHA DEL PANEL

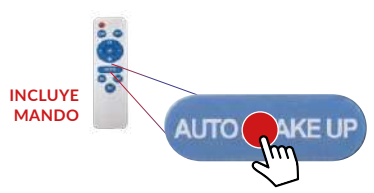

Para poder usar el proyector, hay que desbloquear el mando pulsando en medio, el botón "AUTO/WAKE UP".

El proyector está bloqueado debido a un sistema de protección para que la batería no se agote.



PROYECTOR SOLAR 3CCT CON PANEL EXTERNO

MODO DE CONTROL  
CONTROLADOR RF 2.4GHz



3 en 1 TRES TIPOS DE LUZ  
EN LA MISMA LUMINARIA



Switch  
3CCT



BATERÍA  
3.2V 2500mAh

ALUMINIO - SENSOR CREPUSCULAR

Panel solar (6V 20W) + proyector

PROYECTOR SOLAR CON MANDO

BATERÍA LifeP04 BYD 3.2V 25Ah

3CCT

PRY-132 107,85€

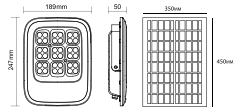

RADAR  
SENSOR INCLUYE  
MANDO



BATERÍA  
3.2V 4000mAh

ALUMINIO - SENSOR CREPUSCULAR

Panel solar (6V 40W) + proyector

PROYECTOR SOLAR CON MANDO

BATERÍA LifeP04 BYD 3.2V 40Ah

3CCT

PRY-137 141,90€

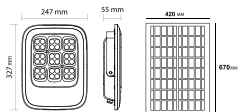

\* Según la nueva normativa ERP ha habido un cambio en la medición de Lúmenes y vatios, pero sigue emitiendo la misma cantidad de luz. A medida que vayan entrando los nuevos modelos con ERP se irá actualizando en catálogo y cajas de color. Puede haber variación respecto la caja del producto (comprobar en ficha técnica), todos los datos en catálogo están correctos salvo error tipográfico.



2 MODOS DE CONTROL



INCLUYE MANDO

## Proyector solar con cámara domótico

2 MODOS DE CONTROL

WIFI + CONTROLADOR RF 2.4Ghz



COMPATIBLE CON APP **tuya**



**GRAN AUTONOMÍA**  
3000mAh

SENSOR DE MOVIMIENTO Y CREPUSCULAR

PROYECTOR SOLAR CON CÁMARA 3000Lm Bateria Li-On 30Ah 6000K ● PRY-140 296,25€

Campo de detección: 5 - 8 metros Ángulo de detección: 200°

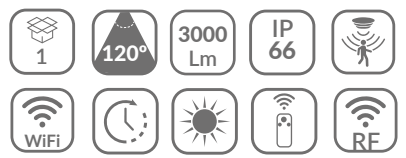

- Sensor de movimiento
- Cámara HD
- Sensor de luz
- Automaticamente se encienden las luces cuando detecta movimiento.



# Proyector solar de trabajo



LUZ EMERGENCIA



3 MODOS DE LUZ / LUZ EMERGENCIA

PROYECTOR SOLAR AMARILLO 3.7V 5000mAh Li-ion 6000K PRY-143 74,07€

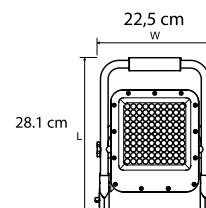

3 MODOS DE LUZ / LUZ EMERGENCIA

PROYECTOR SOLAR AMARILLO 3.7V 10.000mAh Li-ion 6000K PRY-144 106,20€

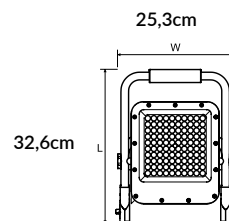

3 MODOS DE LUZ / LUZ EMERGENCIA

PROYECTOR SOLAR AMARILLO 3.7V 15.000mAh Li-ion 6000K PRY-145 143,67€

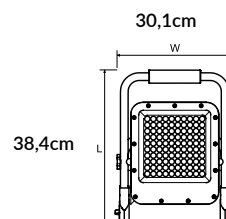

\* Según la nueva normativa ERP ha habido un cambio en la medición de Lúmenes y vatios, pero sigue emitiendo la misma cantidad de luz. A medida que vayan entrando los nuevos modelos con ERP se irá actualizando en catálogo y cajas de color. Puede haber variación respecto la caja del producto (comprobar en ficha técnica), todos los datos en catálogo están correctos salvo error tipográfico.



NEW PRICE!!



CAMPANA SOLAR CON PANEL EXTERNO

Battery  
Li-ion  
LITHIUM

MODO DE CONTROL  
CONTROLADOR RF 2.4Ghz

RADAR  
SENSOR

CAMPANA SOLAR	1800Lm 3.2V 25Ah IP65	K°	Ref	PVPR
		5000K	CMP-026	164,70 €



INCLUYE  
MANDO

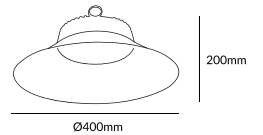



## Serie Apliques solares



ESPECIAL  
PUERTAS,  
FACHADAS Y  
LETREROS



GRAN  
AUTONOMÍA  
3.7V 2000mAh\*2

	K°	Ref	PVPR
APLIQUE SOLAR PARED	3200K	APQ-098	50,85€

1000  
Lm



120°

IP  
65

SENSOR PIR  
DE MOVIMIENTO

3 MODOS DE USO





**BATERÍA MEJORADA DE LARGA DURACIÓN**

K° Ref  
3CCT PRY-162

APLIQUE SOLAR PARED 3.7V 2500mAh Li-ion

1000 Lm 1 120° IP 65 SENSOR PIR DE MOVIMIENTO

3 MODOS DE USO



**NEW!**



**GRAN AUTONOMÍA**  
3.7V 2500mAh

**3 en 1 TRES TIPOS DE LUZ EN LA MISMA LUMINARIA**

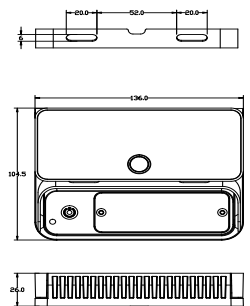

**BATERÍA MEJORADA DE LARGA DURACIÓN**

K° Ref  
3CCT PRY-163

APLIQUE SOLAR PARED 3.7V 2500mAh \* 2 Li-ion

1600 Lm 1 120° IP 65 SENSOR PIR DE MOVIMIENTO

3 MODOS DE USO



**NEW!**



**GRAN AUTONOMÍA**  
3.7V 2500mAh\*2

**3 en 1 TRES TIPOS DE LUZ EN LA MISMA LUMINARIA**

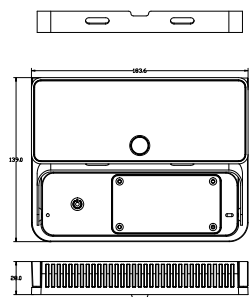

**RADAR SENSOR**

K° Ref PVPR  
5000K APQ-058 26,85€

APLIQUE SOLAR PARED CON RADAR SENSOR 3.7V 2600mAh Li-ion

350 Lm 120° IP 65 SENSOR RADAR DE MOVIMIENTO



**GRAN AUTONOMÍA**  
3.7V 2600mAh

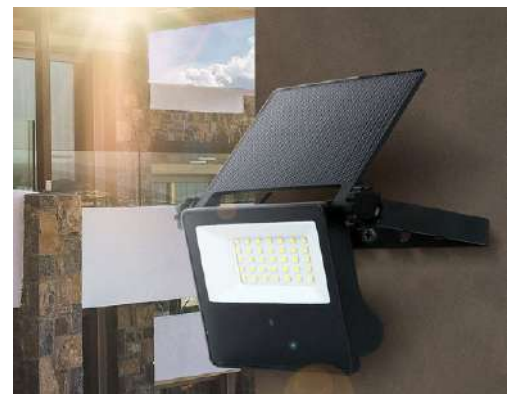
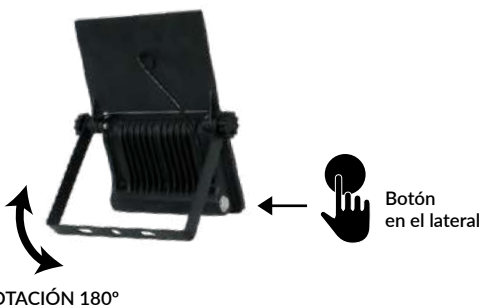



**NEW!**



**GRAN AUTONOMÍA**  
3.7V 1800mAh

APLIQUE SOLAR PARED	3.7V 1800mAh Li-ion	K°	Ref	PVPR
		3200K	APQ-095	22,80€

- 300 Lm
- 1
- 90°
- IP 65
- ↓

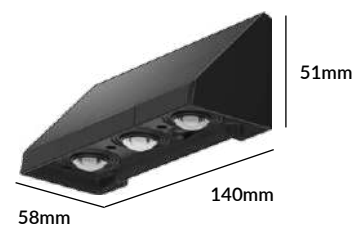

**NEW!**



**GRAN AUTONOMÍA**  
3.7V 1200mAh

APLIQUE SOLAR PARED	3.7V 1200mAh Li-ion	K°	Ref	PVPR
		3CCT	APQ-096	18€

- 200 Lm
- 1
- 90°
- IP 65
- ↓

**3 en 1 TRES TIPOS DE LUZ EN LA MISMA LUMINARIA**



\* Según la nueva normativa ERP ha habido un cambio en la medición de Lúmenes y vatios, pero sigue emitiendo la misma cantidad de luz. A medida que vayan entrando los nuevos modelos con ERP se irá actualizando en catálogo y cajas de color. Puede haber variación respecto la caja del producto (comprobar en ficha técnica), todos los datos en catálogo estan correctos salvo error tipográfico.

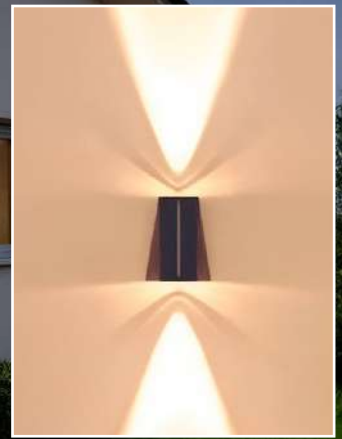

**NEW!**



APLIQUE SOLAR PARED 3.7V 1800mAh Li-ion K° 3200K Ref APQ-091 PVPR 26,85€

200 Lm
1
90°
IP 65
↓

**Battery**  
Li-ion  
LITHIUM

**GRAN AUTONOMÍA**  
3.7V 1800mAh

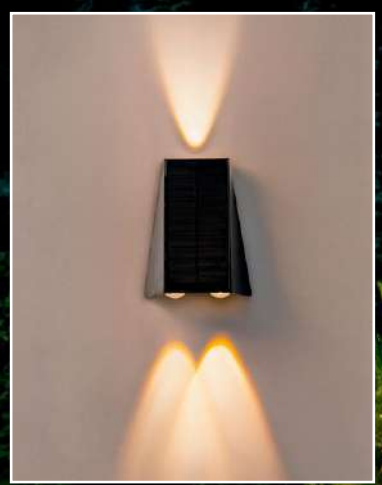

**NEW!**



APLIQUE SOLAR PARED 3.7V 1800mAh Li-ion K° 3200K Ref APQ-092 PVPR 28,50€

300 Lm
1
90°
IP 65
↓

**Battery**  
Li-ion  
LITHIUM

**GRAN AUTONOMÍA**  
3.7V 1800mAh



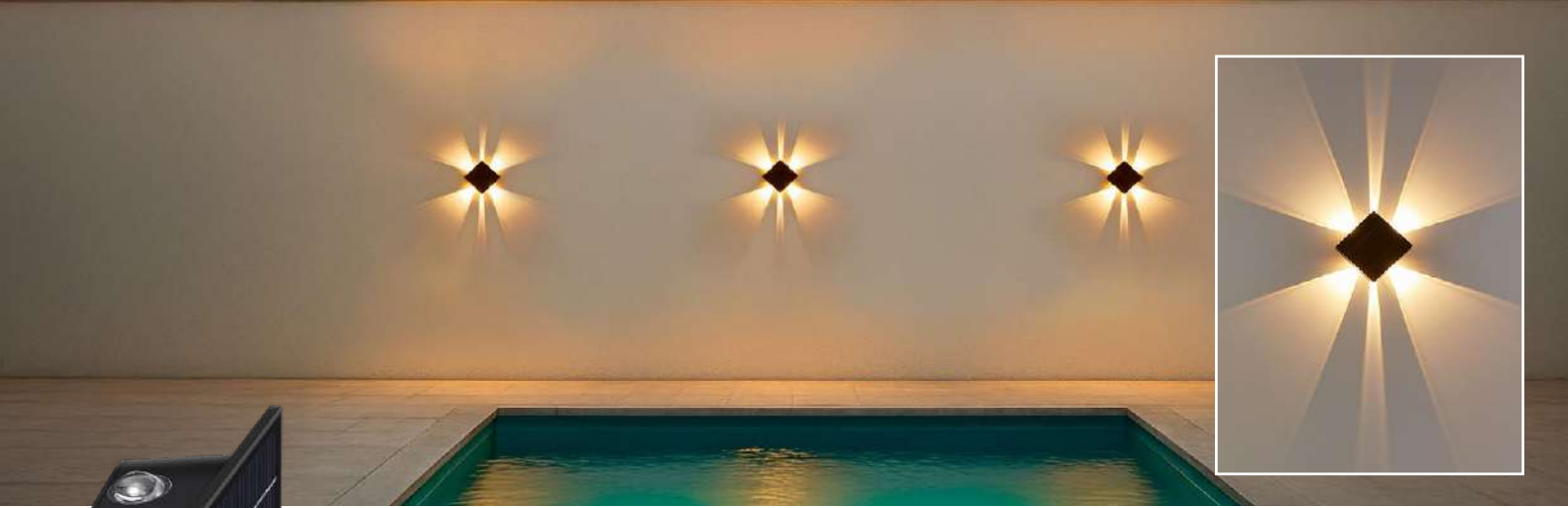

**NEW!**



APLIQUE SOLAR PARED

3.7V 1800mAh Li-ion

K°

3200K ●

Ref

APQ-089

PVPR

28,50€

200 Lm

1

90°

IP 65

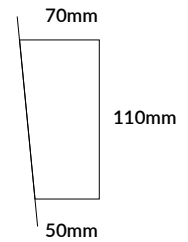
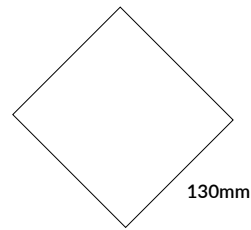

**GRAN AUTONOMÍA**  
3.7V 1800mAh



**NEW!**



APLIQUE SOLAR PARED

3.7V 1800mAh Li-ion

K°

3200K ●

Ref

APQ-090

PVPR

23,85€

200 Lm

1

90°

IP 65

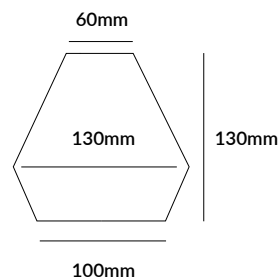

**GRAN AUTONOMÍA**  
3.7V 1800mAh

\* Según la nueva normativa ERP ha habido un cambio en la medición de Lúmenes y vatios, pero sigue emitiendo la misma cantidad de luz. A medida que vayan entrando los nuevos modelos con ERP se irá actualizando en catálogo y cajas de color. Puede haber variación respecto la caja del producto (comprobar en ficha técnica), todos los datos en catálogo están correctos salvo error tipográfico.

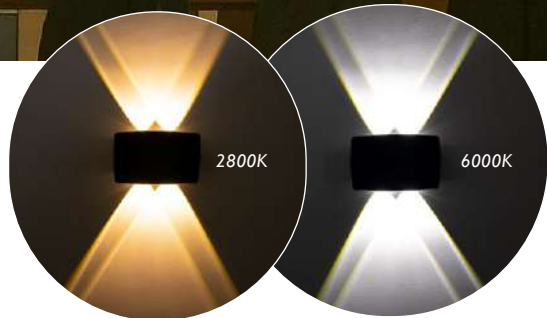
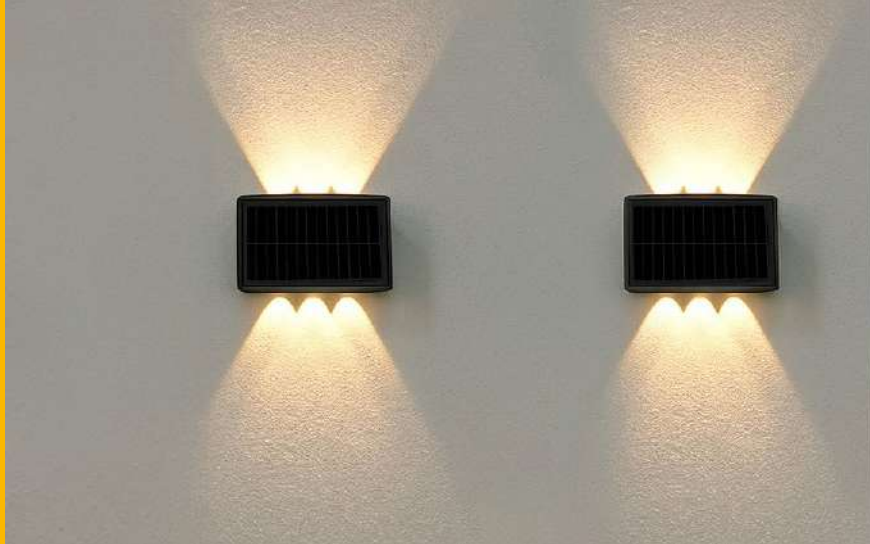

## APLIQUE LED SOLAR 4 y 6 LEDS



**2 EN 1** DUAL COLOR 4LEDS SMD5050  
2 COLORES EN 1

APLIQUE LED SOLAR 18650 3.7V 1800mAh 2800K 6000K APQ-055 26,85€



**GRAN AUTONOMÍA**  
3.7V 1800mAh

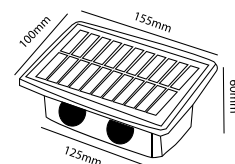

Botón en la parte trasera



**2 EN 1** DUAL COLOR 6LEDS SMD5050  
2 COLORES EN 1

APLIQUE LED SOLAR 18650 3.7V 2200mAh 2800K 6000K APQ-057 35,85€



**GRAN AUTONOMÍA**  
3.7V 2200mAh

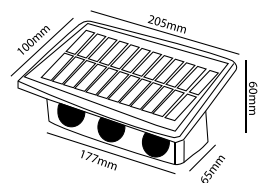

RGB 4LEDS SMD5050

APLIQUE LED SOLAR 18650 3.7V 1800mAh RGB APQ-056 26,85€



**GRAN AUTONOMÍA**  
3.7V 1800mAh

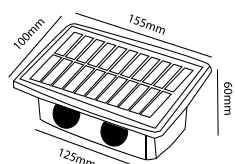

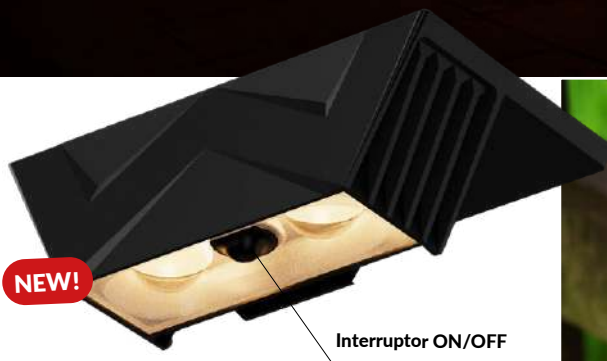
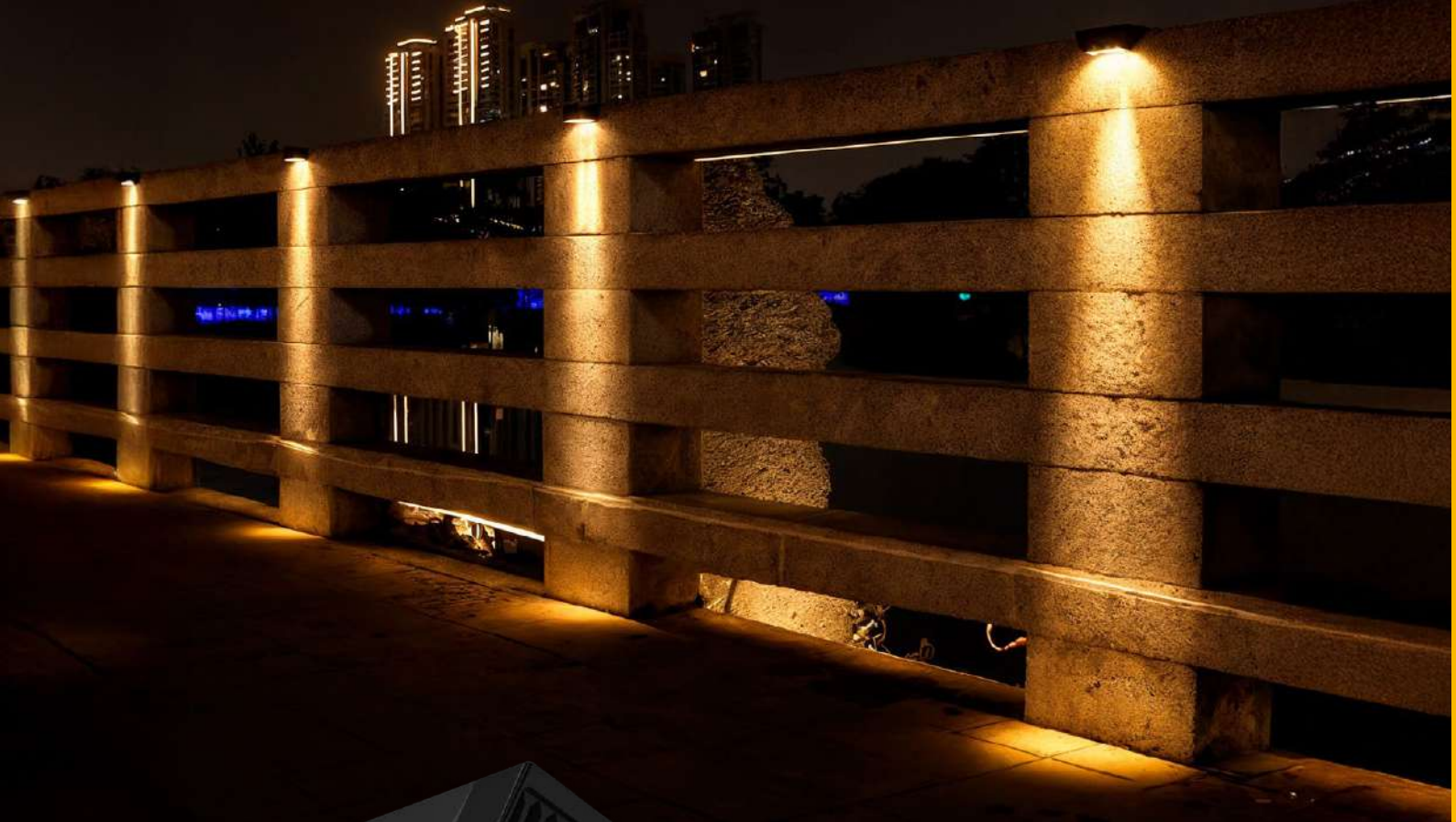

**2 Modos de instalación:** (Accesorios incluidos)

• Cinta adhesiva 3M

• Anclado con tornillo



APLIQUE SOLAR VALLA

3.2V 500mAh Li-ion

K° Ref PVPR

3200K ● APQ-099 19,05€

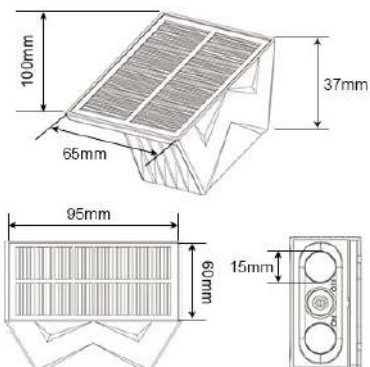

\* Según la nueva normativa ERP ha habido un cambio en la medición de Lúmenes y vatios, pero sigue emitiendo la misma cantidad de luz. A medida que vayan entrando los nuevos modelos con ERP se irá actualizando en catálogo y cajas de color. Puede haber variación respecto la caja del producto (comprobar en ficha técnica), todos los datos en catálogo están correctos salvo error tipográfico.



APLIQUE SOLAR PARED

3.7V 3600mAh Li-ion

K°

Ref

PVPR

3200K 

APQ-088

43,56€



### 4 MODOS

1° MODO - 100% LUZ

2° MODO - 30% LUZ

3° MODO - INTENSIDAD DE LUZ AUMENTA Y DISMINUYE DE FORMA AUTOMÁTICA

4° MODO - LUZ PARPADEANTE



**GRAN AUTONOMÍA**  
3.7V 3600mAh



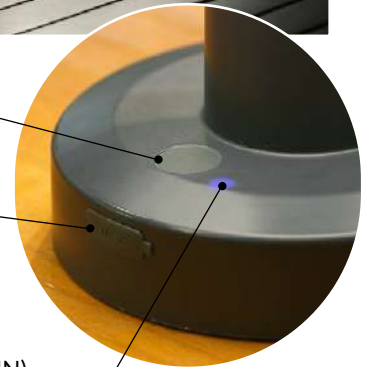

Botón ON/OFF

Carga USB Tipo-C

Led indicador Azul (Modo IN)



#### 4 MODOS DE LUZ

- 1ª 25%
- 2º 50%
- 3º 75%
- 4º 100%

Botón IN/OUT



#### 2 MODOS IN/OUT

##### IN - Modo interior:

Para uso en interiores, utilice un cable tipo C para conectar la alimentación de 5 V para cargar la batería e iluminar la lámpara. El sensor de luz no funciona en este modo: la lámpara no se enciende ni se apaga automáticamente. Para encenderla o apagarla, presione el interruptor ON/OFF. Modo IN, La luz indicadora IN se encenderá luz azul.

##### EX - Modo exterior:

Para uso en exteriores, el panel solar carga la batería. El sensor de luz funciona: La lámpara se apaga automáticamente durante el día y se enciende automáticamente por la noche. Ofrece una luz que dura desde el anochecer hasta el amanecer.

LÁMPARA DE MESA

3.7V 2200mAh Li-ion

K°  
4000K

Ref  
LMP-100

PVPR  
45,15€



18cm

15cm

\* Según la nueva normativa ERP ha habido un cambio en la medición de Lúmenes y vatios, pero sigue emitiendo la misma cantidad de luz. A medida que vayan entrando los nuevos modelos con ERP se irá actualizando en catálogo y cajas de color. Puede haber variación respecto a la caja del producto (comprobar en ficha técnica), todos los datos en catálogo están correctos salvo error tipográfico.



NEW!



**GRAN AUTONOMÍA**  
3.7V 1500mAh

SERIE PLASTIC

APLIQUE LED SOLAR PARED 2 DIRECCIONES

IP65

3200K

● APQ-071

Ref

PVPR



Ángulo de luz AJUSTABLE

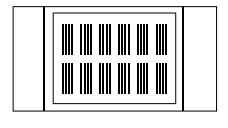

85mm

130mm



**GRAN AUTONOMÍA**  
3.7V 1500mAh

SERIE PLASTIC

APLIQUE LED SOLAR PARED 2 DIRECCIONES

IP65

3200K/5000K

● ● APQ-072

Ref

PVPR

24,54€



Ángulo de luz AJUSTABLE



DUAL COLOR



3200K  
5000K

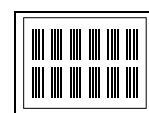

80mm

95mm



5000K

3200K



Botón en la parte trasera



**Batería**  
3.2V 500mAh

APLIQUE LED SOLAR NEGRO RECTANGULAR

Batería Li-Tio 3.2V 500mAh

K°

Ref

PVPR

3200K



APQ-053

20,58€

APLIQUE LED SOLAR NEGRO RECTANGULAR

Batería Li-Tio 3.2V 500mAh

5000K



APQ-054

20,58€



5.25 CM

12 CM



**Battery**  
Li-ion  
**LITHIUM**

**GRAN AUTONOMÍA**  
3.7V 1800mAh  
3.7V 2200mAh

## APLIQUE LED SOLAR CON RADAR SENSOR

**DOS COLORES DE  
LUZ DISPONIBLES**

**DISEÑO MODERNO MINIMALISTA**

3200K ● 5000K ●

APLIQUE LED SOLAR	IP65	BATERÍA 18650 3.7V 1800mAh	300Lm	3200K	●	APQ-059	29,85€
APLIQUE LED SOLAR	IP65	BATERÍA 18650 3.7V 1800mAh	300Lm	5000K	●	APQ-060	29,85€
APLIQUE LED SOLAR	IP65	BATERÍA 18650 3.7V 2200mAh	400Lm	3200K	●	APQ-061	41,85€
APLIQUE LED SOLAR	IP65	BATERÍA 18650 3.7V 2200mAh	400Lm	5000K	●	APQ-062	41,85€

SENSOR RADAR  
DE MOVIMIENTO



**NEW!**



**Battery**  
Li-ion  
**LITHIUM**

**GRAN AUTONOMÍA**  
3.7V 1500mAh

**SERIE PLASTIC**

Ref PVPR

APLIQUE LED SOLAR PARED PIRAMIDE NEGRO IP65 5000K ● APQ-075 11,28€



IP 65



250 Lm



SENSOR PIR  
MOVIMIENTO



130mm

102mm



**Battery**  
Li-ion  
**LITHIUM**

**GRAN AUTONOMÍA**  
3.7V 1200mAh

SENSOR DE MOVIMIENTO PIR Y SENSOR CREPUSCULAR

APLIQUE LED SOLAR PARED IP65 BATERÍA ION LITIO 1200mAh 3.7V 3200K ● APQ-003 12,66€



200 Lm



100



SENSOR PIR  
DE MOVIMIENTO

SENSOR  
CREPUSCULAR



120 mm

93 mm

**NEW PRICE!!**



**Battery**  
Li-ion  
**LITHIUM**

**GRAN AUTONOMÍA**  
3.7V 2200mAh

SENSOR DE MOVIMIENTO PIR Y SENSOR CREPUSCULAR

APLIQUE LED SOLAR PARED IP65 BATERÍA LIFEPO4 2200mAh 3200K ● APQ-005 16,50€

APLIQUE LED SOLAR PARED IP65 BATERÍA LIFEPO4 2200mAh 5000K ● APQ-006 16,50€



400 Lm



100



SENSOR PIR  
DE MOVIMIENTO

SENSOR  
CREPUSCULAR

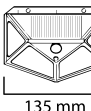

105 mm

135 mm

**NEW PRICE!!**



**Battery**  
Li-ion  
**LITHIUM**

**GRAN AUTONOMÍA**  
3.7V 2200mAh

SENSOR DE MOVIMIENTO PIR Y SENSOR CREPUSCULAR

APLIQUE LED SOLAR PARED IP65 212LED 2 BATERÍA LIFEPO4 2200mAh 3200K ● APQ-044 23,85€

APLIQUE LED SOLAR PARED IP65 212LED 2 BATERÍA LIFEPO4 2200mAh 5000K ● APQ-045 23,85€



600 Lm



100



SENSOR PIR  
DE MOVIMIENTO

SENSOR  
CREPUSCULAR

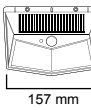

105 mm

157 mm

\* Según la nueva normativa ERP ha habido un cambio en la medición de Lúmenes y vatios, pero sigue emitiendo la misma cantidad de luz. A medida que vayan entrando los nuevos modelos con ERP se irá actualizando en catálogo y cajas de color. Puede haber variación respecto a la caja del producto (comprobar en ficha técnica), todos los datos en catálogo están correctos salvo error tipográfico.



## APLIQUE LED SOLAR CON SENSOR DE MOVIMIENTO

250  
Lm

120°

IP  
65

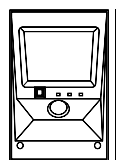

151mm



Botón  
3 MODOS



**GRAN  
AUTONOMÍA**  
3.2V 2000mAh

SENSOR DE MOVIMIENTO PIR - BRAZO GRIS - 18LEDS SMD2835

APLIQUE LED SOLAR MFA

Batería Li-Tio 3.2V 2000mAh

3200K



APQ-051

38,85€

APLIQUE LED SOLAR MFA

Batería Li-Tio 3.2V 2000mAh

5000K



APQ-052

38,85€



3 MODOS - Luz indicadora de cada modo 1  2  3 

- **Modo1: Sensor de movimiento + modo de luz tenue.** La luz tenue siempre encendida (10Lm) si detecta movimiento se activa a 250Lm
- **Modo2: Modo sensor de movimiento.** Si detecta movimiento se enciende gradualmente hasta 250Lm. Sin detección de movimiento se apaga.
- **Modo3: Modo siempre encendido.** Luz fuerte (50Lm) durante las primeras 5horas, luz tenue (20Lm) durante las siguientes 5 horas.



# APLIQUE LED SOLAR

Tres focos 38Leds

**GRAN ÁNGULO**  
DE APERTURA 270°



Botón en la parte trasera

**NEW PRICE!!**



**GRAN AUTONOMÍA**  
3.2V 2500mAh

APLIQUE LED SOLAR TRES FOCOS *LIFEP04 3.2V 2500mAh Li-ion* 5000K ● APQ-050 53,85€

400 Lm

24

120°

IP 65



SENSOR PIR DE MOVIMIENTO

SENSOR CREPUSCULAR

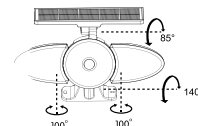
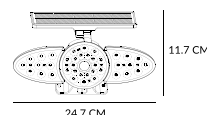

**NEW PRICE!!**



**GRAN AUTONOMÍA**  
3.7V 6000mAh

SENSOR DE MOVIMIENTO PIR Y SENSOR CREPUSCULAR

APLIQUE LED SOLAR DOBLE FOCO ORIENTABLE *LIFEP04 3.7V 6000mAh Li-ion* 3200K ● APQ-013 53,85€

1200 Lm

8

120°

IP 65



SENSOR PIR DE MOVIMIENTO

SENSOR CREPUSCULAR



\* Según la nueva normativa ERP ha habido un cambio en la medición de Lúmenes y vatios, pero sigue emitiendo la misma cantidad de luz. A medida que vayan entrando los nuevos modelos con ERP se irá actualizando en catálogo y cajas de color. Puede haber variación respecto la caja del producto (comprobar en ficha técnica), todos los datos en catálogo están correctos salvo error tipográfico.



NEW PRICE!!



GRAN AUTONOMÍA  
3.7V 1500mAh

LÁMPARA LED SOLAR PARED 5000K IP65 5000K ● APQ-073 Ref PVPR  
12,90€



SERIE PLASTIC



GRAN AUTONOMÍA  
3.7V 1500mAh

Panel solar 5.5V 2w



Botón en la parte delantera

APLIQUE LED SOLAR 3200K ● APQ-063 38,85€

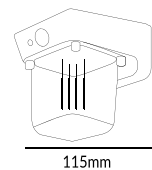



## Serie solar jardin

Pared y suelo

**DUAL  
COLOR**



**Bateria**  
3.7V 600mAh

Incluido Acc de pared y suelo

**SERIE PLASTIC**

LED INCLUIDO

APLIQUE SOLAR PARED/SUELO  
DUAL COLOR 3200K / 5000K

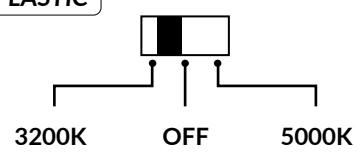

Ref PVPR  
APQ-076 26,85€



- IP 65
- Bateria 3.7V 600mAh
- Panel solar - 5V 80mA
- Gran autonomía
- Carga solar 6-8Hrs



\* Según la nueva normativa ERP ha habido un cambio en la medición de Lúmenes y vatios, pero sigue emitiendo la misma cantidad de luz. A medida que vayan entrando los nuevos modelos con ERP se irá actualizando en catálogo y cajas de color. Puede haber variación respecto la caja del producto (comprobar en ficha técnica), todos los datos en catálogo están correctos salvo error tipográfico.



**NEW!**

Battery  
Li-ion  
LITHIUM

**GRAN AUTONOMÍA**  
3.7V 2000mAh

**Accesorios de pared y suelo incluidos x2**

**BATERÍA: 3.7V 2000mAh - 2 FORMAS DE COLOCACIÓN (PARED - SUELO)**

Ref PVPR

APLIQUE LED SOLAR PARED PIRAMIDE NEGRO	IP65	5000K	APQ-074	59,40€
--	------	-------	---------	--------



IP 44

100 Lm



**SERIE ALUMINIO**



PANEL - VIDRIO



Battery  
Li-ion  
LITHIUM

**GRAN AUTONOMÍA**  
3.7V 2600mAh

**3 en 1 TRES TIPOS DE LUZ EN LA MISMA LUMINARIA**

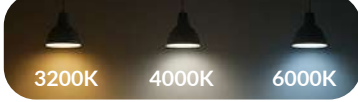

**SENSOR CREPUSCULAR - INCLUIDO ACCESORIO DE PARED**

FAROLA LED SOLAR JARDIN PARED	IP65	BATERÍA LIFEPO4 3.7V 2.6Ah Li-ion	3CCT	FRL-022	50,85€
-------------------------------	------	-----------------------------------	------	---------	--------

400 Lm



120°

IP 65

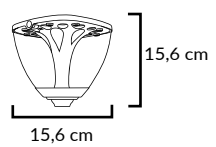

**ACLED-167/168/169**

**NO VIENEN INCLUIDOS SE VENDEN POR SEPARADO**

**ACLED - 168** 7,56€  
Soporte tubo 20cm para farola solar jardin FRL-022

**ACLED - 169** 9,42€  
Soporte pica 23cm para farola solar jardin FRL-022

**ACLED - 167** 7,56€  
Soporte base suelo para farola solar jardin FRL-022  
Ø 6mm



Botón en la parte trasera



FOCO DE PROYECCIÓN



NEW!

Battery  
Li-ion  
LITHIUM

GRAN AUTONOMÍA  
3.7V 1800mAh

ACCESORIO PARED Y SUELO

APLIQUE SOLAR VALLA	3.7V   1800mAh Li-ion	K°	Ref	PVPR
		3200K	APQ-097	23,76€

- 100 Lm
- 1
- 90°
- IP 65
- ↓



\* Según la nueva normativa ERP ha habido un cambio en la medición de Lúmenes y vatios, pero sigue emitiendo la misma cantidad de luz. A medida que vayan entrando los nuevos modelos con ERP se irá actualizando en catálogo y cajas de color. Puede haber variación respecto la caja del producto (comprobar en ficha técnica), todos los datos en catálogo estan correctos salvo error tipográfico.



**GRAN AUTONOMÍA**  
3.2V 2200mAh

**ACLED-194 CCT** **2 EN 1** **DUAL COLOR**  
2 COLORES EN 1

- MODO 1: Blanco frio - Brillo bajo
- MODO 2: Blanco frio - Alta luminosidad
- MODO 3: Blanco calido - Brillo bajo
- MODO 4: Blanco calido - Alta luminosidad
- MODO 5: OFF



- ACLED-195 RGB**
- MODO 1: Blanco frio
  - MODO 2: Rojo
  - MODO 3: Verde
  - MODO 4: Azul
  - MODO 5: Cambio gradual de color
  - MODO 6: OFF

**NEW PRICE!!**



**ACCESORIO PARED Y SUELO**

	K°	Ref	PVPR
FOCO PICA JARDIN 24LED <i>Bateria Li-Tio 18650 3.2V 2200mAh</i>	3200K	ACLED-194	26,85€
FOCO PICA JARDIN 24LED <i>Bateria Li-Tio 18650 3.2V 2200mAh</i>	RGB	ACLED-195	26,85€

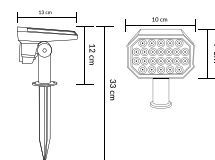

**DISTANCIA SENSOR 4 -6 Metros - INSTALACIÓN EN PARED O SUELO**

**CONTROL POR MANDO A DISTANCIA**

APLIQUE LED SOLAR PARED - PICA	<i>Bateria 1800mAh*2 (3600mAh)</i>	APQ-064	44,85 €
--------------------------------	------------------------------------	---------	---------



**ALTA**  
LUMINOSIDAD  
AUTONOMÍA



**GRAN AUTONOMÍA**  
3.2V 3600mAh



## FOCO PICA JARDIN

60 LEDS 2835



**GRAN AUTONOMÍA**  
3.7V 2200mAh



Batería Li-Tio 18650 3.7V 2200mAh

ACLED-200..... 38,85€



### MODOS DE ILUMINACIÓN

- Modo 1 (Pulsar 1 vez) Luz blanca 6000K
- Modo 2 (Pulsar 2 veces) Luz blanca 6000K brillante
- Modo 3 (Pulsar 3 veces) Luz cálida 3200K
- Modo 4 (Pulsar 4 veces) Luz cálida 3200K brillante
- Modo 5 : OFF

\* Según la nueva normativa ERP ha habido un cambio en la medición de Lúmenes y vatios, pero sigue emitiendo la misma cantidad de luz. A medida que vayan entrando los nuevos modelos con ERP se irá actualizando en catálogo y cajas de color. Puede haber variación respecto la caja del producto (comprobar en ficha técnica), todos los datos en catálogo estan correctos salvo error tipográfico.





*Serie* **Farolas y Campana**

---



Ø Base 48mm

FAROLA LED 30W 5000K FRL-003 56,31€

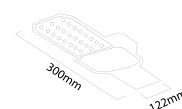

Ø Base 48mm

FAROLA LED 50W 3200K FRL-004 86,70€

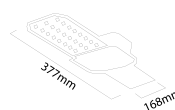

Ø Base 60mm

FAROLA LED 100W 3200K FRL-007 173,34€

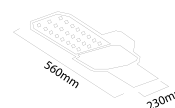

Ø Base 48mm



FAROLA LED	30W	NEW!	K°	Ref	PVPR
FAROLA LED	30W		3200K	FRL-036	78,96€
FAROLA LED	30W		4200K	FRL-024	78,96€
FAROLA LED	30W		5000K	FRL-025	78,96€

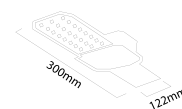

Ø Base 48mm

FAROLA LED	50W		3200K	FRL-026	118,35€
FAROLA LED	50W		4200K	FRL-027	118,35€
FAROLA LED	50W		5000K	FRL-028	118,35€

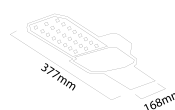

Ø Base 60mm

FAROLA LED	100W	NEW!	3200K	FRL-037	241,98€
FAROLA LED	100W		4200K	FRL-029	241,98€
FAROLA LED	100W		5000K	FRL-030	241,98€

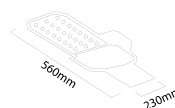

### Soporte Articulado para Farolas

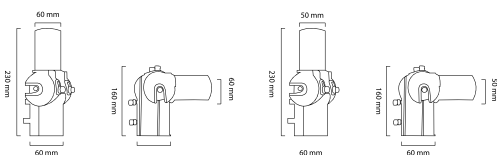

ACLED-103

ACLED-102



ACLED-102 50-60 cm 46,08€ Válido para FRL-024/025/026/027/028 y FRL-010/011/012/013 FRL-003, 004, 036

ACLED-103 60-60 cm 50,37€ Válido para FRL-029/030

### Soporte Acople para Farolas



ACLED-104 50-60 cm



24,54€

Válido para FRL-026/027/028/029/030 y FRL-010/011

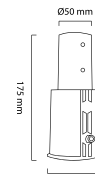

ACLED - 171

Soporte para farola FRL-024 a FRL-030  
Ø 50mm 46 cm  
16,86€



ACLED - 166

Soporte para farola FRL-024 a FRL-030  
Ø 50mm 46cm  
16,86€



# Farola UFO

## 3potencias



**3POTENCIAS**  
80W/100W/120W

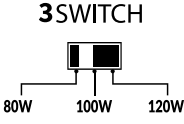

**3 en 1 TRES TIPOS DE LUZ**  
EN LA MISMA LUMINARIA



**NEW!**



Ø Base 63mm - Aluminio

	K°	Ref	PVPR
FAROLA LED UFO 3POTENCIAS 80W / 100W / 120W	3CCT 	FRL-059	179,85€











\* Según la nueva normativa ERP ha habido un cambio en la medición de Lúmenes y vatios, pero sigue emitiendo la misma cantidad de luz. A medida que vayan entrando los nuevos modelos con ERP se irá actualizando en catálogo y cajas de color. Puede haber variación respecto la caja del producto (comprobar en ficha técnica), todos los datos en catálogo estan correctos salvo error tipográfico.

# Serie campanas



OSRAM  
LED Chips

	100W	K°	Ref	PVPR
CAMPANA LED INDUSTRIAL ERIAL	100W	4200K	CMP-005	89,70€
CAMPANA LED INDUSTRIAL ERIAL	100W	5000K	CMP-006	89,70€

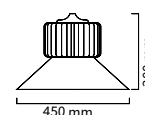

OSRAM  
LED Chips

	150W	K°	Ref	PVPR
CAMPANA LED INDUSTRIAL ERIAL	150W	4200K	CMP-001	105 €
CAMPANA LED INDUSTRIAL ERIAL	150W	5000K	CMP-002	105 €

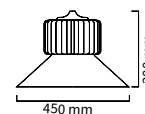

OSRAM  
LED Chips

	200W	K°	Ref	PVPR
CAMPANA LED INDUSTRIAL ERIAL	200W	5000K	CMP-004	110,40€

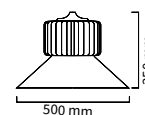

Max. 4 lámparas de 30W

PORTALÁMPARAS	4xE27 - E40	ACLED-010	22,77€
---------------	-------------	-----------	--------

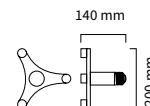

PORTALAMPARA REDUCTOR	E40 A E27	PORTLM-003	2,70€
-----------------------	-----------	------------	-------



Max. 4 lámparas de 30W

COMBINAR CON 4 Lámparas DE 30W Y ADAPTADOR 4XE27-E40 (ACLED-010)

CAMPANA INDUSTRIAL ALUMINIO	Ø 52cm E40	ACLED-024	61,23€
-----------------------------	------------	-----------	--------

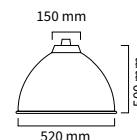



# Campana UFO 3 potencias

**3 POTENCIAS**  
120W/150W/200W

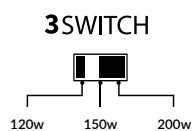

**3 en 1 TRES TIPOS DE LUZ EN LA MISMA LUMINARIA**



Campana **LUMILEDS**

**High Efficiency**  
170Lm/w

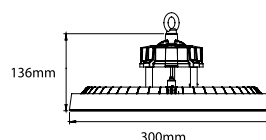

LUMILEDS	LIFUD®	K°	Ref	PVPR
CAMPANA LED UFO LUMILEDS <b>REGULABLE</b>	120W / 150W / 200W	3CCT	CMP-027	137,94€

120 W
150 W
200 W
230 V
4
120°
65 IP
08 IK
>0,9 FP
1-10V
↓



LUMILEDS	LIFUD®	K°	Ref	PVPR
CAMPANA LED UFO LUMILEDS <b>REGULABLE</b>	120W / 150W / 200W	3CCT	CMP-028	192,36€

120 W
150 W
200 W
230 V
4
120°
65 IP
08 IK
>0,9 FP
1-10V
SENSOR PIR MOVIMIENTO



	Ref	PVPR
CONTROL REMOTO PARA CMP-027/028	ACLED-514	72,60€

\* Según la nueva normativa ERP ha habido un cambio en la medición de Lúmenes y vatios, pero sigue emitiendo la misma cantidad de luz. A medida que vayan entrando los nuevos modelos con ERP se irá actualizando en catálogo y cajas de color. Puede haber variación respecto la caja del producto (comprobar en ficha técnica), todos los datos en catálogo están correctos salvo error tipográfico.



**NEW PRICE!!**

## Campanas **LUMILEDS**

**High Efficiency**  
170Lm/w

**LIFUD**  
Led Driver



CAMPANA LED UFO LUMILEDS **REGULABLE**

100W

K°

Ref

PVPR

5000K

CMP-020

111 €

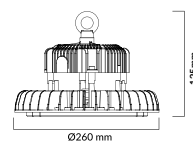

CAMPANA LED UFO LUMILEDS **REGULABLE**

150W

4000K

CMP-021

117 €

CAMPANA LED UFO LUMILEDS **REGULABLE**

150W

5000K

CMP-022

117 €

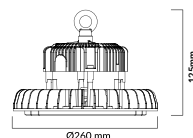

CAMPANA LED UFO LUMILEDS **REGULABLE**

200W

5000K

CMP-023

125,85€

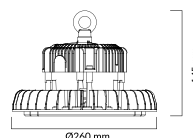

**NEW PRICE!!**

## Campanas **SAMSUNG**

**High Efficiency**  
140Lm/w

**LIFUD**  
Led Driver

Used  
**SAMSUNG**  
LED Chips



CAMPANA LED UFO SAMSUNG **REGULABLE**

100W

4200K

CMP-015

98,40€

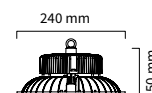

Used  
**SAMSUNG**  
LED Chips



CAMPANA LED UFO SAMSUNG **REGULABLE**

200W

4200K

CMP-018

113,70€

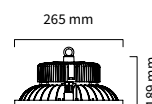

**NEW PRICE!!**



**INCLUYE MANDO 360° DETECCIÓN**

Potencia Máx: 1000W LED - 2000W Incandescente 10-2000lux - máx.10mts radio

SENSOR MOVIMIENTO.HF PARA CAMPANA UFO **5'8GH 360° 10mt** ACLED-145 38,85€



**INSTALACIÓN MÁXIMA 3 CAMPANAS**

15w - 100mA PARA CMP-020/021/022/023/015/018/014

EMERGENCIA KIT PARA CAMPANA UFO **IP65** EMR-025 142,89€



SISTEMA AUTOTEST

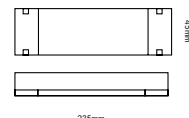

Voltaje entrada 10-22.5 V - 5mA



CONVERTIDOR SEÑAL **DALI A PWM** **IP67** ACLED-176 46,74€



Policarbonato  
Compatible c/ CMP-015-018-014 - Apertura 90°

REFRACTORA PARA CAMPANA UFO SAMSUNG **90° 260mm** CMP-019 44,04€

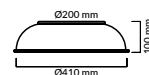

**Para Campanas UFO**

SOPORTE AJUSTABLE TIPO "U" UFO ACLED-146 28,71€





*Serie* **Emergencia y sensores**

---



## Luz de emergencia industrial 2x10w

- Hora de emergencia: >1,5horas
- Duración de la batería: 6,4V - 3400mAh
- Tiempo de carga: 24horas
- Grado IP: IP65
- Lúmenes: 1000Lm
- CCT (K): 6000K ●



**GRAN AUTONOMÍA**  
90MIN



Battery  
**Li-ion LITHIUM** Li-ion 6,4V  
3400mAh



**NEW!**

SISTEMA AUTOTEST



LUZ EMERGENCIA LED DOBLE INDUSTRIAL

2x10w 1000Lm

Ref PVPR  
EMR-030 144,24€

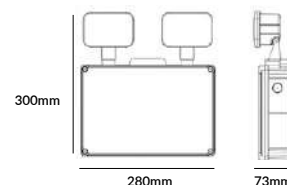

## Serie KIT DE EMERGENCIA

**NEW!**

SISTEMA AUTOTEST



**GRAN AUTONOMÍA**  
180MIN



Battery  
**Li-ion LITHIUM** Li-ion 3,2V  
3000mAh

PARA DOWNLIGHTS Y PANEL LED

KIT DE EMERGENCIA PARA DOWNLIGHTS Y PANEL LED

3 - 60w

EMR-035

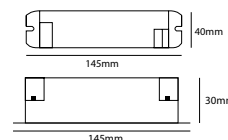

**NEW!**

SISTEMA AUTOTEST



**GRAN AUTONOMÍA**  
60-300MIN



Battery  
**Li-ion LITHIUM** Li-ion 12,8V  
4000mAh

PARA TUBO DE LED

KIT DE EMERGENCIA PARA TUBO DE LED

3 - 40w

EMR-036

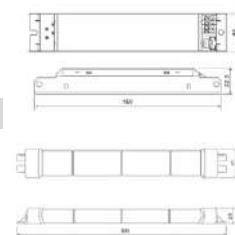

**GRAN AUTONOMÍA**  
120MIN



Battery  
**Li-ion LITHIUM** Li-ion 11,1V  
4400mAh

PARA CAMPANAS UFO

INSTALACIÓN MÁXIMA 3 CAMPANAS

CMP-020/021/022/023/015/018/014

KIT DE EMERGENCIA PARA CAMPANA UFO LED ESTANCA

15w

EMR-025 142,89€

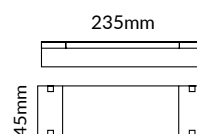

SISTEMA AUTOTEST



VIDEO DE INSTALACIÓN  
CON CAMPANAS

\* Según la nueva normativa ERP ha habido un cambio en la medición de Lúmenes y vatios, pero sigue emitiendo la misma cantidad de luz.

A medida que vayan entrando los nuevos modelos con ERP se irá actualizando en catálogo y cajas de color.

Puede haber variación respecto la caja del producto (comprobar en ficha técnica), todos los datos en catálogo estan correctos salvo error tipográfico.

# Serie emergencia superficie

Caja ABS/Dif. PC - Autonomía 60' Permanent&NoPermanent Ref PVPR



EMERGENCIA LED PERMANENT & NO PERMANENT	75LUM IP42 0.75W	EMR-009	33,72€	↓
EMERGENCIA LED PERMANENT & NO PERMANENT	150LUM IP42 1.5W	EMR-010	33,72€	↓
EMERGENCIA LED PERMANENT & NO PERMANENT	250LUM IP42 2W	EMR-011	39,75€	↓
EMERGENCIA LED PERMANENT & NO PERMANENT	400LUM IP42 4W	EMR-012	51,06€	↓

0,75 W
1,5 W
2 W
4 W
230 V
50
IP 42

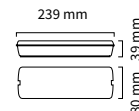

Caja ABS/Dif. PC - Autonomía 60' Permanent&NoPermanent



SISTEMA AUTOTEST

EMERGENCIA LED AUTO-TEST PERMANENT & NO PERMANENT	75LUM IP42 0.75W	EMR-017	40,92€	↓
EMERGENCIA LED AUTO-TEST PERMANENT & NO PERMANENT	150LUM IP42 1.5W	EMR-018	45,93€	↓
EMERGENCIA LED AUTO-TEST PERMANENT & NO PERMANENT	250LUM IP42 2W	EMR-019	50,88€	↓
EMERGENCIA LED AUTO-TEST PERMANENT & NO PERMANENT	400LUM IP42 4W	EMR-020	61,23€	↓

0,75 W
1,5 W
2 W
4 W
230 V
50
IP 42

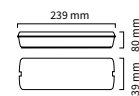

MARCO DE EMPOTRAR TECHO PARA EMERGENCIA LED EMR-002 7,05€ ↓

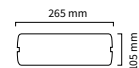

CAJA Y MARCO EMPOTRAR PARED EMERGENCIA LED EMR-003 10,65€ ↓

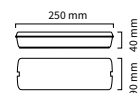

CAJA ESTANCA IP65 EMR-006 18,90€ ↓

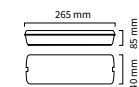



## PEGATINAS SALIDA EMERGENCIA



210x68mm

PEGATINA SALIDA DE EMERGENCIA IZQUIERDA

EMR-015

2,70€



210x68mm

PEGATINA SALIDA DE EMERGENCIA DERECHA

EMR-016

2,70€



210x68mm

PEGATINA SALIDA DE EMERGENCIA ATRÁS

EMR-014

2,70€



210x68mm

PEGATINA SALIDA

EMR-013

2,70€

# Serie emergencia superficie

## EMERGENCIA DE INTERIOR IP20



**Battery**  
Li-ion 3,7V  
1500mAh

Permanent & NoPermanent - Aislamiento CLASE II -  
AUTONOMÍA 60' - Li-ion 3,7V/1.5aH

Ref

EMERGENCIA CIRCULAR SUPERFICIE PERMANENT & NO PERMANENT

EMR-037

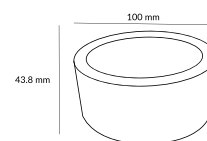

## EMERGENCIA DE EXTERIOR IP65



**Battery**  
Li-ion 3,7V  
1500mAh

Permanent & NoPermanent - Aislamiento CLASE II -  
AUTONOMÍA 60' - Li-ion 3,7V/1.5aH

Ref

EMERGENCIA CIRCULAR SUPERFICIE PERMANENT & NO PERMANENT

EMR-038

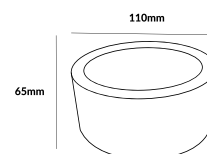
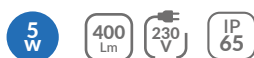



**NEW PRICE!!**

**Battery**  
Li-ion  
**LITHIUM**  
Li-ion 3,7V  
1500mAh



Permanent & NoPermanent - Aislamiento CLASE II -  
AUTONOMÍA 60' - Li-ion 3,7V/1.5aH

LÁMPARA DE EMERGENCIA LED EMPOTRAR AUTO-TEST

Ref PVPR  
EMR-021 52,62€

8 W 400 Lm 230 V 40 IP 42 15 Leds

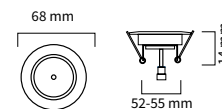

Permanent & NoPermanent - Aislamiento CLASE II -  
AUTONOMÍA 60' - Li-ion 3,7V/1.5aH

EMERGENCIA LED MINI CUADRADO BLANCO EMPOTRAR

Ref PVPR  
EMR-022 50,37€

8 W 400 Lm 230 V 40 IP 42 15 Leds

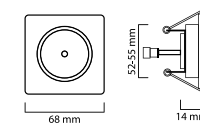

ARO PARA EMERGENCIA MINI  
**EMR-021**



EMR-028 6,48€  
Negro



EMR-027 6,48€  
Aluminio

**DISPONIBLE ARO DE SUSTITUCION**

Aro sustitución:  
Negro - Aluminio



**Battery**  
Li-ion  
**LITHIUM**  
Li-ion 3,7V  
1500mAh

Permanent & NoPermanent -  
AUTONOMÍA 60' - Li-ion 3,7V/1.5aH

LUZ EMERGENCIA LED EMPOTRAR

5w 250Lm

Ref  
EMR-029

5 W 250 Lm 230 V IP 20

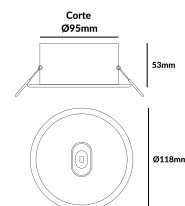

\* Según la nueva normativa ERP ha habido un cambio en la medición de Lúmenes y vatios, pero sigue emitiendo la misma cantidad de luz. A medida que vayan entrando los nuevos modelos con ERP se irá actualizando en catálogo y cajas de color. Puede haber variación respecto la caja del producto (comprobar en ficha técnica), todos los datos en catálogo están correctos salvo error tipográfico.



*Serie* **Sensores**

---



## Sensor domótico

NEW!



Altura de instalación 2,2 - 4m  
 Distancia detección 6 mts <10-2000lux 5seg - 60min

Ref

SENSOR DE MOVIMIENTO INFRARROJO SUPERFICIE TUYA 2000W ACLED-515 58,74€



tuya

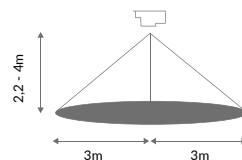

CORTE Ø80mm

Altura de instalación 2 - 4m  
 0-1000lux 5seg - 60min

Diámetro de detección de presencia: 2-6 m.  
 Diámetro de detección de movimiento y micro movimiento: 8 m

NEW!



SENSOR PRESENCIA EMPOTRABLE 2,4GHz TUYA WiFi ACLED-477 143,16€



tuya

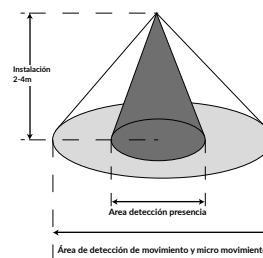



## SENSORES - ALTA FRECUENCIA

### SENSOR DE MICROONDAS

Altura de instalación: Pared 1.5 - 3.5 mts Techo 2 - 8 mts

Distancia detección Techo: 2-16 mts Pared: 5 - 15mts - 3-2000lux - 10seg - 12min



SENSOR DE MOVIMIENTO ALTA FRECUENCIA

5.8Ghz 300W

Ref

PVPR

ACLED-008

25,11€

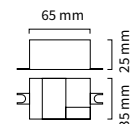

### SENSOR DE MICROONDAS

Distancia detección PARED 5-15mts - TECHO 2-16 mts - 25 - 2000lux - 5seg - 30min

300w LED - 400w Fluorescente - 800w Incandescente



SENSOR DE MOVIMIENTO ALTA FRECUENCIA

AREA LUX MINI

5.8Ghz 300W

Ref

PVPR

ACLED-089

28,71€

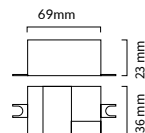

### SENSOR DE MICROONDAS

Distancia detección PARED 5-15mts - TECHO 1-8 mts - <3-2000lux - 10seg - 12min

120w LED



SENSOR DE MOVIMIENTO ALTA FRECUENCIA

AREA LUX MINI

5.8Ghz 120W

Ref

PVPR

ACLED-507

20,16€

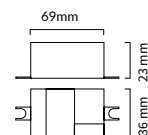

DISTANCIA REGULABLE

← →



Altura instalación: 2-6m

Distancia detección REGULABLE 1-8mts - 3-2000lux - 10seg - 12min

SENSOR DE MOVIMIENTO ALTA FRECUENCIA

5.8Ghz 1000W

Ref

PVPR

ACLED-085

30,30€

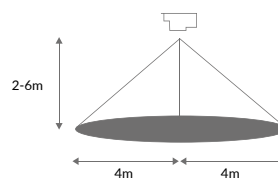

## SENSORES - REAL PRESENCIA

### SENSOR PRESENCIA

Altura de instalación: 2,5m - 4m

Señal de movimiento máxima de 4-5m (radio) (Movimiento de la mano, movimiento de la cabeza)

Señal de respiración de 2-3 m (radio).- 12min



SENSOR DE PRESENCIA EMPOTRADO

360° 400W LED IP65

Ref

PVPR

ACLED-485

79,86€

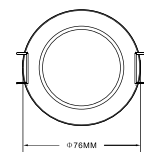
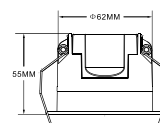

Altura de instalación 2 - 2,5m

Distancia de DETECCIÓN REGULABLE 1,2 - 4,6m



SENSOR DE PRESENCIA SUPERFICIE

360° 1000W LED IP65

Ref

PVPR

ACLED-486

63,42€

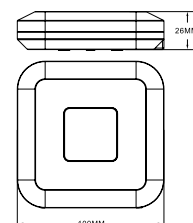



NEW!



CORTE Ø70mm

Altura de instalación 2 - 2,5m

Distancia de DETECCIÓN REGULABLE 1,2,4,6m

Lux regulable 10/30/100 lux

10 seg - 15min

SENSOR DE PRESENCIA SUPERFICIE/EMPOTRADO

360° 400W LED IP20

Ref

PVPR

ACLED-491

77,46€

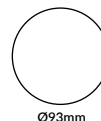

Ø93mm

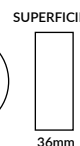

36mm

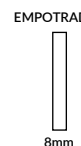

8mm

SENSOR DE PRESENCIA



Altura de instalación 2,2 - 4m

Distancia detección 20mts 3 - 2000lux 10seg - 15min

SENSOR DE PRESENCIA 2 EN 1 EMPOTRADO / SUPERFICIE 1000W

ACLED-081

35,07€

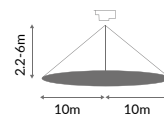
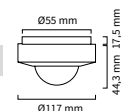

Sensor de presencia 6mts - Distancia máxima de movimiento 20mts 3 - 2000lux 10seg - 30min

SENSOR DE PRESENCIA INFRARROJO

1000W

ACLED-093

38,25€

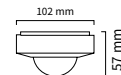

Sensor caja estanco

NEW!



Altura de instalación 1 - 1,8m

Distancia de DETECCIÓN 10m

SENSOR DE MOVIMIENTO ESTANCO 190° 500W LED IP65

Ref

PVPR

ACLED-478

31,65€

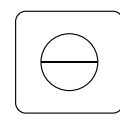
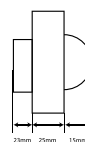

85mm

85mm

NEW!



INCLUYE MANDO

Altura de instalación 1 - 1,8m

Distancia de DETECCIÓN 10m

SENSOR DE MOVIMIENTO INFRARROJO CAJA ESTANCA

180-360° 1000W LED IP65

Ref

PVPR

ACLED-484

42,30€

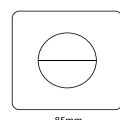
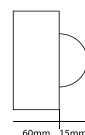

85mm

85mm

\* Según la nueva normativa ERP ha habido un cambio en la medición de Lúmenes y vatios, pero sigue emitiendo la misma cantidad de luz.

A medida que vayan entrando los nuevos modelos con ERP se irá actualizando en catálogo y cajas de color.

Puede haber variación respecto la caja del producto (comprobar en ficha técnica), todos los datos en catálogo están correctos salvo error tipográfico.



## SENSORES - INFRARROJO EMPOTRADO

NEW!



CORTE Ø62mm - Altura instalación: 2-4m  
Distancia diámetro máxima 6mts 5 - 2000lux 10seg - 15min

SENSOR MOVIMIENTO INFRARROJO EMPOTRADO 300W ACLED-032 18,93€

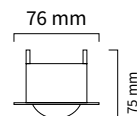
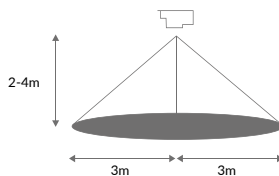

NEW!



CORTE Ø42mm - Altura instalación: 2,2-4m  
Distancia diámetro máxima 6mts 3 - 2000lux 10seg - 15min

SENSOR MOVIMIENTO INFRARROJO EMPOTRADO 300W ACLED-046 19,71€

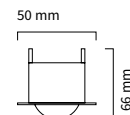
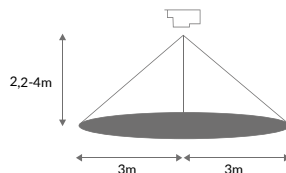

NEW!



CORTE Ø65mm  
Distancia diámetro máxima 8mts - 3-2000lux  
10seg - 7min - Máx. 1000W LED - Altura de instalación 2,2 - 4m

SENSOR MOVIMIENTO INFRARROJO EMPOTRADO 1000W ACLED-108 21,60€



Ref PVPR

ACLED-108 21,60€

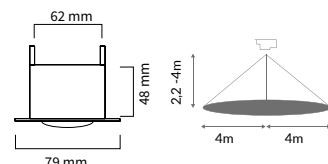

NEW!



Altura de instalación 2 - 4m  
Distancia diámetro máxima 6mts 10 - 2000lux - 5/30seg-1/3/5/8min - 180° - 360°

SENSOR MOVIMIENTO INFRARROJO MINI EMPOTRADO 200W ACLED-033 17,91€

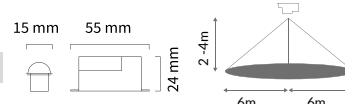

NEW!



CORTE Ø63-66mm  
Altura de instalación 1,8 - 4m  
Distancia de DETECCIÓN 8m

SENSOR DE MOVIMIENTO INFRARROJO EMPOTRADO 360° 600W LED IP65 ACLED-470 17,07€



Ref PVPR

ACLED-470 17,07€

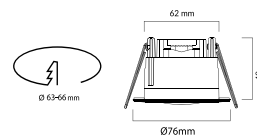

NEW!



CORTE Ø67mm  
Altura de instalación: 2,2 - 4mts  
Distancia detección Ø8mts

SENSOR DE MOVIMIENTO INFRARROJO EMPOTRADO 360° 300W LED IP20 ACLED-480 19,02€



Ref PVPR

ACLED-480 19,02€

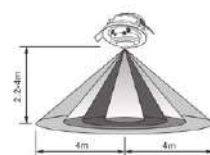
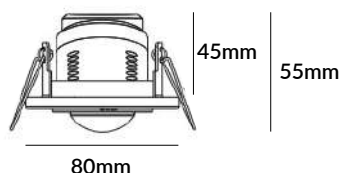

Altura de instalación:  
2,2 - 4mts



NEW!

CORTE Ø12mm

Distancia diámetro máxima 3-6mts - 10 - 2000lux  
5seg - 8min - Máx. 120W LED

SENSOR MOVIMIENTO INFRARROJO EMPOTRADO 12-24V 120/360° 120W ACLED-508 25,44€

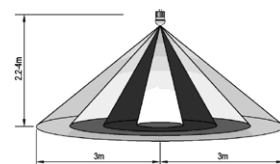

Altura de instalación: 2,2-4m

### SENSOR MOVIMIENTO EMPOTRADO PARED



Distancia diámetro máxima 8mts - 3-2000lux  
10seg - 7min - Máx. 200W LED

SENSOR MOVIMIENTO INFRARROJO EMPOTRADO PARA CAJA 200W ACLED-120 27,45€

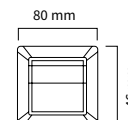

Distancia diámetro máxima 9mts 3 - 2000lux 10seg - 7min

SENSOR MOVIMIENTO INFRARROJO PARA CAJA UNIVERSAL 200W ACLED-084 27,45€

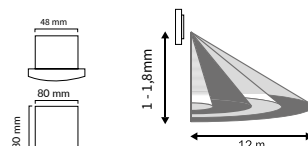

### SENSORES - INFRARROJO EMPOTRADO / SUPERFICIE

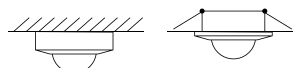

### SENSOR EMPOTRADO 2 EN 1 SUPERFICIE



CORTE Ø76mm

Altura de instalación 2,2 - 6m

Distancia diámetro máxima 6mts - 10-2000lux  
10seg - 7min - Máx. 1000W LED/ 500W INCANDESCENTE

SENSOR MOVIMIENTO INFRARROJO EMPOTRADO / SUPERFICIE 1000W ACLED-107 22,44€

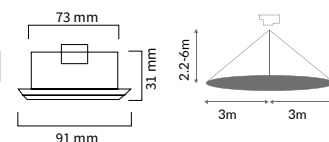

DISTANCIA REGULABLE

CORTE Ø54,5mm

Altura de instalación 2,2 - 4m

Distancia diámetro REGULABLE máxima 16mts - 10-2000lux -  
10seg - 7min - Máx. 1000W LED/ 2000W INCANDESCENTE

SENSOR MOVIMIENTO INFRARROJO EMPOTRADO / SUPERFICIE 1000W ACLED-197 32,34€

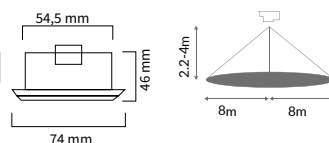

NEW!

CORTE Ø63-66mm

Altura de instalación 2,2 - 4m

Distancia de DETECCIÓN 8m

SENSOR DE MOVIMIENTO INFRARROJO SUPERFICIE/EMPOTRAR 360° 600W LED IP20 ACLED-472 18,84€

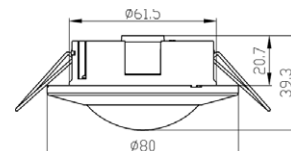



## SENSORES - INFRARROJO SUPERFICIE

DISTANCIA REGULABLE



Altura de instalación 2,2 - 4m

Distancia detección **REGULABLE** 2-20mts 10 - 2000lux 10seg - 10min

SENSOR DE MOVIMIENTO INFRARROJO SUPERFICIE 300W ACLED-036 35,94 €

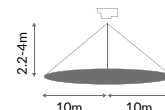
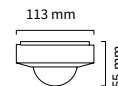

DISTANCIA REGULABLE



Altura de instalación 2,2 - 4m

Distancia detección **REGULABLE** 2-6 mts 10 - 2000lux 10seg - 10min

SENSOR DE MOVIMIENTO INFRARROJO SUPERFICIE SLIM 1000W ACLED-037 22,77€

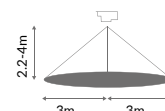
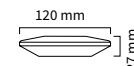

Altura de instalación 2,2 - 4m

Distancia diámetro máxima 8mts - <3-2000lux  
10seg-15min - Máx. 300W LED/ 1000W INCANDESCENTE



SENSOR MOVIMIENTO INFRARROJO SUPERFICIE 300W ACLED-106 19,17€

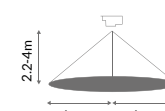
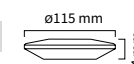

Altura de instalación 2,2 - 4m

Distancia detección 8 mts 10 - 2000lux 10seg - 7min



SENSOR DE MOVIMIENTO INFRARROJO MINI 100W ACLED-086 14,25€

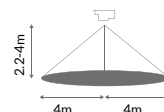
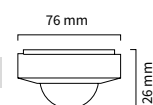

DISTANCIA REGULABLE

NEW!



Altura de instalación 2,2 - 4m

Distancia diámetro **REGULABLE** detección 16mts 3 - 2000lux 10seg - 3min

SENSOR DE MOVIMIENTO INFRARROJO MINI SUPERFICIE 1000W ACLED-198 32,34€

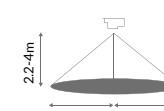
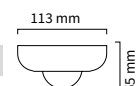

Altura de instalación 2,2 - 4m

Distancia detección 6mts 3 - 2000lux 10seg - 7min



SENSOR DE MOVIMIENTO INFRARROJO SUPERFICIE 300W ACLED-047 16,71€

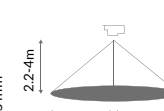
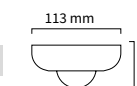

Altura de instalación 4 - 10m

Distancia detección 20 mts 3 - 2000lux 10seg - 30min



SENSOR DE MOVIMIENTO INFRARROJO SUPERFICIE SLIM 1000W ACLED-082 34,65€

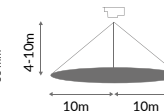
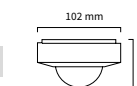

**NEW!**



TECHO PARED

Altura de instalación 1,8 - 2,5m  
Distancia detección 12mts 3 - 2000lux 10seg - 15min

SENSOR DE MOVIMIENTO INFRARROJO 600W ACLED-471 25,62€



DISTANCIA REGULABLE



Altura de instalación 1,8 - 2,5m  
Distancia detección REGULABLE 5 - 12mts 3 - 2000lux 10seg - 7min

SENSOR DE MOVIMIENTO INFRARROJO 300W ACLED-031 17,91€

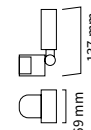
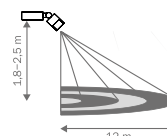

Altura de instalación 1,8 - 2,5m  
Distancia detección 10 mts 3 - 2000lux 10seg - 15min

SENSOR DE MOVIMIENTO INFRARROJO SUPERFICIE SLIM 300W ACLED-080 19,50€

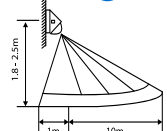

Altura de instalación 1,8 - 2,5m  
Distancia detección 12mts 3 - 2000lux 10 - 15min

SENSOR DE MOVIMIENTO INFRARROJO 300W ACLED-028 22,77€

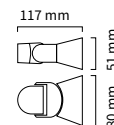
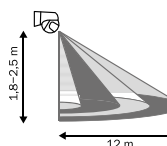

Altura de instalación 1,8 - 2,5m  
Distancia detección 12mts 3 - 2000lux 10seg - 7min

SENSOR DE MOVIMIENTO INFRARROJO 300W ACLED-027 16,26€

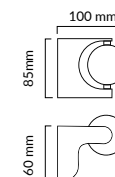
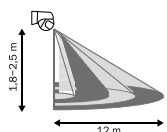

Altura de instalación 1,8 - 2,5m  
Distancia detección 12mts 3 - 2000lux 10seg - 7min

SENSOR DE MOVIMIENTO INFRARROJO 300W ACLED-026 19,17€

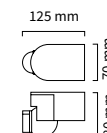
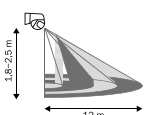

Altura de instalación 1,8 - 2,5m  
Distancia detección 12mts 10 - 2000lux 10seg - 15min

SENSOR DE MOVIMIENTO INFRARROJO SUPERFICIE 300W ACLED-035 19,95€

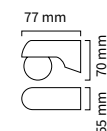
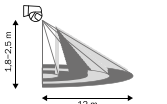



**NEW!**

Altura de instalación 1,8 - 2,5m  
Distancia detección 12mts 3 - 2000lux 10seg - 15min

**SENSOR DE MOVIMIENTO INFRARROJO SUPERFICIE** 60W(12v) - 120w (24v) ACLED-506 20,61€

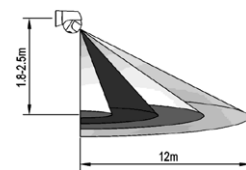

Altura de instalación: 1,8-2,5m



Altura de instalación 2,2 - 4m  
Distancia detección 20mts 10 - 2000lux

Tiempo de retraso: Min.10sec± 3sec  
Max.7min ± 2min

**MINI**

**SENSOR MOVIMIENTO INFRARROJO MINI SUPERFICIE** 20m 360° 300W ACLED-218 27,72€

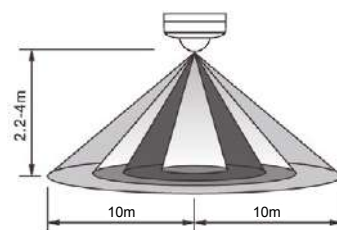
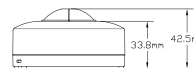
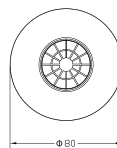

Altura de instalación 2,2 - 4m  
Distancia detección 2-10mts **REGULABLE**

Tiempo de retraso: Min.10sec± 3sec  
Max.7min ± 2min

**MINI**

**SENSOR MOVIMIENTO INFRARROJO MINI SUPERFICIE** 100W ACLED-219 17,91€

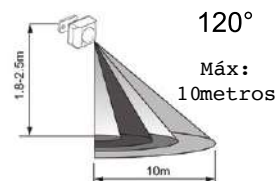
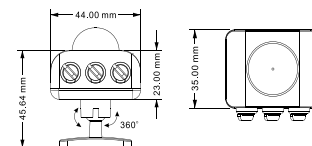
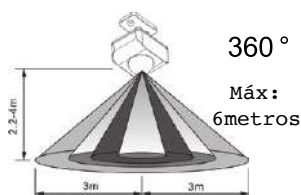

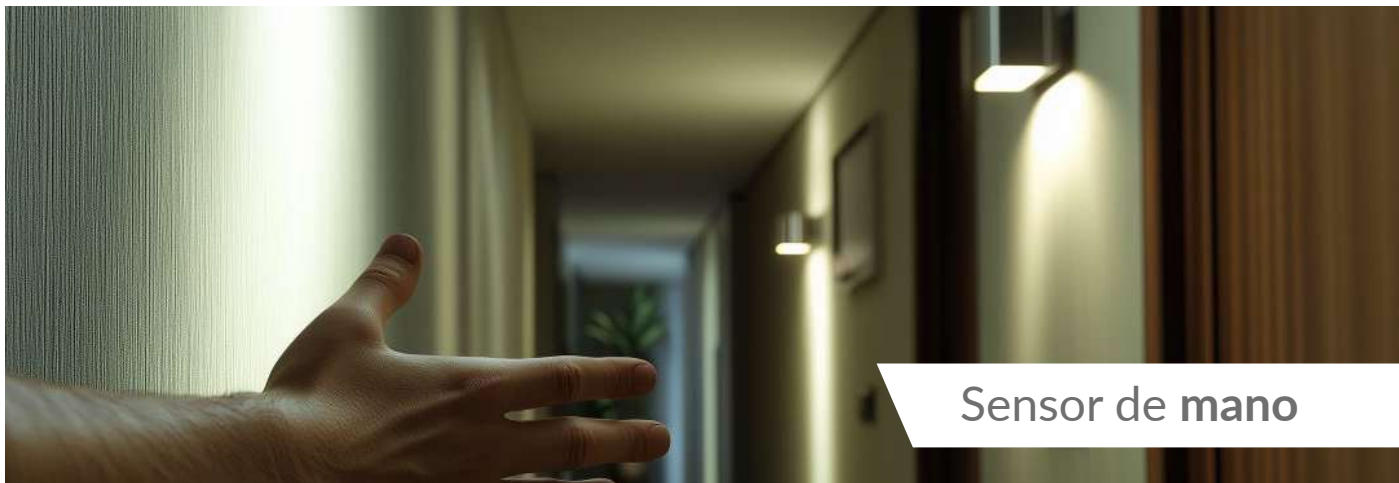

## Sensor de mano



Distancia de DETECCIÓN 5-6cm

SENSOR DE ON/OFF MOVIMIENTO MANO 360° 500W LED IP20

Ref

PVPR

ACLED-473 17,43€



ON/OFF  
SENSOR DE  
MOVIMIENTO  
MANO



## Sensor de puerta



Distancia de DETECCIÓN 5-6cm

SENSOR DE ON/OFF MOVIMIENTO PUERTA 360° 500W LED IP20

Ref

PVPR

ACLED-474 17,43€



ON/OFF  
SENSOR DE  
MOVIMIENTO  
PUERTA



## Sensor de Escalera

**NEW!**



### CONTROLADOR LUZ ESCALERA CON SENSOR PIR

Ref	PVPR
CONTR-102	283,20€



32 CANALES / 1A (CANAL)

[INSTRUCCIONES](#)

[VIDEO  
INSTALACIÓN](#)

#### Incluye:

- PIR Sensor 2Ud (1,2mts)
- Sensor de luz diurna
- Cable sensor PIR (5mts)
- Número de luces de escalera ajustable, máx. 32 peldaños
- 8 velocidades de iluminación graduadas ajustables
- 4 modos de iluminación de trabajo opcionales
- Dos controladores de luz de escalera pueden funcionar en cascada
- Control de interruptor pulsador opcional



### CABEZAL SENSOR DE MOVIMIENTO PIR

Ref	PVPR
CONTR-103	26,82€



## SENSOR CREPUSCULAR



Distancia diámetro máxima 8mts - 3-500lux  
Temporizador incorporado de 1 a 9 horas - Máx. 200W LED

SENSOR CREPUSCULAR SUPERFICIE 10A ACLED-094 22,41€

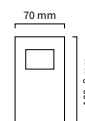

5 - 50 lux

SENSOR CREPUSCULAR 15A ACLED-083 16,89€



5 - 50lux

SENSOR CREPUSCULAR 10A ACLED-030 9,96€

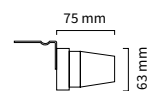

180° DETECCIÓN - 5-15 lux

SENSOR CREPUSCULAR 6A ACLED-029 7,80€

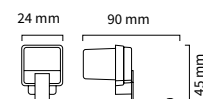

Temporizador incorporado de 1 a 12 horas -  
Máx. 60W LED - 100W INCANDESCENTE 5-15 lux

SENSOR LUZ CREPUSCULAR TEMPORIZADO E27 60W ACLED-034 19,71€

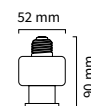



## Serie Linternas profesionales

- Alta luminosidad
- Gran autonomía
- Carga por USB

- Diferentes modos de luz
- Imán de sujeción
- Gran resistencia



**BATERIAS MEJORADAS**



20 uds

120 LM

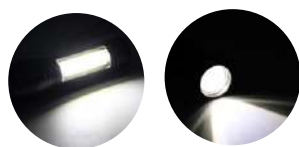

QUITAR SELLO BATERÍAS

LINTERNA MANO ZOOM



91cm BATERÍA LITIO 120Lm Micro-usb

Ref

PVPR

LNT-002

8,94€



Carga por USB

- CABLE INCLUIDO
- BATERÍA LI-TIO 14500 - 700mAh



**GRAN AUTONOMÍA**  
Batería 700mAh

RECARGABLE CARGA USB



Carga por USB

Botón On/Off

Luminaria lateral



- Zoom

+ Zoom

Luminaria principal

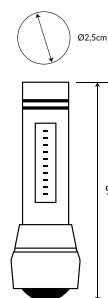

QUITAR SELLO BATERÍAS

LINTERNA MANO/BOLSILLO



BATERÍA DE LITIO 2000mAh Usb

Ref

PVPR

LNT-004

24,45€



12 ud

400 LM



Carga por USB

- CABLE INCLUIDO
- BATERÍA LI-TIO 5v- 18650 - 2000 mAh



**GRAN AUTONOMÍA**  
Batería 2000mAh

RECARGABLE CARGA USB



2 en 1  
DOS LUMINARIAS EN UNA LINTERNA

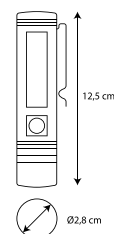



### QUITAR SELLO BATERÍAS

LINTERNA MANO/BOLSILLO **BATERÍA DE LITIO** 2000mAh Usb LNT-007 29,70€

Carga por Tipo-C **USB**

- CABLE INCLUIDO  
- BATERÍA LI-TIO  
**3.7V - 700mAh - 16340**

**GRAN AUTONOMÍA**  
Batería 700mAh  
RECARGABLE CARGA USB

**Battery Li-ion**  
**CLASE A**



12 uds

**600 LM**

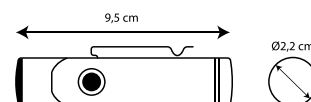

### QUITAR SELLO BATERÍAS

LINTERNA TRABAJO BATERIA LITIO **150Lm Micro-usb** LNT-001 23,25€



Carga por **USB**

- CABLE INCLUIDO  
- BATERÍA LI-TIO  
**3.7V - 1200mAh**

**GRAN AUTONOMÍA**  
Batería 2000mAh  
RECARGABLE CARGA USB

**Battery Li-ion**  
**CLASE A**

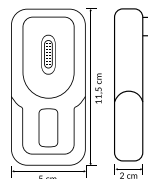

20 uds

**150 LM**



### QUITAR SELLO BATERÍAS

LINTERNA LLAVERO MINI **BATERIA LITIO** 500mAh Usb LNT-005 8,85€

Carga por Tipo-C **USB**

- CABLE INCLUIDO  
- BATERÍA LI-TIO  
**500mAh**

**GRAN AUTONOMÍA**  
Batería 500mAh  
RECARGABLE CARGA USB

**Battery Li-ion**  
**CLASE A**



12 uds

**300 LM**



**IMÁN** en la parte posterior

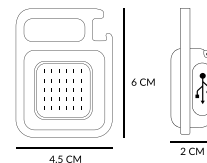

\* Según la nueva normativa ERP ha habido un cambio en la medición de Lúmenes y vatios, pero sigue emitiendo la misma cantidad de luz. A medida que vayan entrando los nuevos modelos con ERP se irá actualizando en catálogo y cajas de color. Puede haber variación respecto a la caja del producto (comprobar en ficha técnica), todos los datos en catálogo están correctos salvo error tipográfico.



1 ud

300 LM

### LINTERNA PROFESIONAL DE CABEZA



QUITAR SELLO BATERÍAS

LINTERNA CABEZA BATERÍA LITIO 2000mAh Usb LNT-003 11,10€

Carga por USB

- CABLE INCLUIDO
- BATERÍA LI-TIO 5v- 18650 - 2000 mAh



GRAN AUTONOMÍA Bateria 2000mAh

RECARGABLE CARGA USB



12 uds

350 LM

QUITAR SELLO BATERÍAS

LINTERNA CABEZA SENSOR BATERÍA DE LITIO 1200mAh Usb LNT-006 20,40€

Carga por Tipo-C USB

- CABLE INCLUIDO
- BATERÍA LI-TIO 1200mAh



GRAN AUTONOMÍA Bateria 1200mAh

RECARGABLE CARGA USB

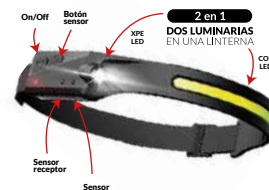

## Serie Lámparas de mesa



**GRAN AUTONOMÍA**  
Batería 2600mAh  
RECARGABLE CARGA USB

**3 en 1 TRES TIPOS DE LUZ**  
EN LA MISMA LUMINARIA

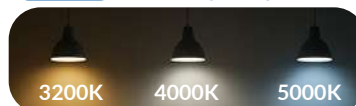

	Ref	PVPR
LÁMPARA DE MESA <b>BATERÍA DE LITIO DIMMABLE ALUMINIO 3CCT</b>	LMP-001	41,22€



LÁMPARA DE MESA <b>BATERÍA DE LITIO DIMMABLE BLANCO 3CCT</b>	LMP-002	41,22€
--	---------	--------



LÁMPARA DE MESA <b>BATERÍA DE LITIO DIMMABLE NEGRO 3CCT</b>	LMP-003	41,22€
---	---------	--------



\* Según la nueva normativa ERP ha habido un cambio en la medición de Lúmenes y vatios, pero sigue emitiendo la misma cantidad de luz. A medida que vayan entrando los nuevos modelos con ERP se irá actualizando en catálogo y cajas de color. Puede haber variación respecto la caja del producto (comprobar en ficha técnica), todos los datos en catálogo están correctos salvo error tipográfico.

# **Domotiza** tu vivienda a la mejor **calidad precio** **SENCILLO Y EFICAZ**



Algunos de nuestros productos son  
Compatibles con los principales asistentes de voz  
(asistente de Google\*, Amazon\*, Alexa\* ... etc.)”v

Estas marcas son propiedad de sus respectivos propietarios,  
y como tal, son reconocidas por Atmoss Electric Equipment S.L  
y son utilizadas únicamente con fines enunciativos.

App  
tuya

# HAZ TU VIDA MÁS FÁCIL Y SEGURA

DOMOTIZA TODO TU HOGAR CON PRODUCTOS DE ATMOS

## Seguridad



Cámaras



Sensores

## Persianas



Pastilla interruptor de persianas.



Mando, Pulsador, interruptor de persianas

## Enchufes



Interruptor wifi. Corte fase y neutro



Enchufe WiFi

## Iluminación



Lámparas WiFi



Pastilla regulador Triac WiFi



Controlador Tiras de led



Proyector WiFi

## Puerta garaje



Pastilla interruptor puerta de garaje.



Pulsador de persianas

Serie Domótica





La mejor forma de ampliar la cobertura WiFi en toda la casa

# Sistema WiFi Mesh

ACLED-199



Cobertura en toda la casa

Hasta 1371m<sup>2</sup>



Conexiones WiFi seguras

Cifrado con seguridad inalámbrica **WPA2-PSK** de alto nivel y posibilidad de crear una **red de invitados** independiente de la red doméstica y de la información privada.



REPETIDOR **WIFI MESH**

Ref	PVPR
ACLED-199.....	311,52€



### Características:

- Tecnología de conectividad: Inalámbrico
- Clase de banda de frecuencia: Doble banda
- Estándar de comunicación inalámbrica: Radiofrecuencia de 5,8 GHz, 802.11a/b/g/n, Radiofrecuencia de 2,4 GHz
- Protocolo de seguridad: WPA2-PSK
- Ancho de banda del puerto LAN: 1000Mbps
- Tasa máxima de transferencia de datos ascendente: 1000 Megabits por segundo
- Sistema Operativo: IOS, Android
- Método de control: App
- Capacidad eléctrica: M3&Dot 100 - 240 V, 50/60 Hz
- Cobertura en toda la casa: Hasta 1371m<sup>2</sup>
- Requisitos para la instalación: iOS 9.0 o posterior, dispositivo Android 4.4 o posterior y servicio de Internet
- Características básicas: SSID Broadcast | Beamforming | MU-MIMO
- Funciones avanzadas: Control parental | Red de invitados | Roaming rápido | QoS inteligente, etc.
- Tipo de conexión a Internet: PPPoE | IP dinámica | IP estática | Modo puente



### Controles parentales potentes

Administra el tiempo de conexión y bloquea el contenido inapropiado en función de la edad para mantener a la familia protegida.

Puedes crear distintos perfiles de usuario y niveles de filtro para cada miembro del hogar.

Además, podrás crear una red de invitados.



# Kit de sonido ambiental Altavoces + amplificador



ALT-003 - Amplificador

Ref PVPR

KIT DE SONIDO I-MASTER+I-AUXILIAR BLUETOOTH	8Oh 6,5" 25W	ALT-001	177,75€	↓
KIT DE SONIDO I-AUXILIAR BLUETOOTH	8Oh 6,5" 25W	ALT-002	45,45€	
AMPLIFICADOR ALTAVOZ. (MÁX 8 ALTAVOCES)	8Oh 4 * 25W	ALT-003	209,40 €	↓



ALT-003

**NO COMPATIBLE CON CAJA UNIVERSAL**

✓ **CAJA DE INSTALACIÓN INCLUIDA**

## INTERFAZ DE CONTROL:

Alimentación: 230 Vac (Rango Admitido 100-250 Vac)

Referencia: ALT-001 / 002  
 Tamaño altavoz: 6.5Inch  
 MAX Power Output: 120W  
 Sensibilidad: 88±3db  
 Impedancia: 8 Ohms  
 Frecuencia: 50-20KHZ  
 Diámetro corte: 6.5Inch(16.5CM)

**Bluetooth®** soportado 3.0

Alcance: 8-10 m  
 Rango frecuencias:  
 2,40 GHz-2,4832 GHz (Banda ISM)

## ALTAVOCES 6,5":

Impedancia: 8 Ω  
 Potencia: 25 W  
 Material: ABS  
 Fijación directa a Falso techo  
 Dim: Ø Exterior: 190mm  
 Ø Corte: 165 mm

## AMPLIFICADOR ALTAVOCES 8OH (MÁX 8 ALTAVOCES)

Potencia: 4\*25w  
 Reproducción mediante:  
 - Tarjeta micro SD ( 32GB ).  
 - Bluetooth ( ≤10m ).  
 - USB ( 32Gb )

Compatible con formato MP3, WMA, WAV, AAC, WAW, APE, etc.

## CABLE DE INSTALACIÓN:

Cable paralelo rojo/negro  
 Distancia máxima 30m

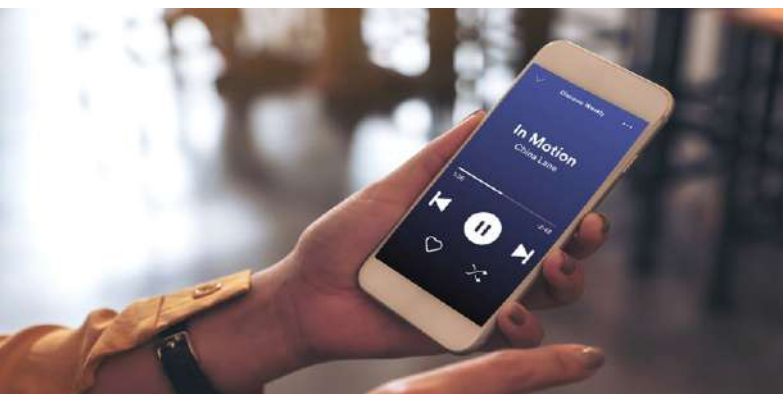

# DOMÓTICA HOUSE SMART

**Tuya Smart** es la **aplicación más utilizada** en el sector del hogar inteligente.

Su funcionamiento está basado en la gestión de dispositivos inteligentes, proporcionando un control total y remoto, además de configurar escenarios predeterminados que aumentan la usabilidad y calidad de la APP.

## SEGURIDAD

Se trata de la configuración de una red de seguridad compuesta por **alarmas, detectores, cerradura inteligente, cámaras...** Permite controlar cualquier tipo de intrusión mediante cámaras de vigilancia o alarmas personales.

## PERSIANAS

**Controla tu persiana** mediante smartphone, mando, pulsador,...

## ENCHUFES

La mejor forma de **controlar el encendido y apagado de dispositivos** conectados a la electricidad. Puede monitorizar el **ahorro de energía**, proteger contra sobretensiones, desconectar la alimentación de la red eléctrica **mediante tu smartphone**.

## PUERTA GARAJE

**Automatiza tu puerta del garaje**, abre tu puerta sin necesidad de bajar del vehículo.

## ILUMINACIÓN

**Crea diferentes ambientes** con nuestras lámparas WiFi. Controla el encendido o apagado, la regulación o el color desde la App.



## VENTAJAS

- Ayuda para personas con movilidad reducida.
- Ahorro energético.
- Mejor confort.
- Fácil instalación.
- Domotiza tu vivienda a un precio reducido.
- Amplía la cobertura WiFi en tu vivienda.



## Serie Cámaras Wifi vigilancia interior

La cámara **DOMO CAM-005** cuenta con un diseño en forma de cúpula ideal para protección de espacios interiores. Ideal para pasar inadvertido, colocación en el techo con una rotación y visión panorámica.

**ALTA RESOLUCIÓN 2K**

COMPATIBLE CON APP **tuya**

### CÁMARA DOMO WIFI VIGILANCIA 3-PRO PTZ INTERIOR

- WIFI
- COMPATIBLE CON TUYA
- SEGUIMIENTO DE OBJETOS
- 1080P
- PTZ
- VISIÓN NOCTURNA EN COLOR
- ROTACIÓN PANORÁMICA
- COMPATIBLE CON LOS PRINCIPALES ASISTENTES DE VOZ



**BLANCA - VISIÓN NOCTURNA EN COLOR - ROTACIÓN PANORÁMICA**

"Compatible con los principales asistentes de voz (asistente de Google\*, Alexa\*)"

CAMARA DOMO WIFI VIGILANCIA 3-PRO PTZ INTERIOR **2K 3.0MP** CAM-005 125,94€



MOTORIZADO



MANUAL



Ficha técnica



Video vinculación con TUYA

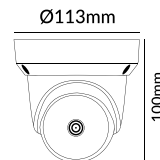

5V - 1A

**tuya**

CONEXIÓN USB



\* Según la nueva normativa ERP ha habido un cambio en la medición de Lúmenes y vatios, pero sigue emitiendo la misma cantidad de luz.

A medida que vayan entrando los nuevos modelos con ERP se irá actualizando en catálogo y cajas de color.

Puede haber variación respecto a la caja del producto (comprobar en ficha técnica), todos los datos en catálogo están correctos salvo error tipográfico.



CÁMARA WIFI VIGILANCIA <i>MINI-E27 PTZ INDOOR</i>		Ref	PVPR
		CAM-008	80,40€



Ficha técnica

**2.0MP**  
MEGAPIXEL

COMPATIBLE  
CON APP **tuya**



CONEXIÓN  
E27

## CÁMARA CON ROSCA E-27

## FACIL INSTALACIÓN



### - TRANQUILIDAD ASEGURADA -

Mantén **SEGURO** tu hogar con las cámaras "Black-Eye"

### - MULTIPLES INSTALACIONES -

Techo - Sobremesa - Pared



Notificaciones emergentes de señal de alarma.



Seguimiento de movimiento.

**2.0MP**  
MEGAPIXEL

COMPATIBLE  
CON APP **tuya**



CÁMARA WIFI VIGILANCIA <i>BLACK-EYE INDOOR PTZ</i>		Ref	PVPR
		CAM-007	83,16€



5V - 1A



# CÁMARA DE SEGURIDAD WIFI

Soporte retráctil y giratorio



### DETECCIÓN DE MOVIMIENTO

Envía notificaciones al smartphone cuando detecta movimiento.

**2.0MP**  
MEGAPIXEL

COMPATIBLE CON APP **tuya**



WIFI



2 canales audio



Sin instalación



Sensor de movimiento



PTZ



Resolucion HD



Admite tarjeta SD



Visión nocturna a color



CÁMARA WIFI MINI CUBO **VIGILANCIA INTERIOR**

Ref PVPR

CAM-012 56,85€



\* Según la nueva normativa ERP ha habido un cambio en la medición de Lúmenes y vatios, pero sigue emitiendo la misma cantidad de luz. A medida que vayan entrando los nuevos modelos con ERP se irá actualizando en catálogo y cajas de color. Puede haber variación respecto a la caja del producto (comprobar en ficha técnica), todos los datos en catálogo están correctos salvo error tipográfico.



**NEW PRICE!!**

**SOLO ES COMPATIBLE CON LA RED 2,4G - NO CONECTAR A UNA RED 5G O DUAL POR BLOQUEO DE CÁMARA**



**1080P - BLANCA - VISIÓN NOCTURNA EN COLOR - Motorizada**

**CAMARA WIFI VIGILANCIA 2-PRO PTZ INTERIOR** **IP40** CAM-004 50,25€

5V - 2A

[Ficha técnica](#)

[Video vinculación con TUYA](#)

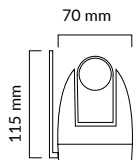

WiFi

**COMPATIBLE CON APP** **tuya**

**CONEXIÓN USB**

# Serie Cámaras Wifi vigilancia exterior

## Exterior IP65



**4.0MP**  
MEGAPIXEL



COMPATIBLE  
CON APP **tuya**

**ALTA RESOLUCIÓN** **2K**  
QUADHD



**CAM-009**



90°

355°

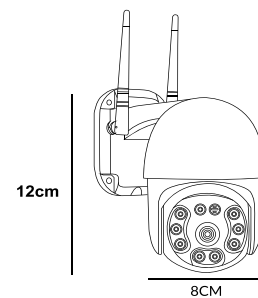

**2K - BLANCA - VISIÓN NOCTURNA EN COLOR - MOTORIZADA**

	Ref	PVPR
CAMARA WIFI VIGILANCIA <b>2K 4MP IP66</b>	CAM-009	119,70€



\* Según la nueva normativa ERP ha habido un cambio en la medición de Lúmenes y vatios, pero sigue emitiendo la misma cantidad de luz. A medida que vayan entrando los nuevos modelos con ERP se irá actualizando en catálogo y cajas de color. Puede haber variación respecto a la caja del producto (comprobar en ficha técnica), todos los datos en catálogo están correctos salvo error tipográfico.

COMPATIBLE CON APP **tuya**

## CÁMARA EXTERIOR SOLAR ☀️

Conecta tu cámara sin necesidad de cableado, ni toma eléctrica

**3.0MP**  
MEGAPIXEL

SISTEMA  
4G

SISTEMA  
WIFI

**IP66**

COMPATIBLE CON APP **tuya**

Battery  
Li-ion  
LiFePO4

Batería 4uds  
18650 5W



La **CAM-010** Cámara 4G Solar es perfecta para sitios que no hay energía eléctrica o sin Wifi.

Como granjas, sitios de construcción, casas de vacaciones, almacenes, etc.

\* **Acepta Tarjeta SIM, (NO INCLUIDA)**



		Ref	PVPR
CÁMARA SOLAR 4G	<a href="#">3MP</a> <a href="#">PTZ</a> <a href="#">EXTERIOR</a> <a href="#">IP66</a>	CAM-010	322,38€
CÁMARA SOLAR WIFI	<a href="#">3MP</a> <a href="#">PTZ</a> <a href="#">EXTERIOR</a> <a href="#">IP66</a>	CAM-011	265,68€





## Serie sistemas profesional de vigilancia Exterior IP65

**CÁMARAS EXTERIOR** IP 65

**SISTEMA POE**  
Conexión por cable

Cuerpo de **Aluminio**



### CÁMARA TIPO BULLET

Ideal para vigilancia de aire libre y zonas de amplio rango de visión.

Debido a su diseño alargado le permite cubrir una amplia zona de visión.

- Detección de cuerpo humano
- Enfoque automático
- Grabación automática
- Aluminio
- Notificación por detección de movimiento
- Conexión por cable
- Videograbador con marcas de agua
- Compatible con los sistemas de control de voz
- Cámaras fijas

## Sistema profesional de vigilancia

Visión por APP **tuya** Smartphone o ordenador



CONEXIÓN POR CABLE - Compatible con los principales sistemas de control por voz - Fijas - VIDEOGRABADOR CON MARCAS DE AGUA



SISTEMA POE 2K QUADHD 5.0MP MEGAPIXEL 1TB HDD 4CH

KIT CAMARAS SEGURIDAD	Ref	PVPR
WIFI TUYA 4CH 2K 1TB + HDD	SGR-029	836,55€

230v 1 SISTEMA POE IP 65 tuya



SISTEMA POE 2K QUADHD 5.0MP MEGAPIXEL 2TB HDD 8CH

KIT CAMARAS SEGURIDAD	Ref	PVPR
WIFI TUYA 8CH 2K 2TB + HDD	SGR-030	1553,58€

230v 1 SISTEMA POE IP 65 tuya

\* Según la nueva normativa ERP ha habido un cambio en la medición de Lúmenes y vatios, pero sigue emitiendo la misma cantidad de luz. A medida que vayan entrando los nuevos modelos con ERP se irá actualizando en catálogo y cajas de color. Puede haber variación respecto a la caja del producto (comprobar en ficha técnica), todos los datos en catálogo están correctos salvo error tipográfico.



## CÁMARAS EXTERIOR

IP 65



SISTEMA POE



Conexión por cable

- Detección de cuerpo humano
- Enfoque automático
- Grabación automática
- Aluminio
- Notificación por detección de movimiento
- Conexión por cable
- Videograbador con marcas de agua
- Compatible con los sistemas de control de voz
- Cámaras con movimiento PTZ 355° y 90°
- Bidireccional



## Sistema profesional de vigilancia

Visión por APP **tuya** Smartphone o ordenador



CONEXIÓN POR CABLE - Compatible con los principales sistemas de control por voz - PTZ - VIDEOGRABADOR CON MARCAS DE AGUA



KIT CAMARAS SEGURIDAD	Ref	PVPR
WIFI TUYA 4CH 2K 1TB + HDD	SGR-032	855,42€



KIT CAMARAS SEGURIDAD	Ref	PVPR
WIFI TUYA 8CH 2K 2TB + HDD	SGR-033	1440,36€





**CÁMARAS EXTERIOR** IP 65

**VISIÓN NOCTURNA A COLOR**

**SISTEMA WIFI**

**SE ENCIENDE EL FLASH AL DETECTAR MOVIMIENTO**

**SEÑAL WIFI NO AMPLIFICABLE**

- Hasta 450 m de distancia de transmisión sin barreras.
- 30 m a través de paredes.
- \* ( Sujeto a variaciones según condiciones de instalación )

**Sistema profesional de vigilancia**

Visión por APP **tuya** Smartphone o ordenador

CONEXIÓN WIFI - Compatible con los principales sistemas de control por voz - PTZ - VIDEOGRABADOR CON MARCAS DE AGUA



KIT CAMARAS SEGURIDAD	Ref	PVPR
WIFI <b>TUYA</b> 8CH 2K 2TB + HDD	SGR-031	874,29€

**CAMARAS CON VIDEOGRABADOR IP65**



CONEXIÓN POR CABLE - Compatible con los principales sistemas de control por voz - Fijas VIDEOGRABADOR CON MARCAS DE AGUA

Ref PVPR

KIT CAMARAS SEGURIDAD TUYA	CABLE RED 4CH 1080P POE 1TB HDD	SGR-007	718,62€
----------------------------	---------------------------------	---------	---------

**Contenido de la caja:**

- 1 Grabador NVR con HDD
- 4 Cable red 2x18,5m-2x30,5m
- 1 Ratón USB
- 1 Adaptador 52V 2A Grabador
- 4 Cámaras IP
- 1 Manual de usuario
- 4 Llave Allen para cámaras
- 4 Bolsa tornillos (para cámaras)

\* Según la nueva normativa ERP ha habido un cambio en la medición de Lúmenes y vatios, pero sigue emitiendo la misma cantidad de luz. A medida que vayan entrando los nuevos modelos con ERP se irá actualizando en catálogo y cajas de color. Puede haber variación respecto a la caja del producto (comprobar en ficha técnica), todos los datos en catálogo están correctos salvo error tipográfico.



## Serie Iluminación domótica

APP CONTROL REMOTO

COMPATIBLE CON APP **tuya**

### Iluminación



### Administre su iluminación desde cualquier lugar con WiFi



	°K	Ref	PVPR
Miniesférica Led WiFi REGULABLE	G45 E14 5W 470Lm	BLED-221	21,51€
Miniesférica Led WiFi REGULABLE	G45 E27 5W 470Lm	BLED-220	21,51€

**tuya**

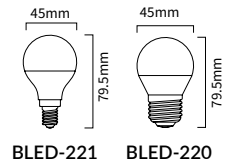

Standar Led WiFi REGULABLE	A60 E27 10W 900Lm	BLED-219	21,51€
----------------------------	-------------------	----------	--------

**tuya**



Dicroica Led WiFi REGULABLE	GU10 5W 400Lm	DIC-090	21,51€
-----------------------------	---------------	---------	--------

**tuya**

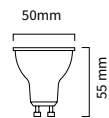

Globo Led WiFi REGULABLE	G95 E27 11W 1055Lm	BLED-222	28,71€
Globo Led WiFi REGULABLE	G120 E27 15W 1520Lm	BLED-223	32,31€

**tuya**

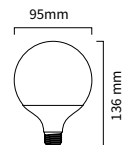

INCLUYE MANDO

	°K	Ref	PVPR
TRACK LIGHT LED INTEGRADO 3CCT	WiFi 30W Blanco 3CCT	TRCK-056	125,94€
TRACK LIGHT LED INTEGRADO 3CCT	WiFi 30W Negro 3CCT	TRCK-057	125,94€

**tuya**

TRCK-058 LENTE INTERCAMBIABLE 60°

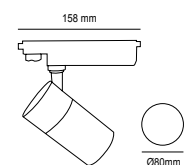



INCLUYE MANDO

**OSRAM**  
LED Chips \* Compatible con TUYA

PROYECTOR DOWNLIGHT RECTANGULAR BLANCO **WIFI - 40w** 3CCT PRY-138 142,56€

40w 4000 Lm 120° 230V >0,9 FP IP 20 8 WiFi 3CCT tuya

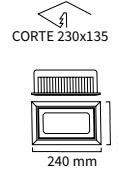

INCLUYE MANDO

\* Compatible con TUYA - Mando incluido RF - REGULABLE

PANEL LED 60 X 60CM **WIFI 40W - ARO BLANCO** 3CCT + RGB DOW-318 208,92€

4000 Lm 120° 230V >0,9 FP IP 40 8 3CCT RGB WiFi tuya

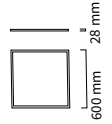

COMPATIBLE CON TUYA - INCLUYE MANDO RF - CON MEMORIA

Para el funcionamiento del mando a distancia es necesario vincular primero el proyector a su conexión wifi.



INCLUYE MANDO

PROYECTOR EXTERIOR WIFI **10W - 750Lm - IP65** RGB 3CCT PRY-104 62,73€

10 W tuya

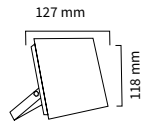

PROYECTOR EXTERIOR WIFI **20W - 1600Lm - IP65** RGB 3CCT PRY-105 66,18€

20 W 230V 10 120° IP 65 >0,9 FP WiFi RGB 3CCT tuya

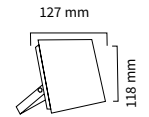

Combina los colores como quieras con el modo RGB.

O cambia de tono entre 3200K hasta 5000K con el modo 3CCT.

Desde un tono cálido, pasando por un blanco hasta un tono frío.



**3 en 1 TRES TIPOS DE LUZ EN LA MISMA LUMINARIA**

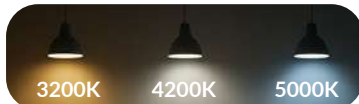

Switch 3CCT

\* Según la nueva normativa ERP ha habido un cambio en la medición de Lúmenes y vatios, pero sigue emitiendo la misma cantidad de luz. A medida que vayan entrando los nuevos modelos con ERP se irá actualizando en catálogo y cajas de color. Puede haber variación respecto la caja del producto (comprobar en ficha técnica), todos los datos en catálogo están correctos salvo error tipográfico.

App  
tuya

## Serie pastillas de iluminación domótica

Compatible con los principales sistemas de control por voz



Para interruptor simple, conmutado y cruce

PASTILLA INTERRUPTOR MINI LED



WIFI 300W LED

Ref

CONTR-054

PVPR

41,91€



tuya

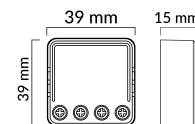

Pastilla MINI  
39x39x15mm



No apta para instalaciones conmutables

PASTILLA INTERRUPTOR MINI MULTIFUNCIÓN

WIFI 300W LED

CONTR-082

29,85€



tuya

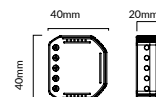

Para DOBLE interruptor e interruptor partido

PASTILLA DOBLE INTERRUPTOR LED

WIFI 2 X 150W

CONTR-042

56,31€



tuya

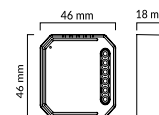

Disponible  
para varios  
pulsadores



PASTILLA DIMMABLE TRIAC

WIFI 300W LED

WIFI 300W LED

CONTR-063

60,66€



tuya

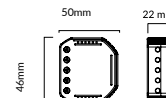

PASTILLA TELERRUPTOR MINI WIFI

16A 230V - 300W LED

CONTR-071

45,06€



tuya

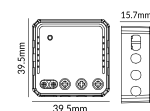



CONTROLADOR **DIMMABLE TRIAC** WIFI PULSADOR **WIFI 500W LED** CONTR-096 84,30€



tuya



- CONEXIÓN WIFI, 2,4Ghz, BLUETOOTH
- CONTROL REMOTO 2,4Ghz
- DIMMABLE 0-100% SIN PARPADEO

NEW!



Compatible con CONTR-105 - NO INCLUIDO

Ref

PVPR

PASTILLA **DIMMABLE TRIAC** WIFI RF UART HOLE **200W**

CONTR-104 58,50€



tuya



Accesorio control remoto pulsador dimmable **CONTR-105**

CONTR-105 14,43€

NEW!



Compatible con CONTR-118 - NO INCLUIDO

Ref

PASTILLA ON/OFF WIFI RF UART HOLE **250W**

CONTR-117



tuya



Mando control remoto ON/OFF **CONTR-105**

CONTR-118

**NO DISPONE DE WIFI**



PASTILLA REGULACIÓN LED **SIN NEUTRO MÁX 250W**

Ref

PVPR

CONTR-083 55,02 €

REGULACIÓN TRIAC



Este dimmer LED está diseñado para el control de lámparas LED regulables de hasta 250W. Con características de diseño compacto, brillo ajustable, potencia y memoria de ajuste de luz, es fácil de instalar y operar.

- Tamaño compacto
- Sin ruido
- Regulación del borde de salida
- No necesita línea neutra
- Ideal para reequipamiento
- Luminosidad y velocidad de regulación regulables
- Memoria de potencia y luminosidad

- REGULACIÓN TRIAC

- NO APTA PARA INSTALACIONES CONMUTADAS

- SE PUEDE USAR CON PULSADORES EN PARALELO

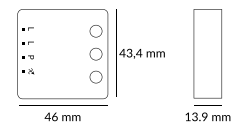

**NO DISPONE DE WIFI**



PASTILLA PULSADOR CON EFECTO MEMORIA - FUNCIONA PARA VARIOS PULSADORES -

PASTILLA **DIMMABLE TRIAC** POR PULSADOR

**MÁX 360W**

CONTR-022

52,62€



COMPATIBLE CON MANDO **CONTR-036 Y CONTR-056**

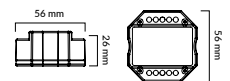

CONTR-036 CONTR-056

## Serie controlador tiras led domótica

App  
tuya

## Convierte y controla tu instalación de tiras LED en WiFi



Hasta 5 canales (5 en 1), diferentes colores, con un mismo controlador en un mismo lugar.

COMPATIBLE  
CON APP **tuya**

Función 5 en 1 solo en CONTR-108, 109, 061, 062

### • Para tiras Monocolor



#### PARA TIRAS MONOCOLOR

Compatible con CONTR-107 - NO INCLUIDO

PUSH + RF

\* FUNCIONA CON MANDO, y APP Tuya

PASTILLA REGULACIÓN TIRA LED MONO	WIFI 10A - 240W	Ref	PVPR
		CONTR-106	70,20€



**tuya**

Máx: 10A - 2.4GHz

\* COMPATIBLE CON MANDO CONTR-107 48,60€

\* COMPATIBLE CON APP TUYA SMART LIFE.



### • Para tiras 3CCT y Monocolor



Ref

PVPR



#### PARA TIRAS 3CCT y MONOCOLOR

\* FUNCIONA CON PULSADOR y APP Tuya

CONTROLADOR TIRA LED 3CCT	WIFI	Ref	PVPR
		CONTR-060	75,87€



**tuya**



Máx: 10.5A - 5A/CH - 2 canales - 2.4GHz

\* COMPATIBLE CON APP TUYA SMART LIFE.



#### PARA TIRAS 3CCT y MONOCOLOR

\* FUNCIONA CON PULSADOR, Mando, y APP Tuya

CONTROLADOR TIRA LED 2 EN 1	WIFI	Ref	PVPR
		CONTR-097	68,46€



**tuya**



Máx: 12A - 12A/CH - 2 canales - 2.4GHz

\* COMPATIBLE CON APP TUYA SMART LIFE.

\* COMPATIBLE CON MANDO CONTR-030



### • Para tiras RGB



#### PARA TIRAS RGB 24V - CODIFICADO

\* FUNCIONA CON APP Tuya Y CONTROL REMOTO INCLUIDO

CONTROLADOR TIRA LED RGB	WIFI	Ref	PVPR
		CONTR-080	101,40€



**tuya**

Máx: 15A - 3A/CH - 3 canales - 2.4GHz

\* COMPATIBLE CON APP TUYA SMART LIFE.

Para tiras **RGB** y **3CCT** **FUNCIÓN 5 EN 1**



PARA TIRAS **3CCT, RGB+W y 3CCT+RGB**

\* FUNCIONA CON PULSADOR, Mando, y APP Tuya

CONTROLADOR TIRA LED 5 EN 1 **WIFI** CONTR-108 63,75€



tuya



Máx: 20A - 15A/CH - 5 canales - 2.4GHz

\* COMPATIBLE CON APP TUYA SMART LIFE.

\* COMPATIBLE CON MANDO CONTR-028



PARA TIRAS **3CCT, RGB+W y 3CCT+RGB**

\* FUNCIONA CON PULSADOR, Mando, y APP Tuya

CONTROLADOR MINI TIRA LED 5 EN 1 **WIFI** CONTR-109 59,85€



tuya



Máx: 10A - 6A/CH - 5 canales - 2.4GHz

\* COMPATIBLE CON APP TUYA SMART LIFE.

\* COMPATIBLE CON MANDO CONTR-028



PARA TIRAS **3CCT, RGB+W y 3CCT+RGB**

\* FUNCIONA CON APP Tuya

CONTROLADOR TIRA LED 5 EN 1 **WIFI** CONTR-061 75,87€

CONTROLADOR TIRA LED 5 EN 1 **WIFI - BLUETOOTH** CONTR-062 70,98€



tuya

Máx: 15A - 3A/CH - 5 canales - 2.4GHz

\* COMPATIBLE CON APP TUYA SMART LIFE.

Para tiras **Digitales**



Válido para TLED-135-170-171

Ref

PVPR

CONTROLADOR LED 8A **RGB/RGBW DIGITAL SPI** CONTR-100 73,32€



tuya



INSTRUCCIONES



VIDEO INSTALACIÓN



Color



Blanco



Carta de colores



Combinación

Personaliza completamente una gran cantidad de modos de color RGB / RGBW



Ritmo musical



Escenas



Mezcla de colores por segmentos



Temporizador



Control por voz



Control por APP



16 millones de colores



Ajuste de brillo

\* Según la nueva normativa ERP ha habido un cambio en la medición de Lúmenes y vatios, pero sigue emitiendo la misma cantidad de luz. A medida que vayan entrando los nuevos modelos con ERP se irá actualizando en catálogo y cajas de color. Puede haber variación respecto a la caja del producto (comprobar en ficha técnica), todos los datos en catálogo están correctos salvo error tipográfico.



Serie sistemas **DALI**

3200 Kelvin

5000 Kelvin

## • Eficiencia, precisión y flexibilidad

Sistema de control **DALI**:

*DALI (Digital Addressable Lighting Interface)* es un sistema de control digital estandarizado diseñado para gestionar de forma inteligente instalaciones de iluminación. Permite el encendido, apagado y regulación de luminarias individuales o en grupos, facilitando un control preciso, eficiente y personalizado en todo tipo de espacios.

Gracias a su estructura descentralizada y su comunicación bidireccional, DALI simplifica la instalación, mejora el mantenimiento y ofrece una gran flexibilidad a la hora de crear escenas o integrar sensores de presencia y luz natural.

Ideal para oficinas, centros comerciales, hoteles o edificios públicos, el sistema DALI se ha consolidado como una solución robusta y escalable para proyectos de iluminación profesional.

## • Una luz inteligente ahorra energía

Una de las funciones principales de DALI es la regulación progresiva de lámparas LED. La adaptación de la luminosidad a las necesidades reales de los usuarios evita el consumo innecesario de energía.

Serie sistemas

Este tipo de sistema se puede aplicar en diversos entornos donde se requiere un control preciso y eficiente de la iluminación.

Por ejemplo:

Edificios comerciales, oficinas, colegios, centros de salud, naves, aeropuertos,...



Control remoto mediante mando RF o aplicación Tuya

Función 6 en 1 - Temperatura de color, RGB, RGBW, RGB+CCT

CONVERTIDOR WIFI/RF A DALI CONTR-113



Compatible con CONTR-113

CONTROL REMOTO 8 ESCENAS 8 ZONAS CONTR-114



Funciona con pulsador

REGULADOR DE INTENSIDAD TRIAC - DALI CONTR-115



Funciona con pulsador

REGULADOR DE INTENSIDAD PULSABLE DALI CONTR-116



\* Según la nueva normativa ERP ha habido un cambio en la medición de Lúmenes y vatios, pero sigue emitiendo la misma cantidad de luz. A medida que vayan entrando los nuevos modelos con ERP se irá actualizando en catálogo y cajas de color. Puede haber variación respecto a la caja del producto (comprobar en ficha técnica), todos los datos en catálogo están correctos salvo error tipográfico.



## Pastillas para persiana



Válido para motores de 2 fases, 1 neutro y tierra

PASTILLA INTERRUPTOR DE PERSIANAS **WIFI + RF433** CONTR-068 49,80€



tuya

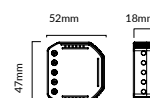

CONTR-069 (1 CANAL)    CONTR-070 (9 CANALES)

MANDO PARA PASTILLA CONTR-068 **1 PERSIANA** CONTR-069 18,84€

MANDO PARA PASTILLA CONTR-068 **HASTA 9 PERSIANAS** CONTR-070 35,70€



Válido para motores de 2 fases, 1 neutro y tierra

PASTILLA INTERRUPTOR DE PERSIANAS **WIFI** CONTR-045 54,00€



tuya

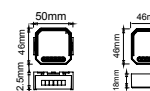



## Pastillas para puerta de garaje



Incluido finales de carrera

PASTILLA INTERRUPTOR PUERTA GARAGE

WIFI

CONTR-053

79,08€



tuya

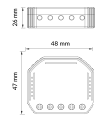

NEW!



Incluido finales de carrera

PASTILLA INTERRUPTOR PUERTA GARAGE

WIFI

CONTR-111

87,48€



tuya

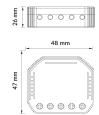

Máximo hasta 100uds

Accesorio control remoto push  
CONTR-107

CONTR-112 10,20€

## Pastillas para cerradura electrónica

Solo para cerraduras electrónicas



Potencia más de 2300 W

Persianas de garaje, puertas correderas y cerraduras electrónicas

PASTILLA PULSADOR PARA CERRADURAS ELECTRÓNICAS

WIFI

CONTR-056

41,58€



tuya

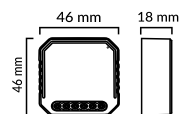

## Serie enchufe inteligente

- Compatible con los principales sistemas de control por voz
- Te permite programar múltiples encendidos.
- Control de consumo energético (instantáneo, mensual y anual)



NEW!



### Control remoto

ENCHUFE INTELIGENTE SMART 16A WIFI ACLED-121



tuya



ENCHUFE INTELIGENTE SMART CON LUZ 10A WIFI ACLED-092 43,17€



tuya

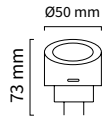

ENCHUFE INTELIGENTE SMART 16A WIFI ACLED-121 28,56€



tuya

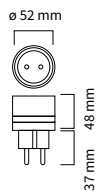

NEW!



ENCHUFE INTELIGENTE SMART EXTERIOR 16A WIFI ACLED-306



tuya



ENCHUFE INTELIGENTE SMART DOBLE BLANCO 2x16A WIFI ACLED-133 53,85€



tuya

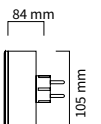

### Carga rápida USB

REGLETA INTELIGENTE SMART 10A x 3 tomas + 4usb x 2A WIFI ACLED-110 72,06€



tuya

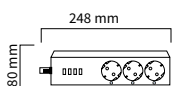



Con el interruptor inteligente puedes **apagar y encender cualquier dispositivo**, desde lámparas hasta televisiones, aire acondicionado, estufas, calderas, etc ... Soporta hasta 16A de carga máxima.

El interruptor inteligente se conecta a la WiFi de su domicilio, y con la app Tuya (gratuita para Android e iOS) instalada en tu teléfono móvil puedes controlar desde cualquier sitio si quieres encender o apagar el dispositivo que tengas conectado. Es compatible con redes WiFi.

El interruptor inteligente se conecta a la red eléctrica mediante un bloque terminal de entrada, y tiene otro bloque terminal de salida.

**Moderniza tu casa o tu negocio** de la forma más fácil y económica.



Corte de fase y neutro programable

INTERRUPTOR WIFI PROGRAMABLE	2200W max	10Ah max	CONTR-048	21,51€
  	↓		<b>tuya</b>	





Corte de fase y neutro programable

INTERRUPTOR WIFI PROGRAMABLE	3520W max	16Ah max	CONTR-451	34,92€
  	↓		<b>tuya</b>	



Corte de fase y neutro programable

INTERRUPTOR WIFI PROGRAMABLE	6600W max	30Ah max	CONTR-452	36,42€
  			<b>tuya</b>	

\* Según la nueva normativa ERP ha habido un cambio en la medición de Lúmenes y vatios, pero sigue emitiendo la misma cantidad de luz. A medida que vayan entrando los nuevos modelos con ERP se irá actualizando en catálogo y cajas de color. Puede haber variación respecto la caja del producto (comprobar en ficha técnica), todos los datos en catálogo están correctos salvo error tipográfico.

# Controla tu hogar desde 1 SOLO PUNTO



— Tecnología —  
**zigbee**

**Bajo consumo**  
Haciendo que las baterías de los productos domóticos duren mucho más.

- Funciona con nuestros módulos WiFi
- Alimentación por batería



**CR2430**  
CR2430 3V  
Batería no incluida

**1Año**  
1 Año autonomía

**1.3cm**  
espesor  
Fácil de transportar

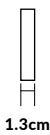

Control remoto



Ajustes escenas  
12 escenas



Botón mecánico



Uso interior

INTERRUPTOR INTELIGENTE 12 ESCENAS



Ref: **CONTR-093**  
PVPR: **81,96€**

COMPATIBLE CON APP **tuya**

**FÁCIL INSTALACIÓN**  
Montaje en superficie con adhesivo

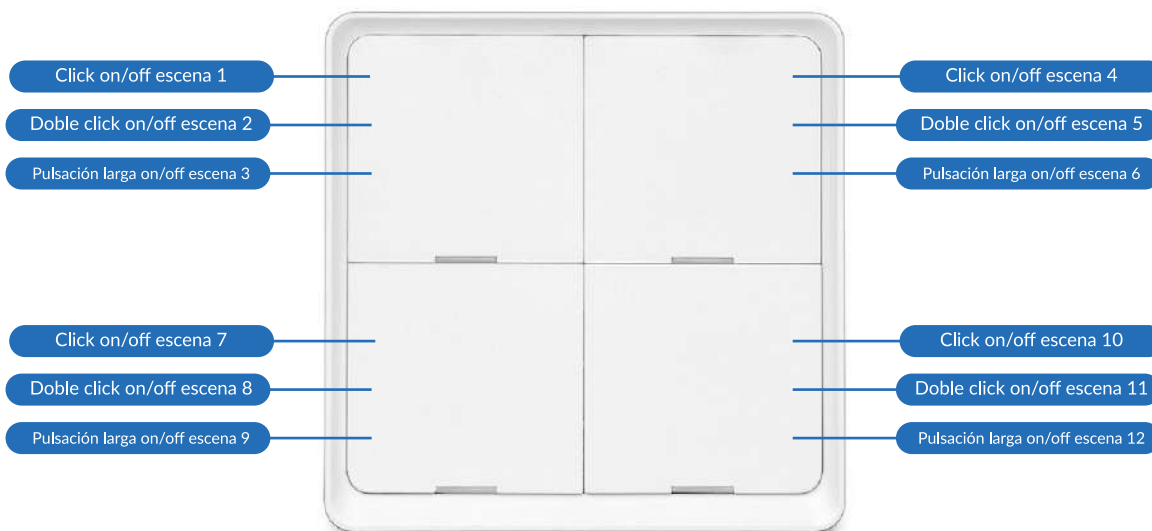

1 Interruptor  
**12 ESCENAS 4 AMBIENTES**



Aseo



Cocina



Sala de estar



Dormitorio



Cada botón tiene **3 modos de vinculación**  
**12 escenas**



**4 botones**  
pueden ser  
individuales



**3 métodos**  
de presión



**Elegir dispositivos**  
inteligentes de  
vinculación o control

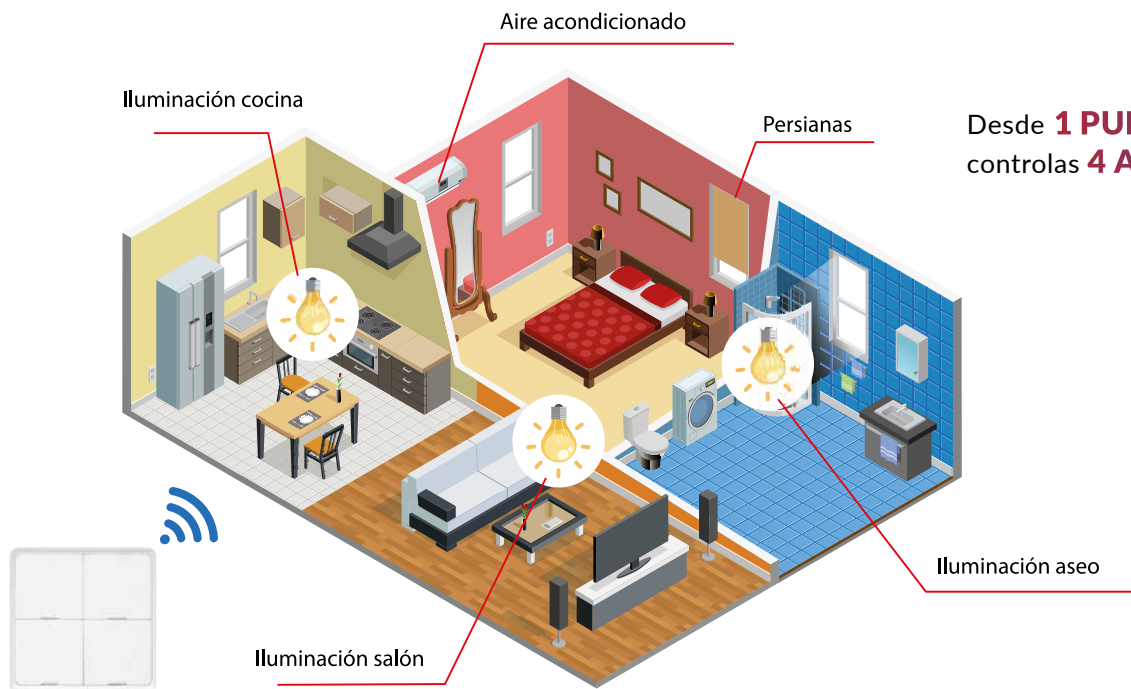

Desde **1 PUNTO**  
controlas **4 AMBIENTES**

## Puerta de enlace Gateway

**Control hasta**  
**128 dispositivos**



La puerta de enlace multimodo admite comunicación multiprotocolo Wi-Fi+Bluetooth+Zigbee. La malla Bluetooth (SIG) y la comunicación Zigbee garantizan un control estable de 128 dispositivos. La puerta de enlace implementa la comunicación entre la nube y los teléfonos móviles a través de Wi-Fi. Los dispositivos Zigbee y Bluetooth mesh (SIG) conectados se pueden ver y controlar de forma remota mediante la aplicación.

Además, los usuarios pueden implementar las funciones de agregar y restablecer dispositivos, control de terceros y control de grupos de subdispositivos. Esas características pueden cumplir con los requisitos de escenarios diversificados de hogares inteligentes



	Ref	PVPR
PUERTA DE ENLACE GATEWAY	tuya	CONTR-094 64,23€

\* Según la nueva normativa ERP ha habido un cambio en la medición de Lúmenes y vatios, pero sigue emitiendo la misma cantidad de luz. A medida que vayan entrando los nuevos modelos con ERP se irá actualizando en catálogo y cajas de color. Puede haber variación respecto a la caja del producto (comprobar en ficha técnica), todos los datos en catálogo están correctos salvo error tipográfico.

# Interruptor *inalámbrico*

**Añade un interruptor fácilmente donde quieras SIN NECESIDAD DE CABLEADO**

**Kit 2 Interruptores RF Switch + pastilla WiFi**



Interruptor RF sin cableado



Sin pilas o batería



Protección del medio ambiente



Ahorro de energía



Fácil instalación



Pastilla con memoria



Se puede añadir varios interruptores

TECNOLOGÍA **KINETIC**



**APP CONTROL REMOTO**

COMPATIBLE CON APP **tuya**

**2 MODOS DE CONTROL**  
WIFI + CONTROLADOR RF 433MHZ



• **Múltiples interruptores sin acoplarse.**

• **Controla el encendido apagado a distancia ON/OFF**

**Programa horarios**



# APLICACIONES



## Jardín

La solución minimalista para la iluminación del jardín.

## Exterior

Controla la iluminación sin necesidad de moverte.



## Sin contacto

Aplicación del interruptor sin contacto para hospitales.

## Aseos

Añade interruptor en tu aseo, sin quitar o cambiar azulejos.  
**Sin necesidad de obras**



PASTILLA WIFI y 2 INTERRUPTORES INALÁMBRICOS RF 16A CONTR-081 70,32€



tuya

16A



**NO NECESITA PILAS O BATERÍA**



**FÁCIL INSTALACIÓN**  
Montaje en superficie con adhesivo

Interruptor x2

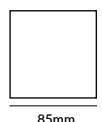

Pastilla

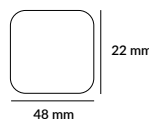

- **Simplicidad y comodidad** con un solo clic.
- **Pastilla codificada.** Posibilidad de instalar varias instalaciones sin acoplarse.
- **Compatible** con los principales sistemas de **control por voz.**



ESCANEA PARA  
DESCARGAR  
FICHA TÉCNICA

## Serie aire acondicionado



**CONTROL PROGRAMABLE SEMANAL**

**APAGADO CON MEMORIA**

**MODO MÚLTIPLES MODOS DE TRABAJO**

**VINCULACIÓN RÁPIDA Y SENCILLA**

2 pilas AAA - linterna piloto led

Ref PVPR

MANDO UNIVERSAL AIRE ACONDICIONADO PROGRAMABLE 1000 CÓDIGOS CONTR-084 20,70€



**1000** CÓDIGOS **EN 1**  
MAYOR COMPATIBILIDAD

**99%** Compatible con el 99% de las marcas



CONTR-090

## Control remoto aire acondicionado

Controla el aire acondicionado de forma remota desde tu smartphone APP

CONTROL REMOTO WIFI Aire Acondicionado Con pantalla **WIFI** CONTR-090 94,35€



4 Modos velocidad



5 Modos temperatura



Modo ECO



Historial de temp



Programar horario



Modo comfortable



Aviso cambio filtro de aire

tuya



CONTR-091

CONTROL REMOTO WIFI Aire Acondicionado **WIFI** CONTR-091 59,55€



4 Modos velocidad



5 Modos temperatura



Modo ECO



Historial de temp



Programar horario



Modo comfortable



Aviso cambio filtro de aire

tuya

### Controla la

- Temperatura
- On/Off
- Programa horarios
- Historial de temp

# Control remoto Wi-Fi

Controla a distancia desde tu smartphone cualquier electrodoméstico

COMPATIBLE CON APP **tuya**

## Sistema IR

### Control remoto WiFi



CONTROL REMOTO WIFI IR + RF **WIFI** Ref: CONTR-085 PVPR: 44,85€

- 210° ROTACION: Rotación 210°
- Control por APP
- Control por voz
- USB
- Link
- Escena personalizada



CONTROL REMOTO WIFI IR + RF con cable USB **WIFI** Ref: CONTR-086 PVPR: 46,35€

CONTROL REMOTO WIFI IR + RF cable USB y pantalla TEMP/HUM **WIFI** Ref: CONTR-087 PVPR: 39,90€

**tuya**

### Control remoto con SENSOR TEMPERATURA / HUMEDAD



CONTR-088

CONTROL REMOTO WIFI IR **WIFI** Ref: CONTR-088 PVPR: 55,14€

- Sensor de temp
- Sensor de humedad
- Control por voz

**tuya**



CONTR-089

CONTROL REMOTO PRO WIFI IR **WIFI** Ref: CONTR-089 PVPR: 86,70€

- Sensor de temp
- Sensor de humedad
- Control por voz
- Botón táctil
- Modo IR

**tuya**

### Especial para Aire acondicionado y Televisores



CONVERTIDOR WIFI A IR **7-10mts 300mA 2.4Ghz 360°** Ref: CONTR-047 PVPR: 35,94€

- 24v
- 1
- WIFI
- IR

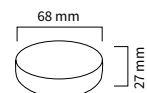

2,4/5,8 GHz - 1200Mbps  
3 modos de uso: Repetidor, router, modo AP

REPETIDOR WIFI DOBLE BANDA Ref: ACLED-161 PVPR: 130,17€

- 24v
- 1
- WIFI



MEDIDAS: 172x75x52mm  
GIRO ANTENAS: 180°

\* Según la nueva normativa ERP ha habido un cambio en la medición de Lúmenes y vatios, pero sigue emitiendo la misma cantidad de luz. A medida que vayan entrando los nuevos modelos con ERP se irá actualizando en catálogo y cajas de color. Puede haber variación respecto a la caja del producto (comprobar en ficha técnica), todos los datos en catálogo están correctos salvo error tipográfico.



## Serie sensores domóticos



Al detectar que se abre la puerta o la ventana se dispara la alarma

Programar temporizador para Activar/Desactivar la conexión

## SENSORES domóticos

Protege tu vivienda de la manera más **RÁPIDA** y **FÁCIL DE CONECTAR**.

Envío de notificaciones al smartphone



Compatible con **tuya**

### SENSORES PUERTA



Pilas AAA (2\*1.5V) No incluidas

ALARMA SEGURIDAD SENSOR PUERTA **CON SONIDO**

WiFi

Ref  
SGR-018

PVPR  
40,44€



100dB



Pilas AAA (2\*1.5V) No incluidas

ALARMA SEGURIDAD SENSOR PUERTA **SIN SONIDO**

WiFi

Ref  
SGR-012

PVPR  
31,20€





## BOTÓN SOS



BOTÓN WIFI SOS TUYA

SGR-046 20,94€



Batería  
3.7v / 400mAh



USB TIPO C

COMBINACIONES



BOTÓN WIFI SOS TUYA

SGR-038 47,16€



Batería  
3.7v / 400mAh



USB TIPO C



5cm

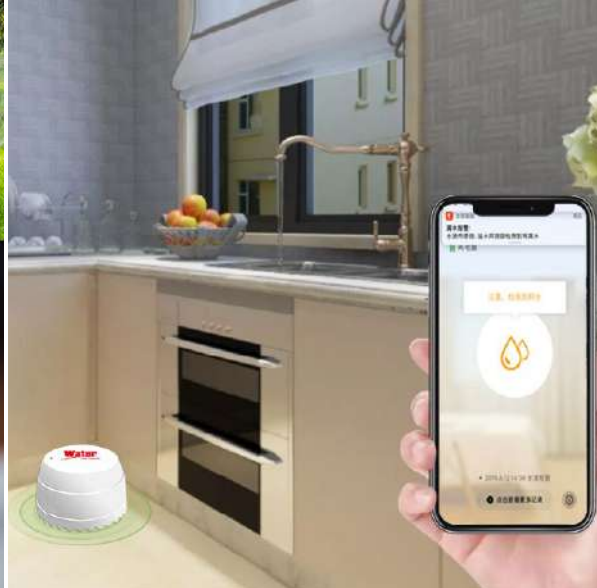



**Detecta y envía notificaciones** de posibles fugas de agua y cierra la válvula de agua de forma remota.

## SENSOR AGUA



		Ref	PVPR
ALARMA SEGURIDAD SENSOR FUGAS DE AGUA	WiFi	SGR-013	32,40€

-   · MONTAJE COLGADO EN PARED
- CON ADHESIVO O TORNILLOS (INCLUIDO)
- AAA PILAS ( INCLUIDAS )



Pilas AAA (2\*1.5V) Incluidas



ALARMA SEGURIDAD SENSOR FUGAS DE AGUA	WiFi	SGR-020	30,75€
---------------------------------------	------	---------	--------

-   · MONTAJE COLGADO EN PARED
- CON ADHESIVOS (INCLUIDO)
- AAA PILAS ( NO INCLUIDAS )



Pilas AAA (2\*1.5V) No Incluidas



ALARMA SEGURIDAD SENSOR FUGAS DE AGUA SUELO	WiFi	SGR-019	42,60€
---	------	---------	--------

-   MONTAJE EN EL SUELO



Pilas DC3V CR123A (Incluida)

· Cierra la válvula de agua de forma remota



CIERRE VALVULA WIFI	WiFi	SGR-023	71,10€
---------------------	------	---------	--------

-   Tiempo de cierre y apertura de la válvula 5-10 seg
- Válvula de palanca



Alimentación mediante transformador 230V/12V ( Incluido )



## ALARMA SENSOR PIR ((人))



Alimentación USB DC5V (Incluida)

**ALARMA SEGURIDAD SENSOR PIR**

WiFi

Ref

SGR-014

PVPR

41,70€



tuya

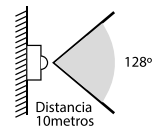

Alimentación USB DC5V (Incluida)

**ALARMA SEGURIDAD SENSOR PIR CON SONIDO ALARMA**

WiFi

SGR-025

56,25€



tuya

100dB

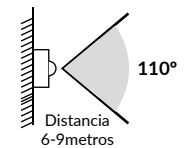

Pila 1 ud - CR17335/CR123A DC5V (Incluida)

**SENSOR DE MOVIMIENTO INTERIOR PORTATIL 3V**

WiFi

SGR-026

68,10€



tuya

LED AZUL SEÑAL DE ALARMA

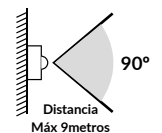

**Detección de movimiento SOLAR**

**Larga duración**



**Posibilidad de cargar con USB**



**SENSOR DE MOVIMIENTO SOLAR CON SONIDO ALARMA**

WiFi

SGR-022

59,85€



CARGA SOLAR O USB



tuya

SOLAR

120dB

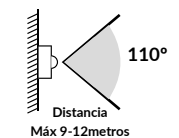

Control remoto por mando a distancia

- DETECCIÓN 12 Metros 120° Ángulo
- ALARMA 120dB
- DURACIÓN 20 seg





## SENSOR GAS



### CON SONIDO ALARMA

ALARMA SEGURIDAD SENSOR GAS NATURAL / METANO / BIOGAS

Ref	PVPR
WiFi SGR-021	65,58€



- DETECCIÓN DE GAS NATURAL / METANO / BIOGAS

80dB



tuya

Alimentación USB DC5V (Incluida)



### COLOCACIÓN ALARMA SEGURIDAD SENSOR GAS NATURAL / METANO / BIOGAS

Estos gases tienden a elevarse. La posición correcta es cerca del techo o en puntos altos. Aproximadamente a 30cm del techo.

Para más información consultar ficha técnica

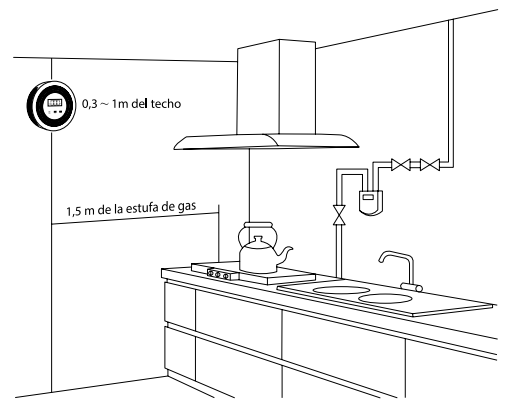

### CON SONIDO ALARMA

DETECTOR DE HUMO

Ref	PVPR
WiFi SGR-028	89,25€



85dB



tuya

Pila DC3V CR123A / CR17335 (Incluida)



### COLOCACIÓN DETECTOR DE HUMO

Debe ubicarse entre las áreas para dormir y las posibles fuentes de incendio, como salas de estar y cocinas. Debe colocarse en el centro del techo en una habitación

Para más información consultar ficha técnica

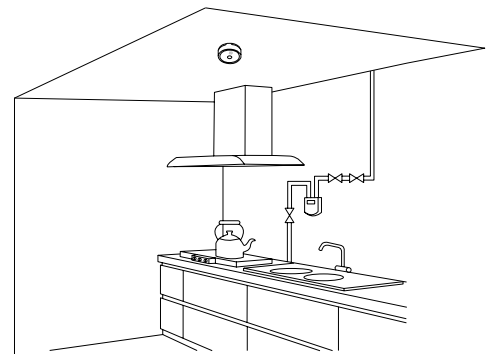



CON SONIDO ALARMA

DETECTOR DE MONÓXIDO DE CARBONO

WiFi

SGR-027

89,25€



85dB

Pilas DC3V AAA 2\*1.5V ( Incluidas )



tuya



### COLOCACIÓN DETECTOR DE MONÓXIDO DE CARBONO

Debe instalarse al nivel de los ojos, es decir a una altura de entre 1,5 y 1,7 metros y como máximo a 1 metro de la fuente de emisión.

Para más información consultar ficha técnica

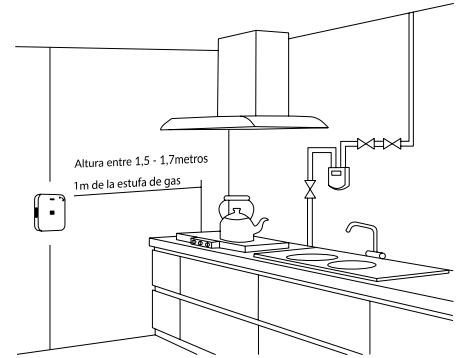



## Serie aire acondicionado

**CONTROLA LA TEMPERATURA A DISTANCIA  
DESDE TU SMARTPHONE O LA VOZ**

Termostato WiFi inteligente **tuya**, controlador de temperatura para **caldera de gas y termo eléctrico**.

TERMOSTATO CALDERA WIFI-TUYA  
CON ACCESORIO REMOTO

TERM-001 - 245,52€



COMPATIBLE  
CON APP

tuya

"Compatible con los principales asistentes de voz (asistente de Google\*, Amazon\*, Alexa\* ... etc.)"

COMPATIBLE  
CON SISTEMA  
DE VOZ

Alexa

Estas marcas son propiedad de sus respectivos propietarios, y como tal, son reconocidas por Atmos Electric Equipment S.L. y son utilizadas únicamente con fines enunciativos.



Funciona con Google Home.  
**SUPERFICIE**

**EL WIFI SOLO FUNCIONA CUANDO ESTÁ  
CONECTADO POR USB o a 230V**



Ficha técnica



Video vinculación

- Termostato WiFi inteligente **tuya**, controlador de temperatura para **suelo radiante**.



COMPATIBLE CON APP **tuya**

"Compatible con los principales asistentes de voz (asistente de Google\*, Amazon\*, Alexa\* ... etc.)"

COMPATIBLE CON SISTEMA DE VOZ **Alexa**

Estas marcas son propiedad de sus respectivos propietarios, y como tal, son reconocidas por Atmoss Electric Equipment S.L y son utilizadas únicamente con fines enunciativos.



**TERM-004**  
NEGRO



**TERM-004S - SYLVER**  
ACABADO ESPEJO

**Características:** [Instrucciones](#)

1. Sensor de temperatura: NTC
2. Precisión de temperatura: +- 1°C
3. Pantalla de visualización. LCD
4. Ambiente de trabajo: -5-50°C
5. Potencia de autoconsumo: <1w
6. Ajuste de temperatura: 5-60°C
7. Rango de visualización: 0-51°C
8. Corriente de carga: calentador eléctrico 16A (resistiva)
9. Tensión: AC100-240V, 50/60Hz

TERMOSTATO SUELO RADIANTE WIFI-TUYA

**TERM-004** - 107,25€

TERMOSTATO SUELO RADIANTE WIFI-TUYA SYLVER

**TERM-004S** - 107,25€



**CAJA PARA TERMOSTATO**  
**TERM-004**

**TERM-003** 3,72€

\* Según la nueva normativa ERP ha habido un cambio en la medición de Lúmenes y vatios, pero sigue emitiendo la misma cantidad de luz. A medida que vayan entrando los nuevos modelos con ERP se irá actualizando en catálogo y cajas de color. Puede haber variación respecto la caja del producto (comprobar en ficha técnica), todos los datos en catálogo estan correctos salvo error tipográfico.



- Termostato caldera WiFi inteligente **tuya**, controlador de temperatura para **caldera de gas y termo eléctrico**.



**"Compatible con los principales asistentes de voz (asistente de Google\*, Amazon\*, Alexa\* ... etc.)"**

*Estas marcas son propiedad de sus respectivos propietarios, y como tal, son reconocidas por Atmoss Electric Equipment S.L y son utilizadas únicamente con fines enunciativos.*

TERMOSTATO CALDERA WIFI-TUYA

TERM-006 - 119,16€



Características: Instrucciones

- |                                   |                                    |
|-----------------------------------|------------------------------------|
| 1. Fuente de alimentación:        | 100 ~ 240V                         |
| 2. Carga actual:                  | ≤3A (caldera)                      |
| 3. Consumo de energía:            | <1w                                |
| 4. Material externo:              | PC + ABS (retardante de llama)     |
| 5. Elemento sensor:               | CNT                                |
| 6. Establecer temperatura. Rango: | 5-95°C                             |
| 7. Temp. establecida del piso:    | 5-60°C                             |
| 8. Precisión del rango:           | ≤1°C                               |
| 9. Dimensión:                     | 86 x 90 x 14mm                     |
| 10. Temp ambiente:                | 0-45°C, 5-95%RH (sin condensación) |
| 11. Temp de almacenamiento:       | - 5 ~ 55°C                         |
| 12. Error de sincronización:      | <1%                                |

- Termostáto caldera WiFi inteligente **tuya**, controlador de temperatura para **caldera de gas y termo eléctrico**.



"Compatible con los principales asistentes de voz (asistente de Google\*, Amazon\*, Alexa\* ... etc.)"



Estas marcas son propiedad de sus respectivos propietarios, y como tal, son reconocidas por Atmoss Electric Equipment S.L y son utilizadas únicamente con fines enunciativos.

NEW!



**TERMOSTÁTO BOTÓN REGULABLE CALDERA WIFI-TUYA**

**TERM-007 - 133,98€**

**Características:**

**Instrucciones**

- |                              |                                |
|------------------------------|--------------------------------|
| 1. Alimentación:             | 3 pilas AAA - USB C            |
| 2. Carga actual:             | ≤3A (caldera)                  |
| 3. Material externo:         | PC + ABS (retardante de llama) |
| 4. Elemento sensor:          | CNT                            |
| 5. Temperatura de control:   | 5 - 95°C                       |
| 6. Temperatura mínima        | 0,5°C                          |
| 7. Precisión del rango:      | ≤1°C                           |
| 8. Dimensión:                | 86 x 90 x 14mm                 |
| 9. Temp de trabajo:          | - 15 ~ 40°C                    |
| 10. Error de sincronización: | <1%                            |
| 11. Grado de protección:     | IP20                           |

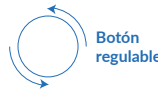

- Válvula regulable WiFi inteligente **tuya**, controlador de temperatura para radiadores.



"Compatible con los principales asistentes de voz (asistente de Google\*, Amazon\*, Alexa\* ... etc.)"



Estas marcas son propiedad de sus respectivos propietarios, y como tal, son reconocidas por Atmoss Electric Equipment S.L y son utilizadas únicamente con fines enunciativos.

VÁLVULA REGULABLE PARA RADIADORES WIFI-TUYA

**TERM-005 - 165€**

NEW!



**Características:**

**Instrucciones**

- Alimentación: 3 x 1.5V alcalina AA Batería (no incluida)
- Corriente: 64A
- Protección: IP20
- Temperatura: 0-50°C
- Temperatura de la superficie: 90°C Máx
- Conexión: M30 x 1.5mm
- Recorrido lineal: 6mm
- Dimensiones: 59.4 x 99.3 x 59.4 mm
- Peso: 145gr

\* Según la nueva normativa ERP ha habido un cambio en la medición de Lúmenes y vatios, pero sigue emitiendo la misma cantidad de luz.

A medida que vayan entrando los nuevos modelos con ERP se irá actualizando en catálogo y cajas de color.

Puede haber variación respecto a la caja del producto (comprobar en ficha técnica), todos los datos en catálogo están correctos salvo error tipográfico.

## Serie sistemas de seguridad

### ALARMA

#### KIT DE ALARMA SEGURIDAD



tuya

Compatible con los principales sistemas de control por voz

Ref SGR-001  
PVPR 144,27€

#### Contenido de la caja:

- 1u alarma
- 1u mando auxiliar
- 1u sensores movimiento
- 1u cargador USB
- 3u sensores puertas/ventana

**ADMITE HASTA 25  
ACCESORIOS ENLAZADOS**

#### Accesorios compatibles con nuestro Kit de Alarma Atmoss con SGR-001

Sensor movimiento	Sensor puerta/ventana	Sensor agua	Timbre inalámbrico	Mando auxiliar
Ref SGR-002	Ref SGR-003	Ref SGR-004	Ref SGR-005	Ref SGR-006
PVPR 18,75€	PVPR 12,96€	PVPR 28,22€	PVPR 11,22€	PVPR 9,45€

## Kit Sistema de seguridad GSM

- Compatible con los principales sistemas de control por voz.
- Tecnología GSM:

tuya



Conecta la alarma con el número telefónico programado previamente por el propietario, para informar de lo sucedido en el hogar por medio de un mensaje (SMS). La alarma de seguridad no dejará de sonar hasta que el usuario no de respuestas al sistema, indicando que todo se encuentra bien.

**KIT SEGURIDAD PANEL + SENSOR MOVIMIENTO + MANDO. CON TARJETA SIM - SGR-024**

Ref

PVPR

243,45€



### Sistema de alarma

- Acabado moderno
- Resistente al agua y polvo
- Teclado táctil
- WiFi
- Tecnología GSM (Admite tarjeta SIM)

### Incluye



Detector de movimiento PIR

Ref SGR-037  
PVPR 20,04€



Sensor puerta / ventana

Ref SGR-036  
PVPR 10,08€



Mando inalámbrico

Ref SGR-035  
PVPR 12,36€



Llave RFID



Sirena

### Accesorio



### Añade al sistema de alarma

ALARMA SOLAR EXTERIOR PARA SGR-024

Ref SGR-040

PVPR 74,10€



WiFi



GSM (Tarjeta SIM)



Teclado táctil



SMS / Llamada alerta



Llave RFID

SOS

SOS



App mensaje push



Diferentes idiomas

# CERRADURA INTELIGENTE

**Libertad y seguridad**  
 Bloquea/Desbloquea tu  
 puerta a distancia

Envío de notificaciones  
 al smartphone

Compatible con

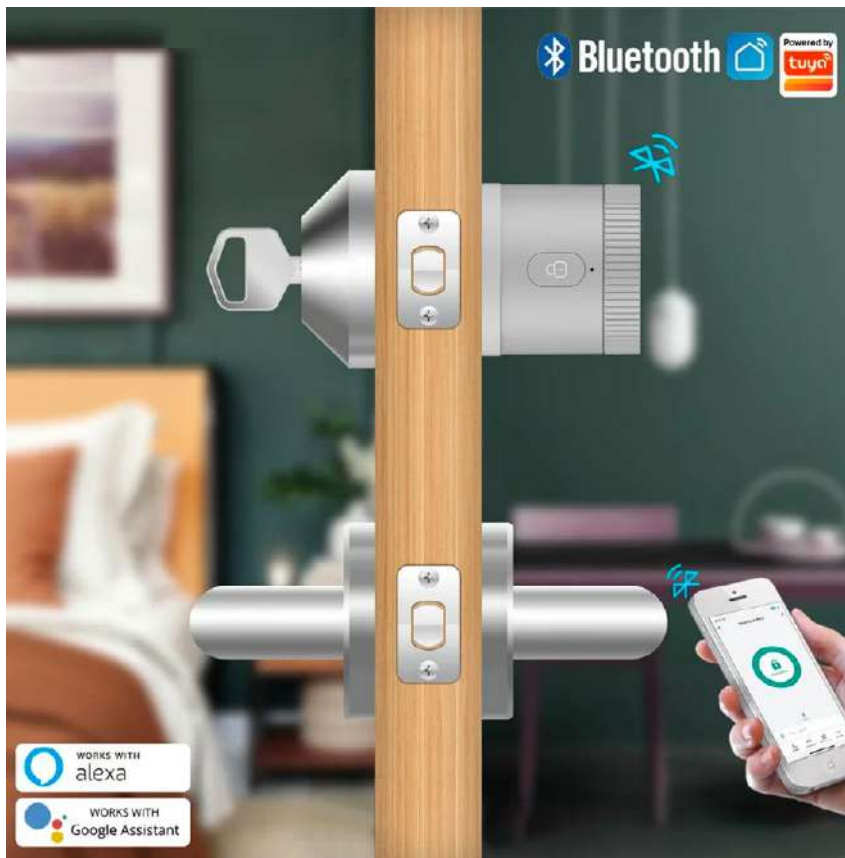

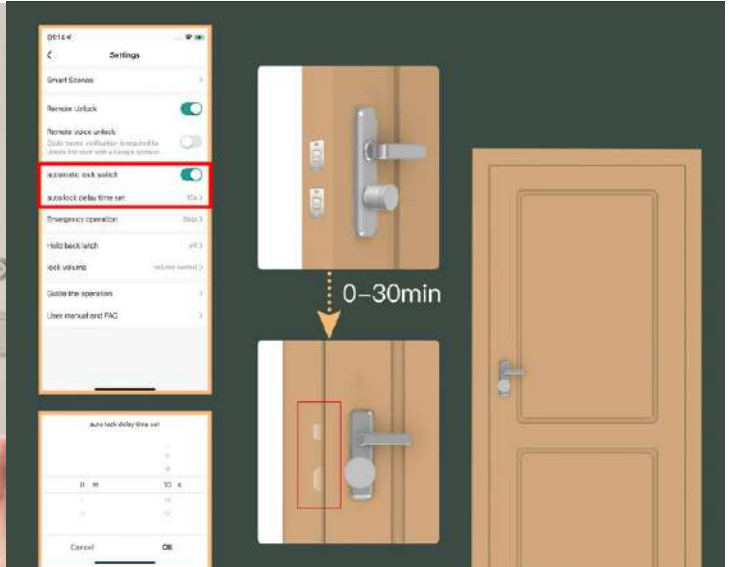

**Desbloqueo/Bloqueo temporal con Hora**

Añada la cuenta de Tuya para el desbloqueo temporal por otros como uso compartido del dispositivo.



Ajuste el tiempo de retraso para el bloqueo automático. Bloquear automáticamente la puerta cuando se desbloquea dentro del tiempo establecido.

**Instalación sencilla en 10 minutos sin perforar**

- 1. Funciona con 4 pilas AA con 6 meses de autonomía.
- 2. Cifrado con encriptación grado bancario AES128 bit y encriptación TLS.
- 3. Protocolo BLE de bajo consumo
- 4. Tamaño compacto con instalaciones sencillas en minutos.

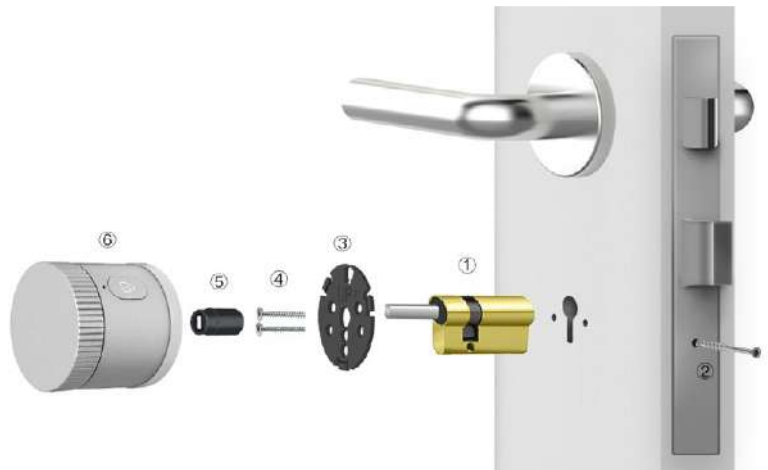

	Ref	PVPR
CERRADURA INTELIGENTE	SGR-039	223,41 €

Puerta de enlace Gateway no incluido - Pilas no incluidas



**Necesario incluir**  
Puerta de enlace Gateway



	Ref	PVPR
PUERTA DE ENLACE GATEWAY	CONTR-094	64,23 €



\* Según la nueva normativa ERP ha habido un cambio en la medición de Lúmenes y vatios, pero sigue emitiendo la misma cantidad de luz. A medida que vayan entrando los nuevos modelos con ERP se irá actualizando en catálogo y cajas de color. Puede haber variación respecto a la caja del producto (comprobar en ficha técnica), todos los datos en catálogo están correctos salvo error tipográfico.



Envío de notificaciones al smartphone 

Compatible con **tuya**



## CERRADURA INTELIGENTE SGR-048

**Instalación muy sencilla**  
Accede sin llaves con total seguridad

**Pestillo ajustable**  
60-70mm

Compatible con la mayoría de cerraduras de embutir

**Puertas**  
35-50mm

Compatible con las puertas de 35-50 mm

**Gran distancia**  
Apertura desde App

Hasta 15m sin obstáculos



## 5 FORMAS DE APERTURA



Huella dactilar



Más contraseñas: temporales y permanentes



Tarjeta (x 2uds)



Llave (x 2uds)

Transporte no incluido. Para más información y descarga de fichas técnicas - [www.atmoss.es](http://www.atmoss.es) -

TODOS LOS PRECIOS SON EN PVPR Y ESTÁN SUJETOS A MODIFICACIONES. LOS PRECIOS ESTÁN CORRECTOS SALVO ERROR TIPOGRÁFICO, EN ÚLTIMA INSTANCIA COMPROBAR EN TARIFA DE PRECIOS - COMPROBAR MEDIDAS CON EL ARTICULO EN FÍSICO YA QUE PUEDE HABER ERROR TIPOGRÁFICO



Orientación válida para Izquierda o derecha

Izquierda

Derecha

### ● Apertura de puerta

Presiona el botón en la manilla interior durante 2 segundos y la cerradura se quedará abierta.

Cualquiera podrá abrir la puerta sin contraseña ni huella.

Presiona el botón en la manilla interior nuevamente durante 2 segundos para desactivar el modo.



### FÁCIL DE USAR



ESCANEAR PARA VER VIDEO INSTALACIÓN



MANUAL DE INSTRUCCIONES



CERRADURA INTELIGENTE

tuya



Ref  
SGR-048

PVPR

Funciona con Pilas (No incluidas)

Series **videoportero**  
con monitor 7"

**MONITOR  
INCLUIDO**

**1080P**  
FULL HD



Exterior



Interior

**FACILIDAD DE  
INSTALACIÓN**  
**MEDIANTE  
2 HILOS SIN  
POLARIDAD**

Envío de notificaciones  
al smartphone



Compatible con **tuya**

- FÁCIL INSTALACIÓN
- 2 HILOS SIN POLARIDAD
- SISTEMA TÁCTIL
- ALTA TECNOLOGÍA



TÁCTIL

1080P

7"  
PULGADAS



ADMITE TARJETA  
MICRO SD



FUENTE DE  
ALIMENTACION  
INCLUIDA



TARJETA RFID  
INCLUIDA



WIFI

COMPATIBLE  
CON **tuya**

ALUMINIO

CAMARA  
VISION  
NOCTURNA

ALTA GAMA · ELEGANTE · CONECTIVIDAD



AÑADE LA **CUBIERTA  
PROTECTORA** A TU  
INSTALACIÓN PARA  
HACERLO MÁS SEGURO  
EN EL EXTERIOR

Ref VPO-COVER

Compatible con **tuya**



	Ref
VIDEOPORTERO CON MONITOR 7" 1080P <b>WiFi Tuya tuya</b>	VPO-001



**ACCESORIOS** Ref  
MONITOR 7" PARA VPO-001 VPO-001P

· Poner fuente alimentación para cada pantalla  
**Compatible hasta 4 pantallas**

Compatible con **tuya**



	Ref
Videoportero Negro - Monitor 7"	
VIDEOPORTERO CON MONITOR 7" 1080P <b>WiFi Tuya tuya</b>	VPO-002



**ACCESORIOS** Ref  
MONITOR 7" PARA VPO-001 VPO-002P

· Poner fuente alimentación para cada pantalla  
**Compatible hasta 4 pantallas**

Compatible con **tuya**



	Ref
Videoportero Gris - Monitor 7"	
VIDEOPORTERO CON MONITOR 7" 1080P <b>WiFi Tuya tuya</b>	VPO-003



**ACCESORIOS** Ref  
MONITOR 7" PARA VPO-001 VPO-002P

· Poner fuente alimentación para cada pantalla  
**Compatible hasta 4 pantallas**

**No Wifi**



	Ref
Videoportero Gris - Monitor 7"	
VIDEOPORTERO CON MONITOR 7" 1080P	VPO-004

**No Wifi**



	Ref
Videoportero Negro - Monitor 7"	
VIDEOPORTERO CON MONITOR 7" 1080P	VPO-005

**No Wifi**



	Ref
Videoportero Aluminio - Monitor 7"	
VIDEOPORTERO CON MONITOR 7" 1080P	VPO-006



Serie timbres



Posición horizontal

TIMBRE DING DONG 230V Blanco Ref: TIMB-001 PVPR: 7,56€

85dB Sonido Ding-Dong



Posición vertical DISEÑO MODERNO

TIMBRE DING DONG 230V Blanco Ref: TIMB-002 PVPR: 8,94€

90dB Sonido Ding-Dong



Posición vertical

TIMBRE DING-DONG Blanco Ref: TIMB-395 PVPR: 8,94€

80dB Sonido Ding-dong



Volumen REGULABLE 30-80dB 38 sonidos

TIMBRE DING-DONG Blanco Ref: TIMB-393 PVPR: 18,54€

30-80dB 38Sonidos



TIMBRE DING-DONG Blanco Ref: TIMB-394 PVPR: 13,92€

80dB Sonido Ding-dong



			Ref	PVPR	
TIMBRE BUZZER	30W	220V-240V	SONIDO ZUMBADOR	TIMB-004	5,55€



NEW!



5 llaves digitales incluidas

			Ref	PVPR
TECLADO CONTROL NUMÉRICO ACCESO PUERTA APP TUYA			SGR-041	104,85€



- Admite 2000 usuarios
- Velocidad de funcionamiento rápida, <20ms con 2000 usuarios
- Admite tarjeta, PIN, tarjeta+PIN
- Teclas retroiluminadas
- Tiempo de apertura de puerta ajustables
- Protección contra cortocircuitos
- Fácil de instalar y programar
- Admite 200 llaveros



			Ref	PVPR
FUENTE DE ALIMENTACIÓN 12V			SGR-042	48,45€



			Ref	PVPR
TIMBRE 12V ABS SONIDO DING DONG BLANCO			TIMB-399	18,30€



\* Según la nueva normativa ERP ha habido un cambio en la medición de Lúmenes y vatios, pero sigue emitiendo la misma cantidad de luz. A medida que vayan entrando los nuevos modelos con ERP se irá actualizando en catálogo y cajas de color. Puede haber variación respecto a la caja del producto (comprobar en ficha técnica), todos los datos en catálogo están correctos salvo error tipográfico.



## Timbre *TIMB-398* con cámara



### Videollamada en directo hable con los visitantes a la vez

Quando el visitante pulse el timbre, se enviará una notificación a su teléfono móvil, puede responder y entrar en la interfaz de videollamada. Admite un máximo de 10 miembros de la familia.

TIMBRE EXTERIOR INALÁMBRICO WIFI  
**CÁMARA BOTÓN Y ACCESORIO TIMBRE**

· COMPATIBLE CON LA APP PROPIA  
· NO COMPATIBLE CON TUYA

USO INTERIOR/  
EXTERIOR

TIMB-398 50,52€

## Fácil instalación

Con adhesivo o tornillo

Pegamento adhesivo 3M  
Fijación física con tornillos



## VISIÓN NOCTURNA ALTA DEFINICIÓN

Función de visión nocturna por infrarrojos.  
Conmutación automática día/noche





**TIMBRE INALÁMBRICO  
KINETIC - SIN BATERÍA**  
TIMB-396

DIFERENTES  
COMBINACIONES  
ENTRE TIMBRES  
KINETIC



38 Sonidos



4 Niveles  
volumen



Protección  
impermeable  
IP44



230v Receptor



Distancia larga  
(Hasta 150mts)



Señal fuerte

**TIMBRE EXTERIOR INALÁMBRICO  
KINETIC BOTÓN Y ACCESORIO TIMBRE**

TIMB-396 33,24€  **SISTEMA RF - NO FUNCIONA  
POR WIFI**



**USB TIMBRE INALÁMBRICO**  
TIMB-397



38 Tones



3 Niveles  
volumen



USB interface  
receptor enchufe



Amplio rango  
de trabajo



Fuerte  
penetración

**TIMBRE EXTERIOR INALÁMBRICO CON  
BATERIA BOTÓN Y ACCESORIO TIMBRE**

TIMB-397 17,46 €  **SISTEMA RF - NO FUNCIONA  
POR WIFI**

**Diferentes combinaciones**

Puedes añadir uno o más receptores al pulsador.  
O viceversa. Añadir varios pulsadores  
con el mismo receptor.



36 Tones



100-120 metros  
(distancia abierta)



Señal LED



**TIMBRE DING DONG 230V  
INALÁMBRICO CON BOTÓN**

Ref  
TIMB-003 PVPR  
22,56€



Batería  
12V  
23A



Bajo  
Medio  
Alto



38 Tones



Rango de  
distancia  
80mts



TIMBRE CON SENSOR DE MOVIMIENTO POR INFRARROJOS  
**RECEPTOR + SENSOR**

Ref	PVPR	↓
SGR-015	40,44€	

**CONEXIÓN**

- EL SENSOR UTILIZA 3 PILAS AAA
- EL EMISOR SE CONECTA A 230V AL ENCHUFE



ALTAVOZ DEL TIMBRE  
PARA SENSOR SGR-016

Ref	PVPR
SGR-017	24,36€



SENSOR DE MOVIMIENTO  
PARA TIMBRE SGR-017

Ref	PVPR
SGR-016	16,08€

SE PUEDE VENDER POR SEPARADO

- RANGO DE TRABAJO DE 100 METROS ENTRE RECEPTOR Y EMISOR

Ideal para **puertas de entrada, marcos de ventanas, entradas de vehículos, caminos peatonales** y cualquier lugar de su casa en el que desee recibir una alerta de movimiento. También es ideal para alertar a los propietarios de negocios que están trabajando en la parte trasera, o fuera de la vista, a los clientes que entran en su tienda.

**SERIE COMBINABLE  
HASTA 32 ELEMENTOS**

POSIBILIDAD DE AÑADIR  
VARIOS TIMBRES Y SENSORES



**IDEAL PARA PUERTAS, TIENDAS,...**



Rotación



100m  
Distancia



IP65  
Impermeable



38  
Melodías





## TIMBRE CON CÁMARA WIFI TUYA CON BATERÍA

	Ref	PVPR
TIMBRE CON CÁMARA WIFI TUYA CON BATERÍA	SGR-010	239,85€



1080P HD Video



Dos canales audio



Visión nocturna



166° Ángulo lente



Sensor de movimiento PIR



Gran autonomía hasta 6 meses



Espacio para tarjeta de memoria hasta 64Gb



DESCARGAR  
Ficha técnica



+ CABLE FLAT DE CARGA  
ULTRASLIM FLEXIBLE

Carga por USB con cable FLAT Ultraslim (Cable incluido) **Batería:** 4500mAh - 21700 - 7V

**6 MESES DE AUTONOMÍA**



AÑADE EL TIMBRE SGR-011  
PARA ESCUCHAR EL TIMBRE  
SIN NECESIDAD DE MOVIL



DESCARGAR  
Ficha técnica

Ref	PVPR
SGR-011	23,76€

Convierte tu timbre con cámara en **VIDEOPORTERO**

CON LA PASTILLA PULSADOR PARA CERRADURAS ELECTRÓNICAS **CONTR-056**



## VISUALIZADOR MIRILLA CON PANTALLA

ALIMENTACIÓN POR USB O PILAS AAA

\* NO DISPONE DE  
• WIFI / BLUETOOTH



MIRILLA DIGITAL CON PANTALLA

Ref	PVPR
SGR-009	109,80€

DESCARGAR  
Ficha técnica



Función timbre



Visión infrarrojo



Foto/video



AAA  
Batería  
(NO INCLUIDA)



Ángulo 166°



Fácil instalación



Función no molestar



Espacio para tarjeta micro SD  
(NO INCLUIDA)

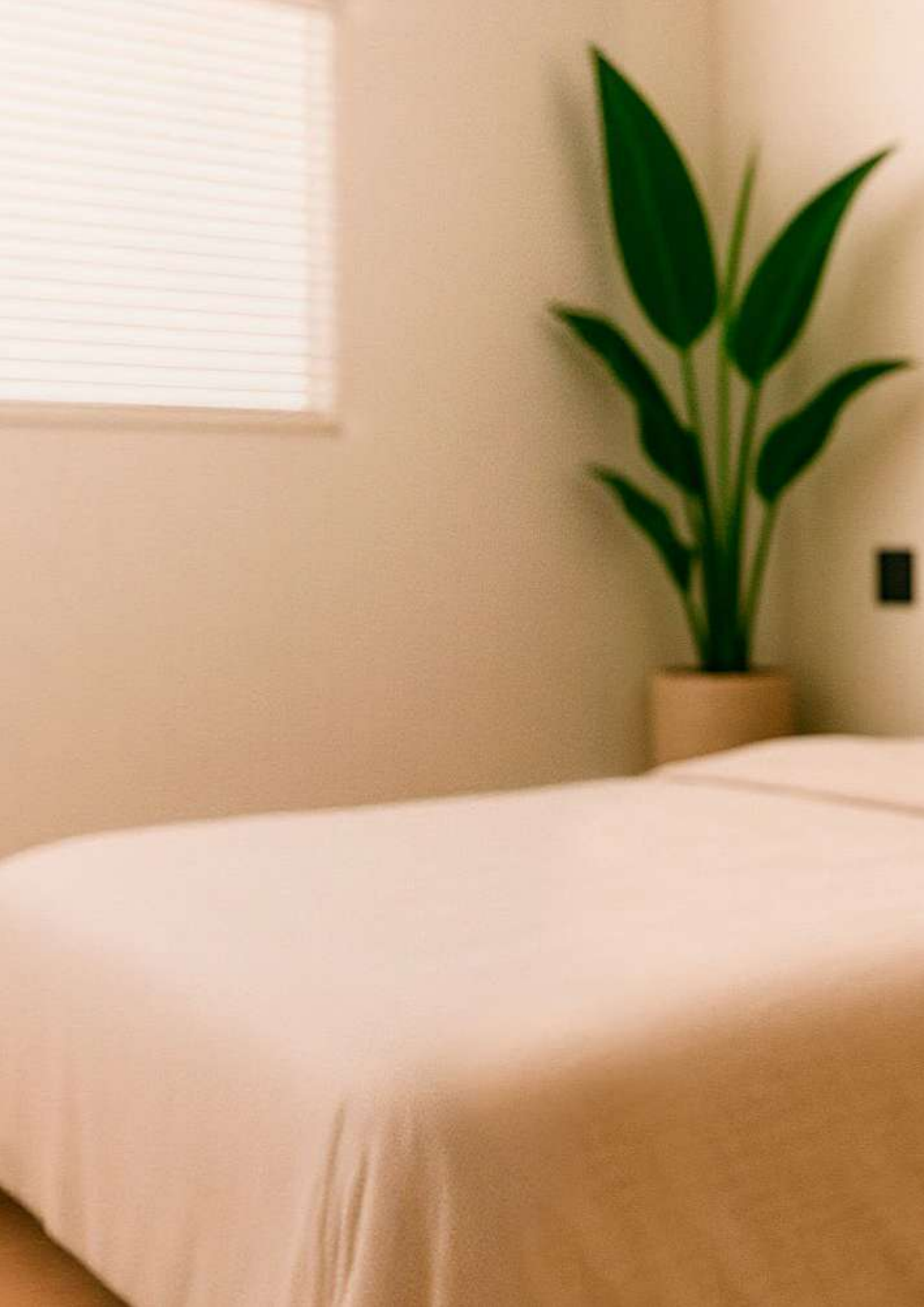

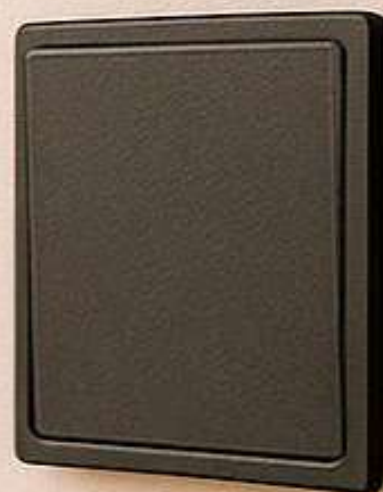

Serie Mecanismos 



# Dynamic S20

MECANISMOS

10 UDS

100 UDS

DESCARGAR  
FICHAS TÉCNICAS

Tecla.10 + Marco.10

Blanco.10



Tecla.10 + Marco.11

Aluminio.11



Tecla.11 + Marco.12

Antracita.12



Tecla.10 + Marco.20

Perla brushed .20



Tecla.10 + Marco.21

Aluminio brushed .21



\* Según la nueva normativa ERP ha habido un cambio en la medición de Lúmenes y vatios, pero sigue emitiendo la misma cantidad de luz.

A medida que vayan entrando los nuevos modelos con ERP se irá actualizando en catálogo y cajas de color.

Puede haber variación respecto la caja del producto (comprobar en ficha técnica), todos los datos en catálogo están correctos salvo error tipográfico.

**COMPATIBLE**

**SERIE COLOR ANTRACITA S20**

**TODOS NUESTROS MECANISMOS S20 SON COMPATIBLES CON LAS TECLAS S30 ANTRACITA**



S20.900.XX - Garra para mecanismo S20/S30



S20.901.XX - Piloto luminoso LED



S20.130.10 - Tapa base doble RJ45 Blanco



S20.101.XX - Interruptor  
S20.102.XX - Conmutador  
S20.107.XX - Cruzamiento  
S20.109.XX - Pulsador



S20.103.XX - Interruptor luminoso LED  
S20.110.XX - Pulsador luminoso LED  
S20.122.XX - Conmutador luminoso LED  
S20.124.XX - Cruzamiento luminoso LED

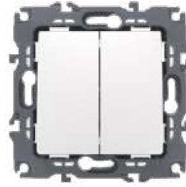

S20.104.XX - Interruptor doble  
S20.105.XX - Conmutador doble  
S20.136.10 - Conmutador + Cruzamiento



S20.106.XX - Interruptor doble luminoso  
S20.123.XX - Conmutador doble luminoso



S20.108.XX - Pulsador luminoso timbre led



S20.111.XX - Interruptor bipolar

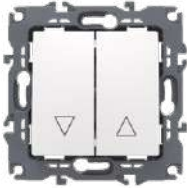

S20.120.XX - Interruptor de persianas  
S20.134.10 - Pulsador doble para persiana



S20.112.XX - Base corriente Schuko 16A  
8 UDS  
80 UDS  
PROTECCIÓN INFANTIL



S20.114.XX - Base corriente Schuko 16A + 2 Base USB 2.1A  
6 UDS  
60 UDS  
PROTECCIÓN INFANTIL



S20.129.10 - Base corriente 16A + 2 USB Tipo A y C  
6 UDS  
60 UDS  
PROTECCIÓN INFANTIL  
**NEW!** CARGA RÁPIDA



S20.113.XX - Base doble USB 2.1A  
6 UDS  
60 UDS



S20.115.XX - Base teléfono RJ11 (CAT3)



S20.116.XX - Base red RJ45 (CAT6)



S20.133.XX - Base doble fibra óptica



S20.117.XX - Regulador giratorio



S20.118.XX - Tapa ciega



S20.121.XX - Tapa Universal TV + FM + SAT



S20.126.XX - Pulsador con símbolo luz



S20.127.XX - Pulsador con símbolo timbre



S20.128.XX - Pulsador luminoso con símbolo luz



S20.131.XX - Salida cables mecanismo



S20.132.XX - Timbre zumbador



S20.135.10 - Interruptor de tarjeta

Marco **BLANCO.10**

S20.301.10



20 UDS  
200 UDS

S20.302.10

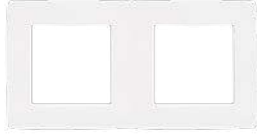

10 UDS  
100 UDS

S20.303.10



15 UDS  
150 UDS

S20.304.10

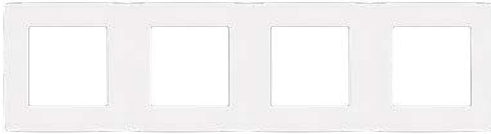

10 UDS  
100 UDS

Marco **ALUMINIO.11**

S20.301.11

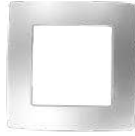

20 UDS  
200 UDS

S20.302.11

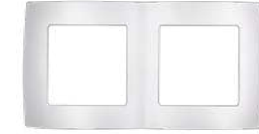

10 UDS  
100 UDS

S20.303.11



15 UDS  
150 UDS

S20.304.11



10 UDS  
100 UDS

Marco **ANTRACITA.12**

S20.301.12



20 UDS  
200 UDS

S20.302.12



10 UDS  
100 UDS

S20.303.12



15 UDS  
150 UDS

S20.304.12



10 UDS  
100 UDS

Marco **PERLA BRUSHED.20**

S20.301.20



20 UDS  
200 UDS

S20.302.20

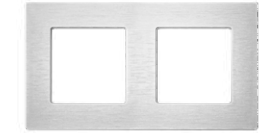

10 UDS  
100 UDS

S20.303.20

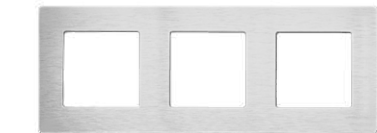

15 UDS  
150 UDS

S20.304.20

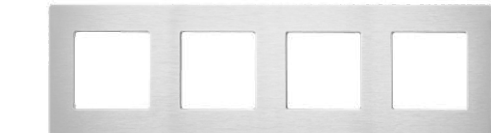

10 UDS  
100 UDS

Marco **ALUMINIO BRUSHED.21**

S20.301.21



20 UDS  
200 UDS

S20.302.21



10 UDS  
100 UDS

S20.303.21



15 UDS  
150 UDS

S20.304.21



10 UDS  
100 UDS

\* Según la nueva normativa ERP ha habido un cambio en la medición de Lúmenes y vatios, pero sigue emitiendo la misma cantidad de luz. A medida que vayan entrando los nuevos modelos con ERP se irá actualizando en catálogo y cajas de color. Puede haber variación respecto la caja del producto (comprobar en ficha técnica), todos los datos en catálogo están correctos salvo error tipográfico.

## Dynamic S20 SUPERFICIE



S20.201.10

ZOCALO SUPERFICIE 1 ELEMENTO/BLANCO S20

PVPR - 4,96€



S20.202.10

ZOCALO SUPERFICIE 2 ELEMENTO/BLANCO S20

PVPR - 8 €

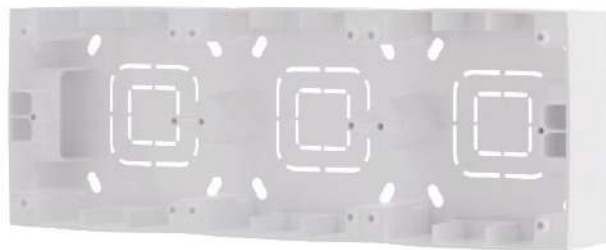

S20.203.10

ZOCALO SUPERFICIE 3 ELEMENTO/BLANCO S20

PVPR - 11,60 €



S20.204.10

ZOCALO SUPERFICIE 4 ELEMENTO/BLANCO S20

PVPR - 15,72 €



		Ref	PVPR
BASE DOBLE CORRIENTE 16A	Blanco	S20.125.10	11,68€

[DESCARGAR](#)  
Ficha técnica



		Ref	PVPR
BASE DOBLE CORRIENTE 16A	Aluminio	S20.125.11	12,48€

[DESCARGAR](#)  
Ficha técnica

















**BASE 2 EN 1**  
Base doble para  
1módulo













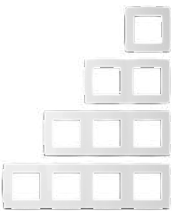

\* Según la nueva normativa ERP ha habido un cambio en la medición de Lúmenes y vatios, pero sigue emitiendo la misma cantidad de luz. A medida que vayan entrando los nuevos modelos con ERP se irá actualizando en catálogo y cajas de color. Puede haber variación respecto la caja del producto (comprobar en ficha técnica), todos los datos en catálogo están correctos salvo error tipográfico.

# Dynamic S20

Nueva serie de mecanismos **Dynamic S20** fabricados en policarbonato ignífugo, con sistema de conexión rápida y fijación por módulos. Varios colores disponibles y posibilidad de combinar teclas y marcos.

DESCRIPCIÓN	MECANISMO / TECLA-TAPA	.10	.11	TECLA-TAPA ANTRACITA S30	.12
					
 <ul style="list-style-type: none"> <li>· Interruptor</li> <li>· Conmutador</li> <li>· Interruptor bipolar</li> <li>· Pulsador</li> <li>· Cruzamiento</li> </ul>	S20.101.XX	3,92€	4,92€	S30.601.12	1,48€
	S20.102.XX	5,68€	6,68€	S30.601.12	1,48€
	S20.111.XX	6,60€	7,72€	S30.611.12	1,64€
	S20.109.XX	4,24€	5,20€	S30.609.12	1,48€
	S20.107.XX	8,56€	9,80€	S30.607.12	1,56€
 <ul style="list-style-type: none"> <li>· Pulsador con simbolo luz</li> <li>· Pulsador con simbolo timbre</li> </ul>	S20.126.XX	5,12€	5,88€	S30.628.12	1,64€
	S20.127.XX	4,24€	5,32€	S30.629.12	1,64€
 <ul style="list-style-type: none"> <li>· Interruptor doble</li> <li>· Conmutador doble</li> <li>· Conmutador+Cruzamiento</li> </ul>	S20.104.XX	5,80€	7,32€	S30.604.12	2,08€
	S20.105.XX	9,36€	10,88€	S30.604.12	2,08€
	S20.136.10	12,88€			
 <ul style="list-style-type: none"> <li>· Interruptor de persianas</li> <li>· Pulsador doble para persiana</li> </ul>	S20.120.XX	8,28€	9,56€	S30.620.12	1,64€
	S20.134.10	7,52€		S30.620.12	1,64€
 <ul style="list-style-type: none"> <li>· Interruptor luminoso LED</li> <li>· Conmutador luminoso LED</li> <li>· Pulsador luminoso LED</li> <li>· Pulsador luminoso timbre LED</li> <li>· Cruzamiento luminoso</li> <li>· Pulsador luminoso con simbolo luz</li> </ul>	S20.103.XX	6,40€	7,48€	S30.603.12	1,60€
	S20.122.XX	8,04€	9,44€	S30.603.12	1,60€
	S20.110.XX	6,76€	8,28€	S30.610.12	1,60€
	S20.108.XX	6,76€	8,28€	S30.608.12	1,60€
	S20.124.XX	11,16€	12,32€	S30.627.12	1,72€
	S20.128.XX	6,76€	7,84€	S30.630.12	1,72€
 <ul style="list-style-type: none"> <li>· Interruptor doble luminoso LED</li> <li>· Conmutador doble luminoso LED</li> </ul>	S20.106.XX	10,80€	12,48€	S30.606.12	2,12€
	S20.123.XX	14,28€	16,16€	S30.606.12	2,12€
 <ul style="list-style-type: none"> <li>· Regulador giratorio 1-10V Máx. 300W LED</li> </ul>	S20.117.XX	57,20€	59,96€	S30.617.12	2,64€
 <ul style="list-style-type: none"> <li>· Base corriente Schuko 16A Con protección infantil Conexión por tornillos</li> <li>· Base corriente Schuko 16A 2 puertos USB</li> <li>· Base corriente Schuko 16A 2 puertos USB Tipo A y C</li> </ul>	S20.112.XX	5,88€	6,80€	S30.612.12	2,00€
	S20.114.XX	48,16€	49,24€	S30.614.12	2,24€
	S20.129.10	62,48€			
 <ul style="list-style-type: none"> <li>· Base doble USB 2.1A</li> </ul>	S20.113.XX	45,44€	47,36€	S30.613.12	1,56€
 <ul style="list-style-type: none"> <li>· Base teléfono RJ11 (CAT3)</li> <li>· Base red RJ45 (CAT6)</li> <li>· Tapa base doble RJ45 Blanco</li> </ul>	S20.115.XX	7,28€	8,28€	S30.615.12	1,60€
	S20.116.XX	12,92€	14,80€	S30.616.12	1,60€
	S20.130.10	8,32€			
 <ul style="list-style-type: none"> <li>· Tapa Universal TV - FM - SAT</li> <li>· Base doble fibra óptica</li> <li>· Interruptor de tarjeta</li> </ul>	S20.121.XX	2,12€	2,52€	S30.621.12	3,00€
	S20.133.10	11€			
	S20.135.10	63,16€			
 <ul style="list-style-type: none"> <li>· Tapa salida de cable sin marco</li> <li>· Salida cables 16A con mecanismo</li> <li>· Tapa ciega</li> <li>· Timbre zumbador</li> </ul>	S20.119.XX	2,88€	4,56€		
	S20.131.XX	2,88€	4,56€		
	S20.118.XX	1,92€	2,84€		
	S20.132.XX	21,84€	25€	S30.632.12	1,88€

## Marcos disponibles en:

									
		Blanco.10	Aluminio.11	Antracita.12	Perla brus.20	Aluminio brus.21			
	· Marco 1 elemento	S20.301.XX	1,16€	2,40€	2,60€	3,04€	3,04€	 20UDS	 200UDS
	· Marco 2 elementos	S20.302.XX	1,68€	3,48€	4,12€	4,36€	4,36€	 10UDS	 100UDS
	· Marco 3 elementos	S20.303.XX	2,60€	5,60€	6,08€	6,32€	6,32€	 15UDS	 150UDS
	· Marco 4 elementos	S20.304.XX	4,28€	9,96€	10,44€	10,12€	10,12€	 10UDS	 100UDS

Transporte no incluido. Para más información y descarga de fichas técnicas - [www.atmoss.es](http://www.atmoss.es) -

TODOS LOS PRECIOS SON EN PVPR Y ESTÁN SUJETOS A MODIFICACIONES. LOS PRECIOS ESTÁN CORRECTOS SALVO ERROR TIPOGRÁFICO, EN ÚLTIMA INSTANCIA COMPROBAR EN TARIFA DE PRECIOS - COMPROBAR MEDIDAS CON EL ARTICULO EN FÍSICO YA QUE PUEDE HABER ERROR TIPOGRÁFICO

**Precio PVPR****Combinación:** Mecanismo con tecla/tapa + Marco (1elemento)

Precio en color:

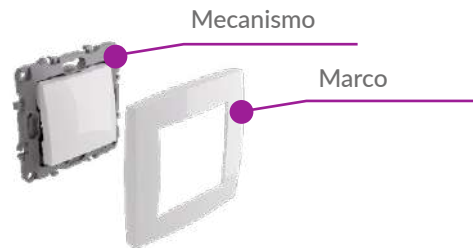
**BLANCO .10 / ALUMINIO .11 / ANTRACITA .12**

PRODUCTO COMPLETO	.10 BLANCO	.11 ALUMINIO	.12 ANTRACITA
Interruptor Unipolar	5,08€	7,32€	8€
Conmutador	6,84€	9,08€	9,76€
Interruptor bipolar	7,76€	10,12€	10,84€
Pulsador	5,40€	7,60€	8,32€
Cruzamiento	9,72€	12,20€	12,72€
Pulsador con símbolo luz	6,28€	8,28€	9,36€
Pulsador con símbolo timbre	5,40€	7,72€	8,48€
Interruptor doble	6,96€	9,72€	10,48€
Conmutador + cruzamiento	10,52€	13,28€	14,04€
Interruptor de persianas	9,44€	11,96€	12,52€
Pulsador doble para persiana	8,68€		11,76€
Interruptor luminoso led	7,56€	9,88€	10,60€
Conmutador luminoso led	9,20€	11,84€	12,24€
Pulsador luminoso led	7,92€	10,24€	10,96€
Pulsador luminoso timbre led	7,92€	10,68€	10,96€
Cruzamiento luminoso	12,32€	14,72€	15,48€
Pulsador luminoso con símbolo luz	7,92€	10,24€	11,08€
Interruptor doble luminoso led	11,96€	14,88€	15,52€
Conmutador doble luminoso led	15,44€	18,56€	19€
Regulador giratorio 1-10v	58,36€	62,36€	62,44€
Base corriente schuko 16A	7,04€	9,20€	10,48€
Base corriente schuko 16A 2 puertos USB	49,32€	51,64€	53€
Base corriente schuko 16A 2 puertos USB Tipo A y C	63,64€		
Base doble USB 2.1A	46,60€	49,76€	49,60€
Base teléfono RJ11 CAT3	8,44€	10,68€	11,48€
Base red RJ45 CAT6	14,08€	17,20€	12,12€
Tapa universal TV-FM-SAT	3,28€	4,92€	7,72€
Base doble fibra óptica	12,16€		
Interruptor de tarjeta	64,32€		
Tapa ciega	3,08€	5,24€	
Salida cables 16A	4,04€	6,96€	
Timbre zumbador	23€	27,40€	26,32€

\* Según la nueva normativa ERP ha habido un cambio en la medición de Lúmenes y vatios, pero sigue emitiendo la misma cantidad de luz.

A medida que vayan entrando los nuevos modelos con ERP se irá actualizando en catálogo y cajas de color.

Puede haber variación respecto a la caja del producto (comprobar en ficha técnica), todos los datos en catálogo están correctos salvo error tipográfico.



# Dynamic PLUS S30

MECANISMOS

10 UDS

100 UDS



DESCARGAR FICHAS TÉCNICAS



**Tecla** (Aluminio.11)  
**Cerquillo** (Aluminio.11)  
**Marco** (Blanco.10)



**Tecla.** (Antracita.12)  
**Cerquillo.** (Antracita.12)  
**Marco** (Blanco.10)



**Tecla.** (Aluminio.11)  
**Cerquillo.** (Grafito.13)  
**Marco** (Blanco.10)



**Tecla.** (Aluminio.11)  
**Cerquillo.** (Grafito.13)  
**Marco** (Negro brushed .16)



**Tecla.** (Blanco.10)  
**Cerquillo.** (Blanco.10)  
**Marco** (Blanco.10)

- S30.501.00 Interruptor
- S30.502.00 Conmutador
- S30.509.00 Pulsador
- S30.528.00 Pulsador símbolo luz
- S30.529.00 Pulsador símbolo timbre



- S30.503.00 Interruptor luminoso
- S30.508.00 Pulsador luminoso timbre
- S30.510.00 Pulsador luminoso
- S30.522.00 Conmutador luminoso
- S30.530.00 Pulsador luminoso símbolo luz
- S30.527.00 Cruzamiento luminoso led



- S30.504.00 Interruptor doble
- S30.505.00 Conmutador doble
- S30.507.00 Cruzamiento
- S30.520.00 Interruptor de persianas
- S30.534.00 Pulsador doble para persianas



- S30.506.00 Interruptor doble luminoso
- S30.523.00 Conmutador doble luminoso

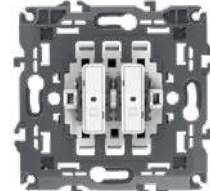

S30.511.00 - Interruptor bipolar



S30.532.00 - Timbre zumbador



S30.517.00 - Regulador giratorio 1-10V



S30.512.00 - Base corriente Schuko 16A



S30.514.00 - Base corriente 16A + 2USB

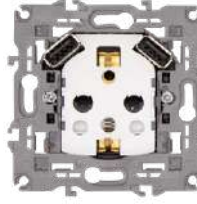

S30.513.00 - Base USB doble



PROTECCIÓN INFANTIL

8 UDS

80 UDS



PROTECCIÓN INFANTIL

6 UDS

60 UDS

6 UDS

60 UDS

S30.533.10 - Base doble fibra óptica



S30.635.10 - Interruptor de tarjeta



S30.515.00 - Base teléfono RJ11



S30.516.00 - Base Red RJ45

S30.700.10 - Marco embellecedor Blanco

30 UDS

300 UDS



S30.700.11 - Marco embellecedor Aluminio

30 UDS

300 UDS



S30.700.12 - Marco embellecedor Antracita

30 UDS

300 UDS



S30.700.13 - Marco embellecedor Grafito

30 UDS

300 UDS

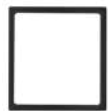

\* Según la nueva normativa ERP ha habido un cambio en la medición de Lúmenes y vatios, pero sigue emitiendo la misma cantidad de luz.

A medida que vayan entrando los nuevos modelos con ERP se irá actualizando en catálogo y cajas de color.

Puede haber variación respecto la caja del producto (comprobar en ficha técnica), todos los datos en catálogo están correctos salvo error tipográfico.

S30.601.XX - Tecla  
S30.607.XX - Tecla Cruzamiento  
S30.609.XX - Tecla pulsador

TECLAS  30 UDS  300 UDS

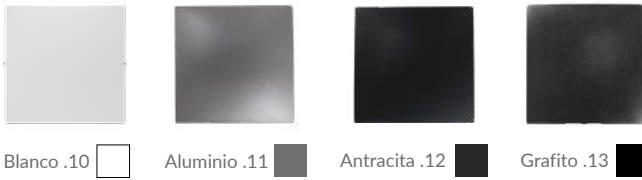

Blanco .10  Aluminio .11  Antracita .12  Grafito .13 

S30.603.10 - Tecla luminoso  
S30.610.10 - Tecla pulsador luminoso  
S30.627.10 - Tecla cruzamiento luminoso

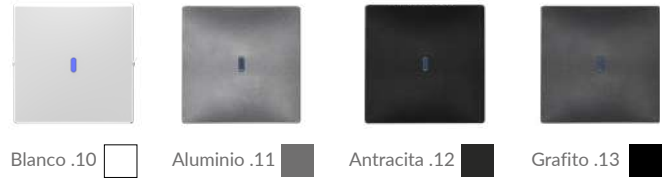

Blanco .10  Aluminio .11  Antracita .12  Grafito .13 

S30.604.XX - Tecla doble



Blanco .10  Aluminio .11  Antracita .12  Grafito .13 

S30.606.XX - Tecla doble luminoso



Blanco .10  Aluminio .11  Antracita .12  Grafito .13 

S30.629.XX - Tecla pulsador con símbolo timbre



Blanco .10  Aluminio .11  Antracita .12  Grafito .13 

S30.608.XX - Tecla timbre



Blanco .10  Aluminio .11  Antracita .12  Grafito .13 



S30.628.XX - Tecla pulsador con símbolo luz



Blanco .10  Aluminio .11  Antracita .12  Grafito .13 

S30.630.XX - Tecla pulsador luminoso con símbolo luz



Blanco .10  Aluminio .11  Antracita .12  Grafito .13 

S30.620.XX - Tecla persiana



Blanco .10  Aluminio .11  Antracita .12  Grafito .13 

S30.634.10 - Tecla pulsador doble persiana



Blanco .10 

Marco PLÁSTICO BLANCO

S30.821.10



 15 UDS  
 150 UDS

S30.822.10

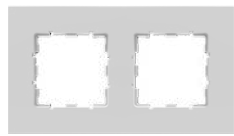

 5 UDS  
 50 UDS

S30.823.10

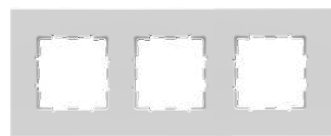

 5 UDS  
 50 UDS

S30.824.10

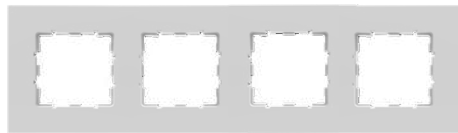

 5 UDS  
 50 UDS

Marco CRISTAL BLANCO

S30.801.10



 10 UDS  
 100 UDS

S30.802.10

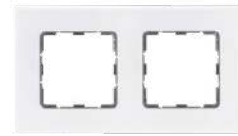

 5 UDS  
 50 UDS

S30.803.10



 5 UDS  
 50 UDS

S30.804.10



 5 UDS  
 50 UDS

S30.611.XX - Tecla interruptor bipolar

TAPAS  30 UDS  300 UDS

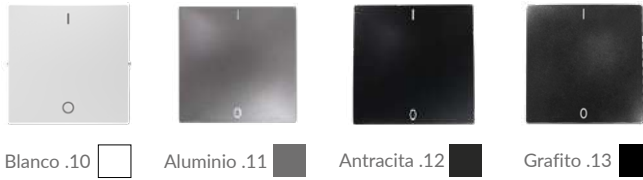

S30.615.XX - Tapa base teléfono RJ11  
S30.616.XX - Tapa base red RJ45



S30.613.XX - Tapa base USB doble



S30.617.XX - Tapa regulador giratorio 1-10V



S30.621.XX - Tapa base TV + FM + SAT





S30.632.XX - Tapa zumbador timbre



S30.612.XX - Tapa base 16A  20 UDS  200 UDS



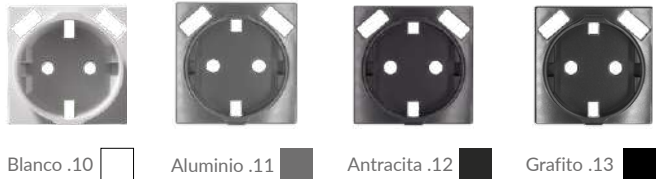

S30.614.XX - Tapa base corriente 16A + 2USB  20 UDS  200 UDS



S30.618.XX - Tapa ciega  10 UDS  100 UDS



S30.631.XX - Tapa salida cables 16A  10 UDS  100 UDS

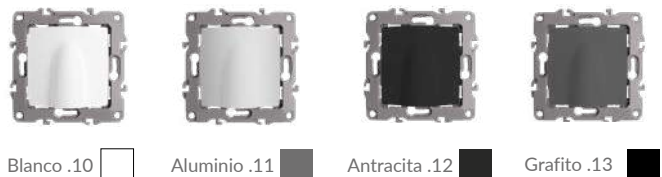

Marco **CRISTAL GRIS**

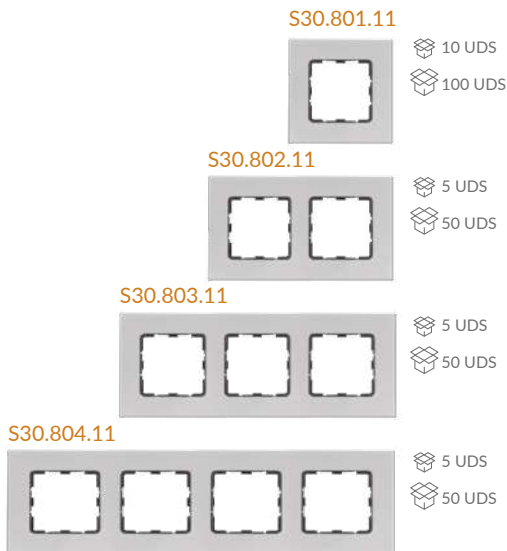

Marco **NEGRO BRUSHED**

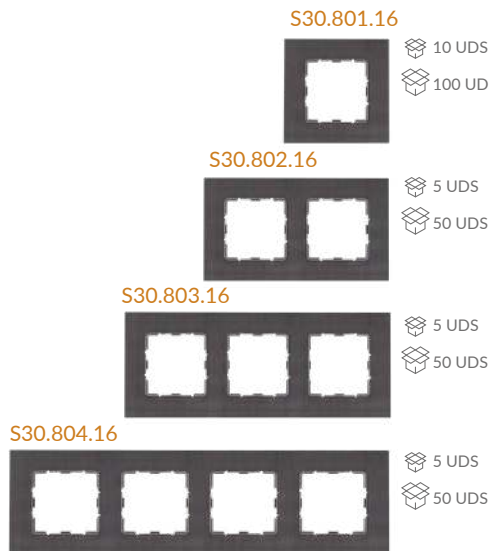



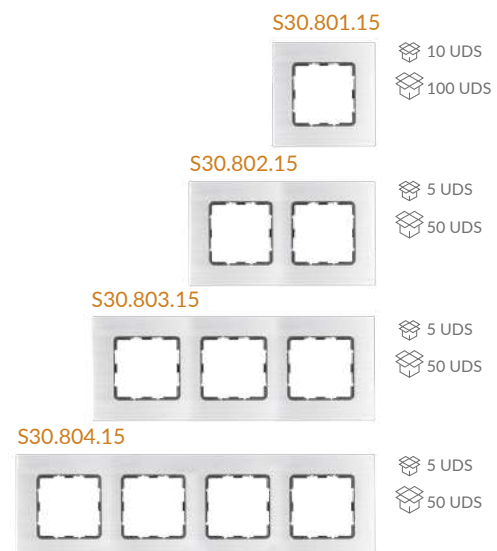











Marco **ALUMINIO BRUSHED**













\* Según la nueva normativa ERP ha habido un cambio en la medición de Lúmenes y vatios, pero sigue emitiendo la misma cantidad de luz. A medida que vayan entrando los nuevos modelos con ERP se irá actualizando en catálogo y cajas de color. Puede haber variación respecto a la caja del producto (comprobar en ficha técnica), todos los datos en catálogo están correctos salvo error tipográfico.

# Dynamic PLUS S30

Dynamic PLUS marco de cristal, plástico, aluminio. Teclas de policarbonato ignífugo, sistema de conexión rápida y fijación por módulos. Varios colores disponibles y posibilidad de combinar teclas, marcos, embellecedor.

	MECANISMO PVPR	TECLA-TAPA	.10	.11	.12	.13
	<ul style="list-style-type: none"> <li>• Interruptor S30.501.00 4,04€ / S30.601.XX 0,60€ 1,48€</li> <li>• Conmutador S30.502.00 5,40€ / S30.601.XX 0,60€ 1,48€</li> <li>• Interruptor bipolar S30.511.00 7,88€ / S30.611.XX 0,72€ 1,64€</li> <li>• Cruzamiento S30.507.00 8,80€ / S30.607.XX 0,76€ 1,56€</li> <li>• Pulsador S30.509.00 4,36€ / S30.609.XX 0,60€ 1,48€</li> <li>• Pulsador con símbolo LUZ S30.528.00 4,36€ / S30.628.XX 0,64€ 1,64€</li> <li>• Pulsador con símbolo timbre S30.529.00 4,36€ / S30.629.XX 0,64€ 1,64€</li> </ul>					
	<ul style="list-style-type: none"> <li>• Interruptor luminoso LED S30.503.00 7,24€ / S30.603.XX 0,68€ 1,60€</li> <li>• Conmutador luminoso LED S30.522.00 8,60€ / S30.603.XX 0,68€ 1,60€</li> <li>• Cruzamiento luminoso LED S30.527.00 12,08€ / S30.627.XX 0,72€ 1,72€</li> <li>• Pulsador luminoso LED S30.510.00 7,60€ / S30.610.XX 0,68€ 1,60€</li> <li>• Pulsador luminoso símbolo luz S30.530.00 7,60€ / S30.630.XX 0,72€ 1,72€</li> <li>• Pulsador luminoso timbre LED S30.508.00 7,60€ / S30.608.XX 0,68€ 1,60€</li> </ul>					
	<ul style="list-style-type: none"> <li>• Interruptor doble S30.504.00 8,64€ / S30.604.XX 0,72€ 2,08€</li> <li>• Conmutador doble S30.505.00 8,48€ / S30.604.XX 0,72€ 2,08€</li> </ul>					
	<ul style="list-style-type: none"> <li>• Interruptor doble lumi. LED S30.506.00 12,20€ / S30.606.XX 0,80€ 2,12€</li> <li>• Conmutador doble lumi. LED S30.523.00 14,64€ / S30.606.XX 0,80€ 2,12€</li> </ul>					
	<ul style="list-style-type: none"> <li>• Interruptor de persianas S30.520.00 7,08€ / S30.620.XX 0,72€ 1,64€ 8,72</li> <li>• Pulsador doble p/ persianas S30.534.00 7,48€ / S30.634.10 0,80€ S30.620.XX 1,64€</li> </ul>					
	• Regulador giratorio 1-10V Máx. 300W LED S30.517.00 48,68€ / S30.617.XX 1,08€ 2,64€					
	• Base corriente Schuko 16A Con protección infantil Conexión por tornillos S30.512.00 5,80€ / S30.612.XX 1,20€ 2,00€					
	• Base corriente Schuko 16A Con protección infantil Conexión por tornillos 2 puertos USB S30.514.00 46,16€ / S30.614.XX 1,08€ 2,24€					
	• Base doble USB 2.1A S30.513.00 46,52€ / S30.613.XX 0,68€ 1,56€					
	<ul style="list-style-type: none"> <li>• Base teléfono RJ11 (CAT3) S30.515.00 7,48€ / S30.615.XX 0,68€ 1,60€</li> <li>• Base red RJ45 (CAT6) S30.516.00 9,36€ / S30.616.XX 0,68€ 1,60€</li> </ul>					
	• Tapa Universal TV - FM - SAT Tapa - S30.621.XX 2,12€ 3,00€					
	• Timbre Zumbador S30.532.00 21,84€ / S30.632.XX 0,80€ 1,88€					
	<ul style="list-style-type: none"> <li>• Base doble fibra óptica/Blanco S30.533.10 10,92€</li> <li>- Mecanismo con tapa.</li> <li>- Añadir marco y embellecedor</li> </ul>		<ul style="list-style-type: none"> <li>• Interruptor de Tarjeta/Blanco S30.635.10 63,16€</li> <li>- Mecanismo con tapa.</li> <li>- Añadir marco y embellecedor</li> </ul>			
	<ul style="list-style-type: none"> <li>• Tapa salida cables Tapa - S30.631.XX 2,88€ 4,56€</li> <li>• Tapa ciega Tapa - S30.618.XX 1,96€ 2,84€</li> </ul>					

		Blanco.10	Gris.11	Aluminio.11	Antracita.12	Grafito.13
	• Marco embellecedor S30.700.XX 1,08€ 1,96€ 1,96€ 1,96€					
	• Marco cristal 1 elemento S30.801.XX 14,32€ 14,32€					
	• 2 elementos S30.802.XX 32,20€ 32,20€					
	• 3 elementos S30.803.XX 47,20€ 47,20€					
	• 4 elementos S30.804.XX 72,00€ 72,00€					
	• Marco plástico 1 elemento S30.821.10 1,68€					
	• 2 elementos S30.822.10 2,92€					
	• 3 elementos S30.823.10 3,68€					
	• 4 elementos S30.824.10 4,80€					
			Aluminio brushed.15	Negro brushed.16		
	• Marco aluminio brushed 1 elemento S30.801.XX 18,52€ 18,52€					
	• 2 elementos S30.802.XX 36,32€ 36,32€					
	• 3 elementos S30.803.XX 51,08€ 51,08€					
	• 4 elementos S30.804.XX 66,24€ 66,24€					

Transporte no incluido. Para más información y descarga de fichas técnicas - www.atmoss.es -

TODOS LOS PRECIOS SON EN PVPR Y ESTÁN SUJETOS A MODIFICACIONES. LOS PRECIOS ESTÁN CORRECTOS SALVO ERROR TIPOGRÁFICO, EN ÚLTIMA INSTANCIA COMPROBAR EN TARIFA DE PRECIOS - COMPROBAR MEDIDAS CON EL ARTICULO EN FÍSICO YA QUE PUEDE HABER ERROR TIPOGRÁFICO

## Precio PVPR

**Combinación:** Mecanismo + tecla + Cerquillo + Marco

Precio en color:

- BLANCO.10
- ALUMINIO.11 (+ MARCO VIDRIO GRIS.11)
- ANTRACITA.12 (+ MARCO NEGRO BRUSHED.16)

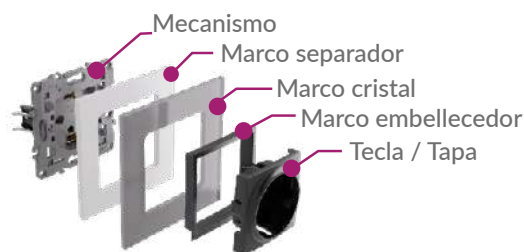

PRODUCTO COMPLETO	.10 BLANCO	.11 ALUMINIO	.12 ANTRACITA
Interruptor Unipolar	7,40€	21,80€	26€
Conmutador	8,76€	23,16€	27,36€
Interruptor bipolar	11,36€	25,80€	30€
Cruzamiento	12,32€	26,64€	30,84€
Pulsador	7,72€	22,12€	56,32€
Pulsador con símbolo luz	7,76€	22,28€	26,48€
Pulsador con símbolo timbre	6,08€	22,28€	26,48€
Interruptor luminoso LED	10,68€	25,12€	29,32€
Conmutador luminoso LED	12,04€	26,48€	30,68€
Cruzamiento luminoso LED	15,56€	30,08€	34,28€
Pulsador luminoso LED	11,04€	25,48€	29,68€
Pulsador luminoso símbolo luz	11,08€	25,60€	29,80€
Pulsador luminoso timbre LED	11,04€	25,48€	29,68€
Interruptor doble	12,12€	27€	31,20€
Conmutador doble	11,96€	26,84€	31,04€
Interruptor doble luminoso LED	15,76€	30,60€	34,80€
Conmutador doble luminoso LED	18,20€	33,04€	37,24€
Interruptor de persianas	10,56€	25€	29,20€
Pulsador doble para persianas	11,04€	25,40€	29,60€
Regulador giratorio 1-10V	52,52€	67,60€	71,80€
Base corriente Schuko 16A	9,76€	24,08€	28,28€
Base corriente Schuko 16A + 2 puertos usb	50€	64,68€	68,88€
Base doble USB 2.1A	49,96€	64,36€	68,56€
Base teléfono RJ11	10,92€	25,36€	29,56€
Base red RJ45	12,80€	27,24	31,44€
Tapa universal TV+FM+SAT	4,88€	19,28€	23,48€
Timbre zumbador	25,40€	40€	44,20€
Base doble fibra óptica/blanco	13,68€		
Interruptor tarjeta/blanco	65,92€		
Tapa salida cables	5,64€	20,84€	25,04€
Tapa ciega	4,72€	19,12€	23,32€

\* Según la nueva normativa ERP ha habido un cambio en la medición de Lúmenes y vatios, pero sigue emitiendo la misma cantidad de luz.

A medida que vayan entrando los nuevos modelos con ERP se irá actualizando en catálogo y cajas de color.

Puede haber variación respecto a la caja del producto (comprobar en ficha técnica), todos los datos en catálogo están correctos salvo error tipográfico.

# Dynamic **ART S40**

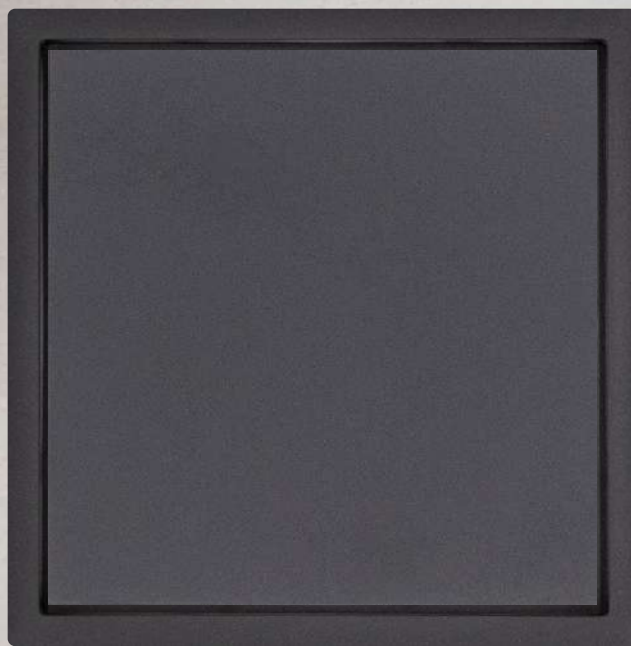
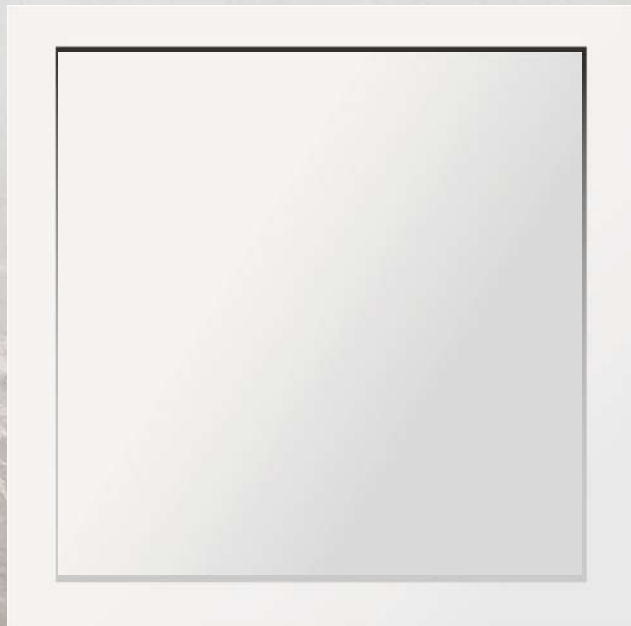



Cambio suave y silencioso.

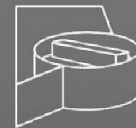

La fijación de múltiples puntos del marco de acero con piezas de montaje hace que todo el cuerpo sea más sólido y fiable.

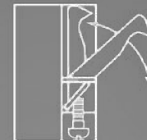

Las garras están situadas en agujeros especialmente designados. Esto hace que la instalación sea más conveniente.

Ag



Las partes de los contactos móviles están cubiertas de plata con un grosor no inferior a 0,4 mm



El plano de contacto de la conexión del cableado se realiza como "puente de arco" para una fijación más fiable del cable.



La cubierta de los contactos es de material ignífugo.

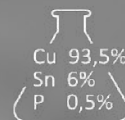

Piezas conductoras: el bronce fosforado de alta calidad proporciona un alto grado de conductividad y durabilidad.



El grosor de las piezas conductoras de más de 0,8 mm evita su calentamiento y tensión.

# Dynamic ART S40

DESCARGAR FICHAS TÉCNICAS

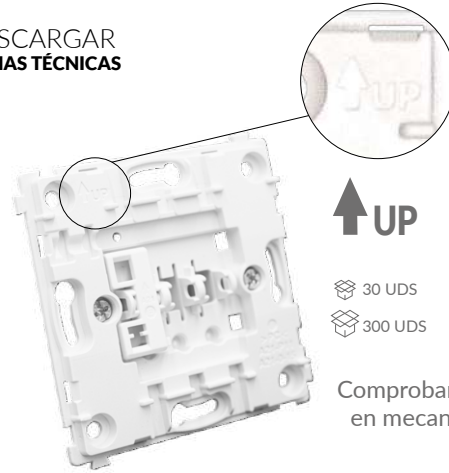

↑ UP

30 UDS  
300 UDS

Comprobar flecha de posición en mecanismo y tapa/tecla.

**TODOS LOS MECANISMOS NECESITAN MARCO Y TAPA/TECLA**

MECANISMOS  
10 UDS  
100 UDS

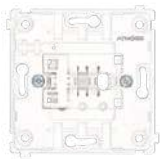

S40.501.00 INTERRUPTOR MECANISMO



S40.502.00 CONMUTADOR MECANISMO



S40.504.00 INTERRUPTOR DOBLE MECANISMO



S40.505.00 CONMUTADOR DOBLE MECANISMO

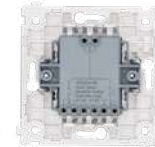

S40.520.00 PULSADOR PERSIANA MECANISMO



S40.507.00 CRUZAMIENTO MECANISMO



S40.512.00 BASE CORRIENTE 16A MECANISMO

8 UDS  
80 UDS



S40.508.00 PULSADOR TIMBRE MECANISMO



S40.513.00 BASE CORRIENTE 16A CON USB TIPO A Y C MECANISMO

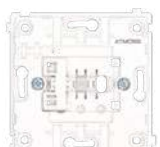

S40.509.00 PULSADOR PARA ESCALERA CON LED MECANISMO



S40.516.10 BASE RED DOBLE RJ45 CAT.6 BLANCO MECANISMO

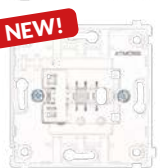

S40.515.10 BASE TELF + RED RJ11 + RJ45 BLANCO MECANISMO



S40.516.11 BASE RED DOBLE RJ45 CAT.6 ALUMINIO MECANISMO



S40.515.11 BASE TELF + RED RJ11 + RJ45 ALUMINIO MECANISMO



S40.516.17 BASE RED DOBLE RJ45 CAT.6 NEGRO MECANISMO

NEW!

S40.517.17 BASE RED DOBLE RJ45 CAT.6 NEGRO SIN CONECTOR MECANISMO



S40.515.17 BASE TELF + RED RJ11 + RJ45 NEGRO MECANISMO



S40.518.17 BASE RED UNO RJ45 CAT.6 NEGRO SIN CONECTOR MECANISMO



S40.533.00 BASE DOBLE FIBRA ÓPTICA MECANISMO

SERIE BLANCO Brillo y Mate

30 UDS 300 UDS



S40.401.10  
TECLA  
BLANCO **BRILLO**

S40.401.18  
TECLA  
BLANCO **MATE**

30 UDS 300 UDS



S40.402.10  
TECLA DOBLE  
BLANCO **BRILLO**

S40.402.18  
TECLA DOBLE  
BLANCO **MATE**

30 UDS 300 UDS



S40.403.10  
TECLA SÍMBOLO  
TIMBRE  
BLANCO **BRILLO**

S40.403.18  
TECLA SÍMBOLO  
TIMBRE  
BLANCO **MATE**

30 UDS 300 UDS



S40.404.10  
TECLA DOBLE  
CORTINA  
BLANCO **BRILLO**

S40.404.18  
TECLA DOBLE  
CORTINA  
BLANCO **MATE**

8 UDS 80 UDS



S40.618.10  
TAPA CIEGA  
BLANCO **BRILLO**

S40.618.18  
TAPA CIEGA  
BLANCO **MATE**

NEW!



S40.409.10  
TECLA PULSADOR  
ESCALERA CON LED  
BLANCO **BRILLO**

S40.409.18  
TECLA PULSADOR  
ESCALERA CON LED  
BLANCO **MATE**

30 UDS 300 UDS



S40.405.10  
TAPA BASE  
CORRIENTE 16A  
BLANCO **BRILLO**

S40.405.18  
TAPA BASE  
CORRIENTE 16A  
BLANCO **MATE**

NEW!



S40.408.10  
TAPA BASE  
CORRIENTE 16A  
CON USB A y C  
BLANCO **BRILLO**

S40.408.18  
TAPA BASE  
CORRIENTE 16A  
CON USB A y C  
BLANCO **MATE**

30 UDS 300 UDS



S40.406.10 TAPA PARA  
· BASE TELEF + RED. **RJ11 + RJ45**  
· BASE RED DOBLE **RJ45**  
· BASE DOBLE **FIBRA ÓPTICA**  
BLANCO **BRILLO**

S40.406.18 TAPA PARA  
· BASE TELEF + RED. **RJ11 + RJ45**  
· BASE RED DOBLE **RJ45**  
· BASE DOBLE **FIBRA ÓPTICA**  
BLANCO **MATE**

30 UDS 300 UDS



S40.410.10 TAPA PARA  
· TAPA BASE UNO  
RJ11 - RJ45  
BLANCO **BRILLO**

S40.410.18 TAPA PARA  
· TAPA BASE UNO  
RJ11 - RJ45  
BLANCO **MATE**

NEW!

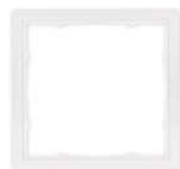

30 UDS  
300 UDS

S40.201.10  
MARCO 1 ELEMENTO  
BLANCO **BRILLO**

S40.201.18  
MARCO 1 ELEMENTO  
BLANCO **MATE**

8 UDS 80 UDS



S40.407.10  
TAPA BASE  
TV+FM+SAT  
BLANCO **BRILLO**

S40.407.18  
TAPA BASE  
TV+FM+SAT  
BLANCO **MATE**

8 UDS 80 UDS



S40.419.10  
TAPA SALIDA CABLE  
BLANCO **BRILLO**

S40.419.18  
TAPA SALIDA CABLE  
BLANCO **MATE**

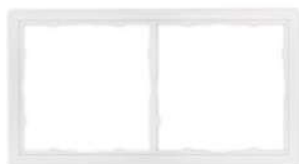

15 UDS  
150 UDS

S40.202.10  
MARCO 2 ELEMENTO  
BLANCO **BRILLO**

S40.202.18  
MARCO 2 ELEMENTO  
BLANCO **MATE**

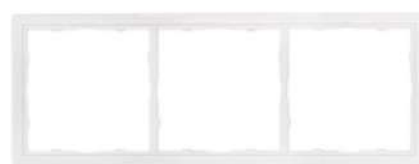

8 UDS  
80 UDS

S40.203.10  
MARCO 3 ELEMENTO  
BLANCO **BRILLO**

S40.203.18  
MARCO 3 ELEMENTO  
BLANCO **MATE**

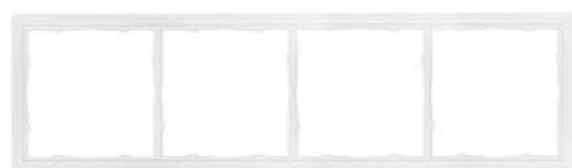

8 UDS  
80 UDS

S40.204.10  
MARCO 4 ELEMENTO  
BLANCO **BRILLO**

S40.204.18  
MARCO 4 ELEMENTO  
BLANCO **MATE**

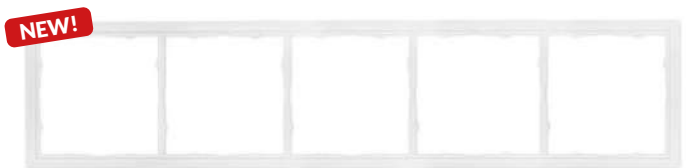

NEW!

S40.205.10  
MARCO 5 ELEMENTO  
BLANCO **BRILLO**

SERIE NEGRO MATE

30 UDS 300 UDS



S40.401.17

TECLA

NEGRO MATE

30 UDS 300 UDS



S40.402.17

TECLA DOBLE

NEGRO MATE

30 UDS 300 UDS

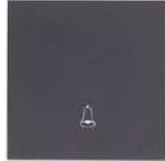

S40.403.17

TECLA SIMBOLO  
TIMBRE

NEGRO MATE

30 UDS 300 UDS



S40.404.17

TECLA DOBLE  
CORTINA

NEGRO MATE

8 UDS 80 UDS



S40.618.17

TECLA CIEGA

NEGRO MATE

NEW!



S40.409.17

TECLA PULSADOR  
ESCALERA CON LED

NEGRO MATE

30 UDS 300 UDS



S40.405.17

TAPA BASE  
CORRIENTE 16A

NEGRO MATE

NEW!



S40.408.17

TAPA BASE  
CORRIENTE 16A  
CON USB A y C

NEGRO MATE

8 UDS 80 UDS



S40.407.17

TAPA BASE  
TV+FM+SAT

NEGRO MATE

8 UDS 80 UDS



S40.419.17

TAPA SALIDA  
CABLE

NEGRO MATE

30 UDS 300 UDS

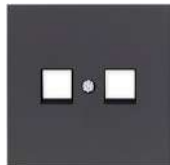

S40.406.17

TAPA PARA  
· BASE TELEF + RED. RJ11 + RJ45  
· BASE RED DOBLE RJ45  
· BASE DOBLE FIBRA ÓPTICA

NEGRO MATE

30 UDS 300 UDS



S40.410.17

TAPA PARA  
· TAPA BASE UNO RJ11 - RJ45

NEGRO MATE

S40.518.17

TAPA PARA



30 UDS  
300 UDS

S40.201.17

MARCO 1 ELEMENTO

NEGRO MATE



15 UDS  
150 UDS

S40.202.17

MARCO 2 ELEMENTO

NEGRO MATE

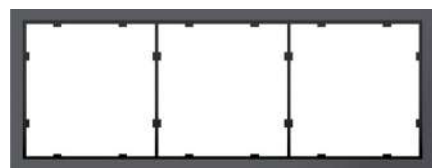

8 UDS  
80 UDS

S40.203.17

MARCO 3 ELEMENTO

NEGRO MATE



8 UDS  
80 UDS

S40.204.17

MARCO 4 ELEMENTO

NEGRO MATE

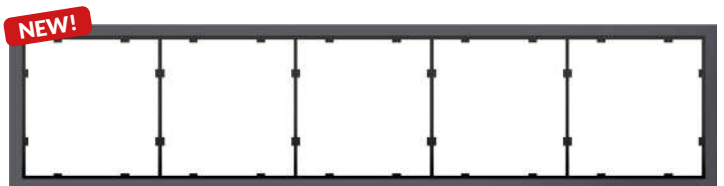

NEW!

S40.205.17

MARCO 5 ELEMENTO

NEGRO MATE

SERIE ALUMINIO MATE

30 UDS 300 UDS



**S40.401.11**  
TECLA

ALUMINIO MATE

30 UDS 300 UDS



**S40.402.11**  
TECLA DOBLE

ALUMINIO MATE

30 UDS 300 UDS



**S40.403.11**  
TECLA  
SIMBOLO TIMBRE

ALUMINIO MATE

30 UDS 300 UDS



**S40.404.11**  
TECLA DOBLE  
CORTINA

ALUMINIO MATE

8 UDS 80 UDS



**S40.618.11**  
TAPA CIEGA

ALUMINIO MATE



**S40.409.11**  
TECLA PULSADOR  
ESCALERA CON LED

ALUMINIO MATE

30 UDS 300 UDS



**S40.405.11**  
TAPA BASE  
CORRIENTE 16A

ALUMINIO MATE



**S40.408.11**  
TAPA BASE  
CORRIENTE 16A  
CON USB A y C

ALUMINIO MATE

8 UDS 80 UDS



**S40.407.11**  
TAPA BASE  
TV+FM+SAT

ALUMINIO MATE

8 UDS 80 UDS



**S40.419.11**  
TAPA SALIDA  
CABLE

ALUMINIO MATE

30 UDS 300 UDS



**S40.406.11** TAPA PARA  
· BASE TELEF + RED. **RJ11 + RJ45**  
· BASE RED DOBLE **RJ45**  
· BASE DOBLE **FIBRA ÓPTICA**

ALUMINIO MATE

30 UDS 300 UDS



**S40.410.11** TAPA PARA  
· TAPA BASE UNO **S40.518.17**  
RJ11 - RJ45

ALUMINIO MATE



30 UDS  
300 UDS

**S40.201.11**  
MARCO 1 ELEMENTO

ALUMINIO MATE



15 UDS  
150 UDS

**S40.202.11**  
MARCO 2 ELEMENTO

ALUMINIO MATE

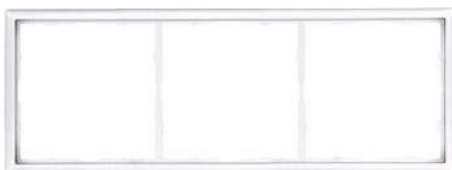

8 UDS  
80 UDS

**S40.203.11**  
MARCO 3 ELEMENTO

ALUMINIO MATE

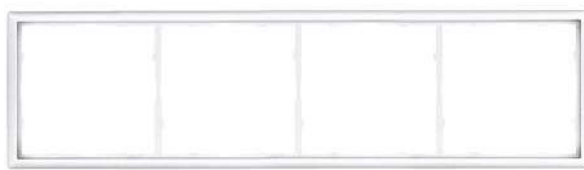

8 UDS  
80 UDS

**S40.204.11**  
MARCO 4 ELEMENTO

ALUMINIO MATE

\* Según la nueva normativa ERP ha habido un cambio en la medición de Lúmenes y vatios, pero sigue emitiendo la misma cantidad de luz. A medida que vayan entrando los nuevos modelos con ERP se irá actualizando en catálogo y cajas de color. Puede haber variación respecto la caja del producto (comprobar en ficha técnica), todos los datos en catálogo están correctos salvo error tipográfico.

# Dynamic ART S40

Estilo renovado con su forma cuadrada y un marco fino. Se integran discretamente en cualquier ambiente. Una selección de materiales de alta calidad que ofrece todas las opciones para hacer que las ideas personales de decoración se hagan realidad.

MECANISMO PVPR / TECLA-TAPA

.10    .18 Mate    .11 .17



· Interruptor	S40.501.00	6,40€ /	S40.401.XX	1,48€	2,20€	2,56€
· Conmutador	S40.502.00	7,08€ /	S40.401.XX	1,48€	2,20€	2,56€
· Cruzamiento	S40.507.00	10,60€ /	S40.401.XX	1,48€	2,20€	2,56€



· Interruptor doble	S40.504.00	8,04€ /	S40.402.XX	2,20€	2,84€	3,08€
· Conmutador doble	S40.505.00	9,68€ /	S40.402.XX	2,20€	2,84€	3,08€



· Pulsador timbre	S40.508.00	7,08€ /	S40.403.XX	1,88€	2,36€	2,88€
-------------------	------------	---------	------------	-------	-------	-------



· Pulsador persiana	S40.520.00	8,96€ /	S40.404.XX	2,36€	3,00€	3,60€
· Tecla pulsador escalera con led	S40.509.00	10,16€ /	S40.409.XX	1,84€	2,56€	2,84€



· Base corriente 16A	S40.512.00	6,04€ /	S40.405.XX	3,00€	3,72€	4,40€
----------------------	------------	---------	------------	-------	-------	-------



· Base corriente 16A USB Tipo A,C	S40.513.00	54,0€ /	S40.408.XX	2,92€	4,08€	4,28€
-----------------------------------	------------	---------	------------	-------	-------	-------



La base de teléfono y base de red doble tiene un color a elegir .10 / .11 / .17

MECANISMO



TAPA

· Base teléfono + Red (RJ11 + RJ45)	S40.515.XX	24,32€	26,08€	26,08€	/	S40.406.XX	1,72€	2,72€	3,28€
-------------------------------------	------------	--------	--------	--------	---	------------	-------	-------	-------



· Base Red doble RJ45 (CAT.6)	S40.516.XX	14,16€	15,76€	15,76€	/	S40.406.XX	1,72€	2,72€	3,28€
-------------------------------	------------	--------	--------	--------	---	------------	-------	-------	-------



· Base Red doble RJ45 SIN CONECTOR	S40.517.17	7,12€			/	S40.406.XX	1,72€	2,72€	3,28€
------------------------------------	------------	-------	--	--	---	------------	-------	-------	-------



· Base Red uno RJ45 SIN CONECTOR	S40.518.17	6,64€			/	S40.410.XX	1,60€	3€	3,40€
----------------------------------	------------	-------	--	--	---	------------	-------	----	-------



· Base doble fibra óptica	S40.533.00	17,12€				S40.406.XX	1,72€	2,72€	3,28€
---------------------------	------------	--------	--	--	--	------------	-------	-------	-------

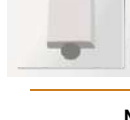

· Tapa universal TV + FM + SAT	S40.407.XX	1,56€	2,64€	3,08€
--------------------------------	------------	-------	-------	-------



· Tapa Salida cable	S40.419.XX	5,04€	5,12€	6,72€
---------------------	------------	-------	-------	-------



· Tapa Ciega	S40.618.XX	5,12€	5,92€	6,88€
--------------	------------	-------	-------	-------

	Blanco.....	10
	Blanco mate.....	18
	Aluminio.....	11
	Antracita.....	12
	Grafito.....	13
	Negro.....	17

Marcos disponibles en:

Blanco.10    Blanco mate.18    Aluminio.11    Negro.17

· Marco plástico 1 elemento	S40.201.XX	1,56€	2,08€	2,44€	2,44€
· Marco plástico 2 elementos	S40.202.XX	2,36€	4,08€	4,72€	4,72€
· Marco plástico 3 elementos	S40.203.XX	5,88€	7,80€	11,84€	11,84€
· Marco plástico 4 elementos	S40.204.XX	6,96€	9,04€	14,84€	14,84€
· Marco plástico 5 elementos	S40.205.XX	9,44€			19,92€

## Precio PVPR

**Combinación:** Mecanismo + Tecla/Tapa + Marco 1 elemento

Precio en color:

- BLANCO.10
- BLANCO MATE .18
- ALUMINIO.11
- NEGRO.17

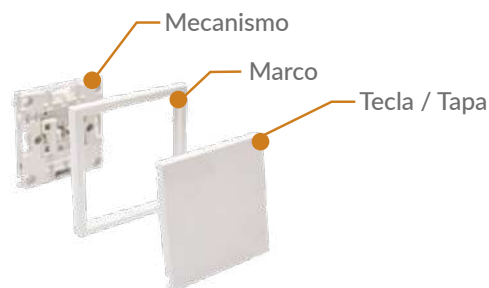

PRODUCTO COMPLETO	.10 BLANCO	.18 BLANCO MATE	.11 ALUMINIO .17 NEGRO
Interruptor Unipolar	9,44€	10,68€	11,40€
Conmutador	10,12€	11,36€	12,08€
Cruzamiento	13,64€	14,88€	15,60€
Interruptor doble	11,80€	12,96€	13,56€
Conmutador doble	13,44€	14,60€	15,20€
Pulsador timbre	10,52€	11,52€	12,40€
Pulsador persiana	12,88€	14,04€	15€
Base corriente 16A	10,60€	11,84€	12,88€
Base teléfono + red (RJ45+ RJ11)	27,60€	29,12€	31,80€
Base red doble RJ45	17,44€	18,96€	21,48€
Base doble fibra óptica	20,40€	--	22,84€
Tapa universal TV + FM + SAT	3,12€	4,20€	5,52€
Tapa salida cable	6,60€	7,20€	9,16€
Tapa ciega	6,68€	8,00€	9,32€

## Interruptor tarjeta



8800 W - TIEMPO 20s -

INTERRUPTOR DE TARJETA

Blanco

REF

PVPR

SGR-044

19,12€

INTERRUPTOR DE TARJETA

Negro

SGR-045

20,40€



CAJA DE EMPOTRAR  
INCLUIDO EN EL PRECIO

Corte  
71mm

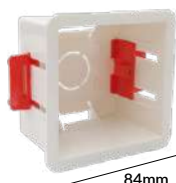

84mm

84mm

\* Según la nueva normativa ERP ha habido un cambio en la medición de Lúmenes y vatios, pero sigue emitiendo la misma cantidad de luz.

A medida que vayan entrando los nuevos modelos con ERP se irá actualizando en catálogo y cajas de color.

Puede haber variación respecto la caja del producto (comprobar en ficha técnica), todos los datos en catálogo están correctos salvo error tipográfico.

# Mecanismos S55

## EXTERIOR IP55



DESCARGAR  
FICHAS TÉCNICAS

Los **mecanismos S55** son la nueva propuesta de Atmoss de interruptores y enchufes para exterior y zonas al aire libre. Esta nueva gama cuenta con interruptores y enchufes para **superficies y empotrados** con un diseño ergonómico muy decorativo.

Lo mejor de estos mecanismos es que son capaces de resistir en el exterior a diversas condiciones medioambientales.

## Ventajas

**Diseño innovador:** el estilo de los mecanismos es robusto y con perfil curvado, todo ello combinado con un estilo moderno y contemporáneo. También tienen un avanzado diseño ergonómico que facilita su instalación.

**Empotrados y de superficie:** tanto si quieres sustituir tus actuales mecanismos, como si tienes que realizar una nueva instalación, podrás elegir entre sus dos opciones.

**Mecanismos seguros y robustos:** gracias a su clasificación **IP55** son impermeables, mientras que su clasificación **IK06** los hace resistentes contra la suciedad el polvo y productos solventes, como cementos, pegamentos o removedores de pintura y barniz. Sus componentes están reforzados con fuertes herrajes para mecanismos, cajas y marcos rígidos, así como una junta de membrana impermeable. Esa clasificación IK06 significa también que son resistentes a los rayos UV, lo que significa que la versión en blanco polar no sufre decoloración con el tiempo.



# Aplicaciones y combinaciones diferentes

- Posibilidad de empotrado o superficie.
- Protección IP55

**MÚLTIPLES  
COMBINACIONES**

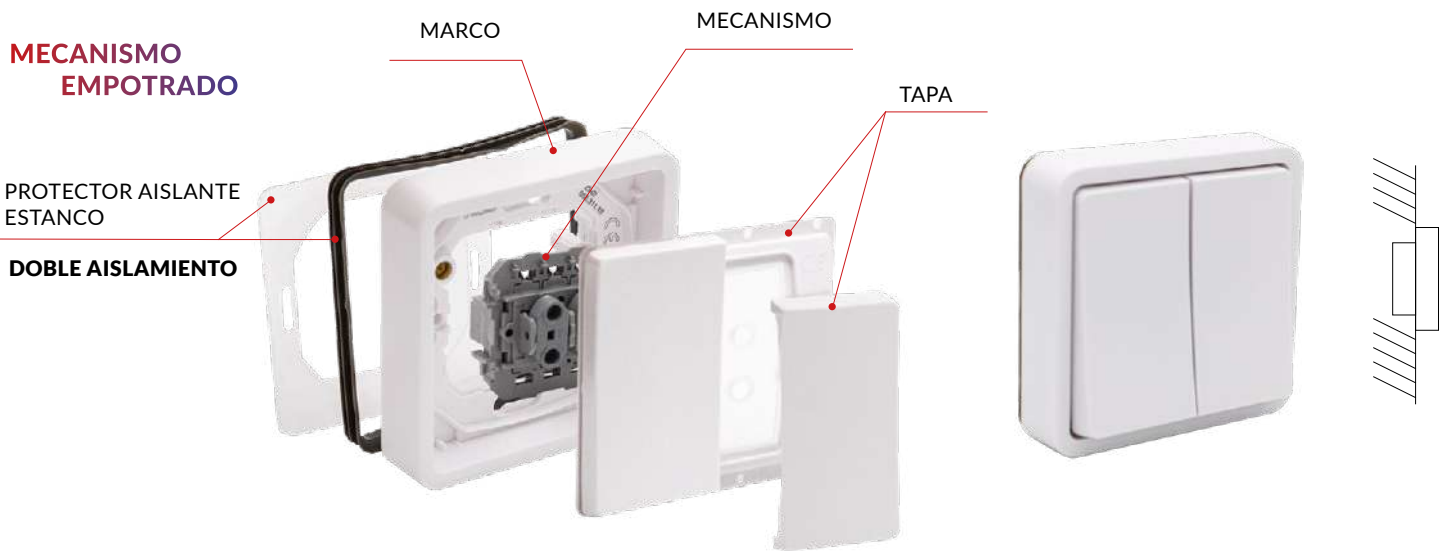

**MECANISMO SUPERFICIE**

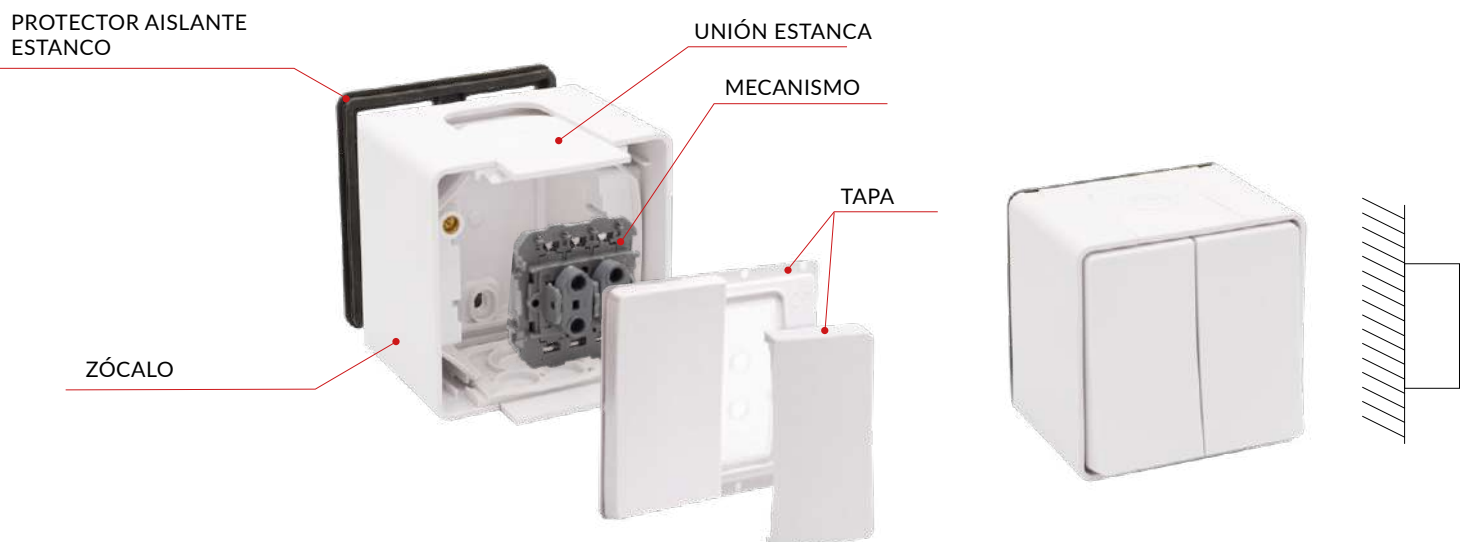



S55.112.10

BASE CORRIENTE 16A CON TAPA BLANCO S55

8 UDS

PVPR - 8,24€

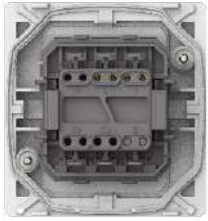

**NEW!**

S55.101.10

INTERRUPTOR BLANCO S55

10 UDS



**NEW!**

S55.103.10

INTERRUPTOR LUMINOSO BLANCO S55

10 UDS

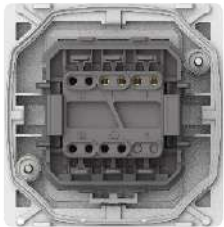

S55.110.10

PULSADOR LUMINOSO BLANCO S55

10 UDS

PVPR - 8,72€



S55.109.10

PULSADOR BLANCO S55

10 UDS

PVPR - 6,88€



S55.102.10

CONMUTADOR BLANCO S55

10 UDS

PVPR - 8,16€

\* Según la nueva normativa ERP ha habido un cambio en la medición de Lúmenes y vatios, pero sigue emitiendo la misma cantidad de luz.

A medida que vayan entrando los nuevos modelos con ERP se irá actualizando en catálogo y cajas de color.

Puede haber variación respecto la caja del producto (comprobar en ficha técnica), todos los datos en catálogo están correctos salvo error tipográfico.



**NEW!**

S55.101.10

INTERRUPTOR BLANCO S55

10 UDS



**NEW!**

S55.124.10

CRUZAMIENTO BLANCO BLANCO S55

8 UDS

PVPR - 16,96€

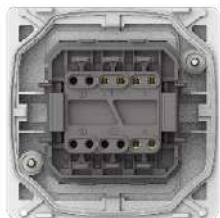

**NEW!**

S55.106.10

INTERRUPTOR DOBLE LUMINOSO  
BLANCO S55

10 UDS

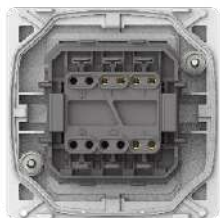

**NEW!**

S55.122.10

CONMUTADOR DOBLE LUMINOSO  
BLANCO S55

10 UDS



S55.105.10

CONMUTADOR DOBLE BLANCO S55

10 UDS

PVPR - 11,44€



**NEW!**

S55.104.10

INTERRUPTOR DOBLE BLANCO S55

10 UDS

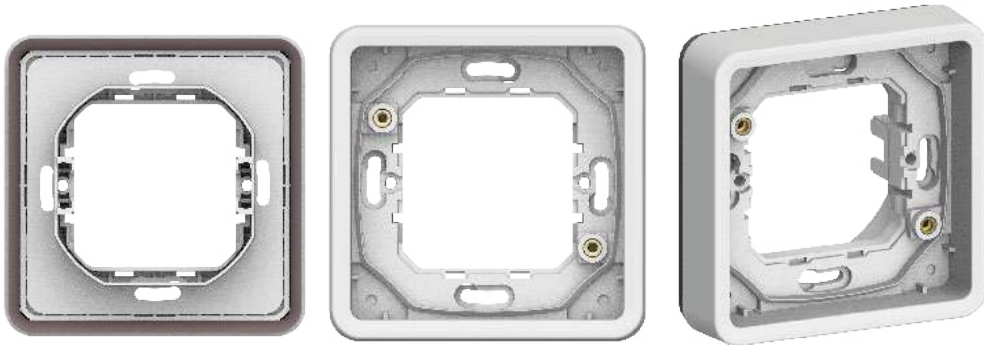

S55.311.10

MARCO 1 ELEMENTO BLANCO S55  
EMPOTRAR

12 UDS

PVPR - 5,44€



S55.312.10

MARCO 2 ELEMENTOS BLANCO S55  
EMPOTRAR

6 UDS

PVPR - 10,32€



**NEW!**

S55.313.10

MARCO 3 ELEMENTOS BLANCO S55  
EMPOTRAR

5 UDS

PVPR - 16,80€

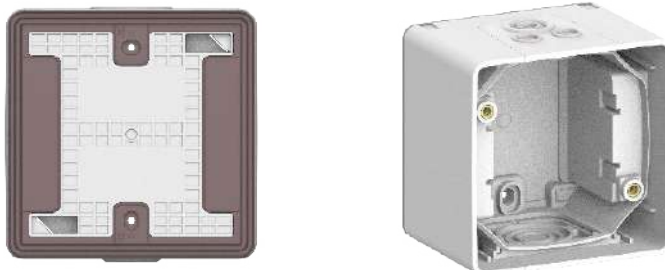

S55.910.10

CAJA SUPERFICIE 1 ELEMENTO PARA  
MECANISMOS S55

8 UDS

PVPR - 5,60€



S55.911.10

CAJA SUPERFICIE 2 ELEMENTOS PARA  
MECANISMOS S55

4 UDS

PVPR - 8,40€



**SOLO VÁLIDO PARA LOS  
MODULOS ESTRECHOS**

S55.310.10

TAPA PARA MARCO EST/EMP VARIOS  
MECANISMOS S55

14 UDS

PVPR - 3,44€



**Combina con los modulos  
estrechos a tu gusto**



**NEW!**

S55.512.10

CONMUTADOR ESTRECHO BLANCO  
MECANISMO S55

16 UDS

PVPR - 4,76€



S55.601.10

TAPA CIEGA MODULO ESTRECHO  
MECANISMO S55

30 UDS

PVPR - 1,12€



S55.516.10

BASE RED RJ45 MODULO ESTRECHO  
MECANISMO S55

16 UDS

PVPR - 13,92€



S55.535.10

BASE TV MODULO ESTRECHO  
MECANISMO S55

16 UDS

PVPR - 9,68€



S55.513.10

BASE USB+TIPO C MODULO ESTRECHO  
MECANISMO S55

12 UDS

PVPR - 45,92€

FICHA TÉCNICA

## Precios PVPR

Referencia	Descripción	PVPR	UDS
S55.112.10	BASE CORRIENTE 16A CON TAPA BLANCO S55	PVPR - <b>8,24€</b>	 8 UDS
S55.105.10	CONMUTADOR DOBLE BLANCO S20	PVPR - <b>11,44€</b>	 10 UDS
S55.102.10	CONMUTADOR BLANCO S55	PVPR - <b>8,16€</b>	 10 UDS
S55.109.10	PULSADOR EMPOTRAR BLANCO S55	PVPR - <b>6,88€</b>	 10 UDS
S55.110.10	PULSADOR LUMINOSO EMPOTRAR BLANCO S55	PVPR - <b>8,72€</b>	 10 UDS
S55.311.10	MARCO 1 ELEMENTO BLANCO S55	PVPR - <b>5,44€</b>	 12 UDS
S55.312.10	MARCO 2 ELEMENTOS BLANCO S55	PVPR - <b>10,32€</b>	 6 UDS
S55.312.10	MARCO 2 ELEMENTOS BLANCO S55	PVPR - <b>10,32€</b>	 6 UDS
S55.910.10	CAJA SUPERFICIE 1 ELEMENTO PARA MECANISMOS S55	PVPR - <b>5,60€</b>	 8 UDS
S55.911.10	CAJA SUPERFICIE 2 ELEMENTOS PARA MECANISMOS S55	PVPR - <b>8,40€</b>	 4 UDS
S55.310.10	TAPA PARA MARCO EST/EMP VARIOS MECANISMOS S55	PVPR - <b>3,44€</b>	 14 UDS
S55.516.10	BASE RED RJ45 MODULO ESTRECHO MECANISMO S55	PVPR - <b>13,92€</b>	 16 UDS
S55.535.10	BASE TV MODULO ESTRECHO MECANISMO S55	PVPR - <b>9,68€</b>	 16 UDS
S55.513.10	BASE USB+TIPO C MODULO ESTRECHO MECANISMO S55	PVPR - <b>45,92€</b>	 12 UDS
S55.601.10	TAPA CIEGA MODULO ESTRECHO MECANISMOS S55	PVPR - <b>1,12€</b>	 30 UDS

\* Según la nueva normativa ERP ha habido un cambio en la medición de Lúmenes y vatios, pero sigue emitiendo la misma cantidad de luz.  
A medida que vayan entrando los nuevos modelos con ERP se irá actualizando en catálogo y cajas de color.  
Puede haber variación respecto la caja del producto (comprobar en ficha técnica), todos los datos en catálogo están correctos salvo error tipográfico.



 IP65

The IP65 rating icon features a red square background with a white border. Inside the square, there are two white water droplets above the text "IP65" in white. The "IP" is in a larger font, and "65" is in a smaller font.

**Estanco** 



CONEXIÓN CON TORNILLOS

IP65

PARA EXTERIOR

12

120



**Descripción**

**Código**

**PVPR**

Interruptor (10A-250V~) S60.401.14 **9,36€**

Conmutador (10A-250V~) S60.402.14 **11,84€**

Pulsador piloto LED (10A-250V~) S60.403.14 **13,92€**

Conmutador doble (10A-250V~) S60.404.14 **14,24€**

Base Schuko enchufe (16A-250V~) S60.405.14 **9,96€**

Block doble base Schuko (16A-250V~) S60.406.14 **20,40€**

Block base Schuko + Int - Conmut (16A-250V~) S60.407.14 **24,76€**

Unión para mecanismo SUPERFICIE S60 S60.901.00 **13,88€**



ACLED-475



ACLED-476

## Interruptor Temporizador táctil



Hecho de material de PVC de **ALTA CALIDAD, RESISTENTE Y DURADERO, FÁCIL DE LIMPIAR**. El sensor táctil es muy sensible y **FÁCIL DE USAR**, cuando lo tocas, el indicador LED se enciende. Relé de alta potencia de 16A, este interruptor es compatible con todo tipo de lámparas incandescentes y fluorescentes. Con **16 NIVELES DE AJUSTE DE TIEMPO**, oscila entre 2 minutos y 120 minutos, más ahorro de energía. Adecuado para **USO EN EXTERIORES E INTERIORES**, ampliamente utilizado en muchos lugares, como almacenes, escaleras, etc.

• Tiempo mínimo:

**2 minutos**

• Tiempo máximo:

**2 horas**

1 UDS

		REF	PVPR
INTERRUPTOR TÁCTIL TEMPORIZADOR DE PARED	BLANCO	ACLED-475	59,70€
INTERRUPTOR TÁCTIL TEMPORIZADOR DE PARED	NEGRO	ACLED-476	59,70€



DESCARGAR  
FICHA TÉCNICA

### Descripción:



**AHORRO DE ENERGÍA:** Con 16 configuraciones de temporizador de 2 minutos a 120 minutos, puede encender y apagar las luces de su casa automáticamente, ahorrando tiempo y energía



**ILUMINACIÓN VERSÁTIL:** Relé de alto rendimiento de 16A, este interruptor de luz es compatible con todo tipo de lámparas incandescentes y fluorescentes para uso exterior o interior, versátil en muchos lugares como almacenes, escaleras, etc.



**FÁCIL INSTALACIÓN:** La instalación fácil ahorra tiempo. Apague la alimentación en el disyuntor para evitar descargas eléctricas. Simplemente retire su interruptor existente, instale el interruptor de luz y encienda el disyuntor



**SENSOR TÁCTIL LED:** El sensor táctil es muy sensible y fácil de usar. Cuando lo tocas, la luz LED se enciende para ayudarte a localizar fácilmente los interruptores de luz en la oscuridad



Uso ideal para:

Almacenes



Garajes

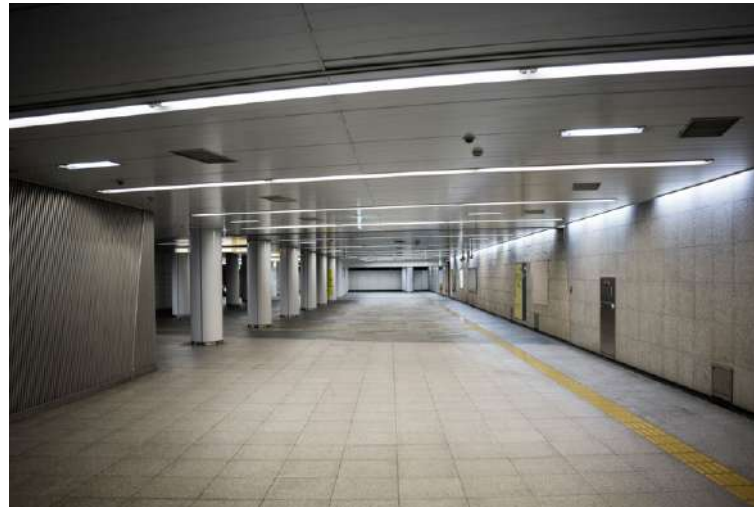

Trasteros



Escaleras



## PROGRAMACIÓN HORARIO

16 MODOS

Tenga en cuenta que la barra negra indica la posición del interruptor DIP.

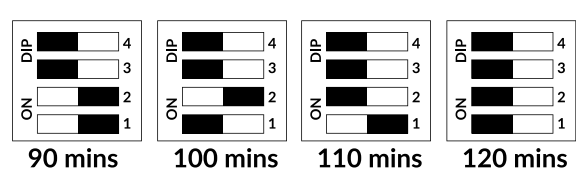
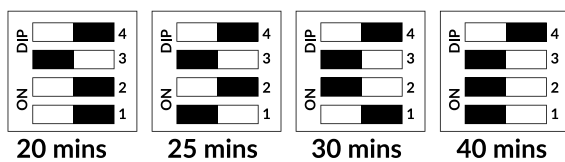
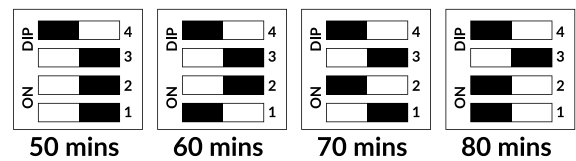
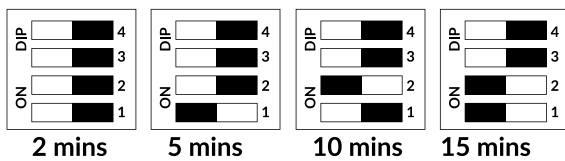

\* Según la nueva normativa ERP ha habido un cambio en la medición de Lúmenes y vatios, pero sigue emitiendo la misma cantidad de luz. A medida que vayan entrando los nuevos modelos con ERP se irá actualizando en catálogo y cajas de color. Puede haber variación respecto la caja del producto (comprobar en ficha técnica), todos los datos en catálogo están correctos salvo error tipográfico.

# ATMOSS<sup>®</sup>



Serie **PEQUEÑO MATERIAL**  
**ELÉCTRICO**

# NEW DESIGN | MODERNO Y MINIMALISTA



**Botón On/Off**  
Led indicador

### Contactos de bronce

- Alta resistencia a la corrosión.
- Alta dureza.
- Mayor durabilidad.



Embalaje en  
bolsa de pvc



**BASE USB**



Tipo A 20w - 2000mA

Tipo C - Carga rápida  
18w - 3000mA



## MultiFijación Fijación en pared - superficie



Incluye tornillos y tacos para anclaje en pared

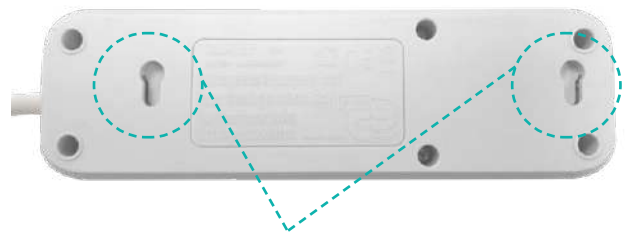
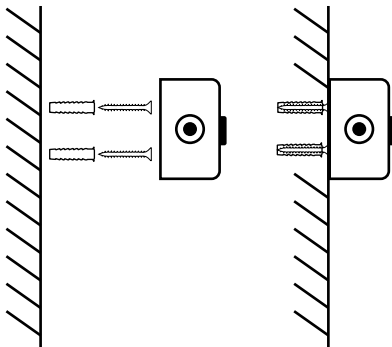

Anclaje para fijación en pared

Botón On/Off

**DISEÑO**  
MINIMALISTA



**BASE TOMAS CON CABLE + INTERRUPTOR + PROTECCIÓN INFANTIL**



40 UDS



**MTE-0001 - Base 3 tomas**

250v - 16A  
IP20  
Potencia máx: 3680w  
Cable: 3 x 1.5mm<sup>2</sup> - 1.4m

PVPR  
14,10€



**MTE-0002 - Base 4 tomas**

250v - 16A  
IP20  
Potencia máx: 3680w  
Cable: 3 x 1.5mm<sup>2</sup> - 1.4m

PVPR  
15,30€



**MTE-0005 - Base 4 tomas + USB**

250v - 16A  
IP20  
Potencia máx: 3680w  
Cable: 3 x 1.5mm<sup>2</sup> - 1.4m  
Base USB.

PVPR  
41,88€

Base A - 20w - 2000mA  
Base C - 18w - 3000mA



**MTE-0003 - Base 5 tomas**

250v - 16A  
IP20  
Potencia máx: 3680w  
Cable: 3 x 1.5mm<sup>2</sup> - 1.4m

PVPR  
16,50€



**MTE-0004 - Base 6 tomas**

250v - 16A  
IP20  
Potencia máx: 3680w  
Cable: 3 x 1.5mm<sup>2</sup> - 1.4m

PVPR  
17,85€

\* Según la nueva normativa ERP ha habido un cambio en la medición de Lúmenes y vatios, pero sigue emitiendo la misma cantidad de luz. A medida que vayan entrando los nuevos modelos con ERP se irá actualizando en catálogo y cajas de color. Puede haber variación respecto la caja del producto (comprobar en ficha técnica), todos los datos en catálogo están correctos salvo error tipográfico.

## Base de enchufe SIN CABLE

- Tapa desmontable
- Fácil conexión de cables
- Anclaje en pared

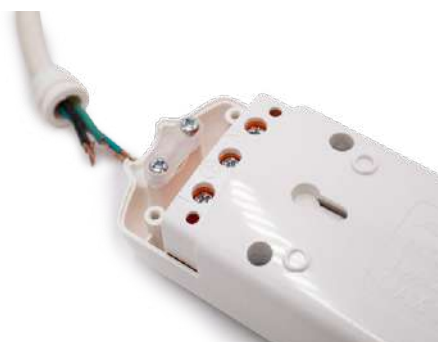

## BASE TOMAS SIN CABLE + PROTECCIÓN INFANTIL



**SIN CABLE**



1 UD

**MTE-0028 - Base 3 tomas**

PVPR  
7,47€

250v - 16A  
IP20  
Potencia máx: 3680w  
Sin Cable



**MTE-0029 - Base 4 tomas**

8,37€

250v - 16A  
IP20  
Potencia máx: 3680w  
Sin Cable

## Base de enchufe EXTERIOR IP54



 1 UD

### **MTE-0040 - Base 3 tomas**

250v - 16A  
IP54  
Potencia máx: 3680w

PVPR  
18,90€



 1 UD

### **MTE-0041 - Base 6 tomas**

250v - 16A  
IP54  
Potencia máx: 3680w

PVPR  
23,85€

### CLAVIJA SCHUKO GOMA 16A



25 UDS

**MTE-0009 - Macho Negro**

250v - 16A  
IP20

PVPR

2,43€



25 UDS

**MTE-0010 - Macho Blanco**

250v - 16A  
IP20

PVPR

2,43€



25 UDS

**MTE-0016 - Hembra Negro**

250v - 16A  
IP20

PVPR

3,78€



25 UDS

**MTE-0015 - Hembra Blanco**

250v - 16A  
IP20

PVPR

3,78€

**NEW!**

### CLAVIJA SCHUKO CON ASA 16A



10 UDS

**MTE-0034 - Macho Negro**

250v - 16A  
IP20

PVPR

2,88€



10 UDS

**MTE-0032 - Macho Blanco**

250v - 16A  
IP20

PVPR

2,88€



10 UDS

**MTE-0035 - Hembra Negro**

250v - 16A  
IP20

PVPR

3,09€



10 UDS

**MTE-0033 - Hembra Blanco**

250v - 16A  
IP20

PVPR

3,09€

### CLAVIJA 4mm 10A 250V PROTECCIÓN INFANTIL



25 UDS

**MTE-0013 - Hembra Negro**

250v - 10A  
IP20  
4mm

PVPR

2,07€



25 UDS

**MTE-0012 - Hembra Blanco**

250v - 10A  
IP20  
4mm

PVPR

2,07€



50 UDS

**MTE-0020 - Macho Negro**

250v - 10A  
IP20  
4mm

PVPR

1,65€



50 UDS

**MTE-0019 - Macho Blanco**

250v - 10A  
IP20  
4mm

PVPR

1,65€

## CLAVIJA SCHUKO PLANA 16A



25 UDS



**MTE-0026 - Clavija Schuko macho 4.8mm 16A Marfil**

250v - 16A  
IP20  
Plana

PVPR  
2,31€



**MTE-0027 - Clavija Schuko macho 4.8mm 16A Negro**

250v - 16A  
IP20  
Plana

2,31€

**NEW!**

## CLAVIJA SCHUKO AEREA 16A

FACIL  
INSTALACIÓN DE  
CONEXIÓN



10 UDS



**MTE-0037 - Macho Negro**

250v - 16A  
IP20

PVPR  
3,66€

10 UDS



**MTE-0036 - Macho Blanco**

250v - 16A  
IP20

PVPR  
3,66€

10 UDS



**MTE-0039 - Hembra Negro**

250v - 16A  
IP20

PVPR  
4,38€

10 UDS



**MTE-0038 - Hembra Blanco**

250v - 16A  
IP20

PVPR  
4,38€



 10 UDS

PVPR

**MTE-0008 - Toma para horno 25A**

7,74€

250v - 25A  
2P+E  
PP Material  
IP20



 10 UDS

PVPR

**MTE-0014 - Clavija macho para horno 25A**

7,02€

250v - 25A  
2P+E  
PP Material  
IP20

ADAPTADOR TOMAS SCHUKO 16A 250V PROTECCIÓN INFANTIL



10 UDS



**MTE-0022 - 3 TOMAS**

PVPR

250v - 16A  
IP20  
4.8mm

6,60€



**MTE-0023 - 2 TOMAS**

PVPR

250v - 16A  
IP20  
4.8mm

5,85€



**MTE-0024 - 2 TOMAS**

PVPR

250v - 16A  
IP20  
4.8mm

4,35€



**MTE-0025 - 3 TOMAS**

PVPR

250v - 16A  
IP20  
4.8mm

5,82€

Haz tu instalación  
SEGURA en el exterior

IP  
44



CLAVIJA SCHUKO GOMA 16A - IMPERMEABLE

10 UDS

PVPR

**MTE-0011 - MACHO NEGRO** 3,27€

250v - 16A  
IP44  
Cable 1.5mm<sup>2</sup>



10 UDS

PVPR

**MTE-0021 - HEMBRA NEGRO** 4,77€

250v - 16A  
IP44  
Cable 1.5mm<sup>2</sup>



**FACIL  
INSTALACIÓN  
DE CONEXIÓN**



**NEW!**

**CLAVIJA SCHUKO EXTERIOR GOMA 16A**



10 UDS

**MTE-0030 - Macho Rojo**

PVPR

250v - 16A  
IP54

4,80€



10 UDS

**MTE-0031 - Hembra Rojo**

PVPR

250v - 16A  
IP54

6,30€

**NEW!**

**BASE MULTIPLE EXTERIOR 3 TOMAS 16A**



1 UDS

**MTE-0044 - Hembra Rojo**

· Material libre de halógenos

PVPR

· Resistencia al fuego 750°C

14,85€

· Resistencia al calor 70/125°C

· Potencia máx 3680w

· Grado de protección IP44

2P + T

250v - 16A

IP44

Potencia máx 3680w

Material PP

\* Según la nueva normativa ERP ha habido un cambio en la medición de Lúmenes y vatios, pero sigue emitiendo la misma cantidad de luz.

A medida que vayan entrando los nuevos modelos con ERP se irá actualizando en catálogo y cajas de color.

Puede haber variación respecto la caja del producto (comprobar en ficha técnica), todos los datos en catálogo estan correctos salvo error tipográfico.

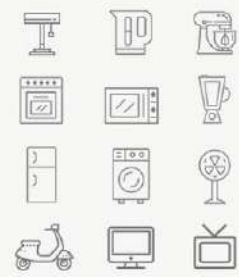

Diferentes aplicaciones



## Series Reloj temporizador Interior IP20



### Reloj temporizador

**RLJ-004**

Reloj temporizador mecánico blanco

PVPR 10,56 €



1 UDS



### Reloj temporizador

**RLJ-010**

Reloj temporizador mecánico mini blanco

PVPR 14,22 €

1 UDS



### Reloj temporizador digital

**RLJ-019**

Reloj temporizador digital blanco

1 UDS



### Reloj temporizador digital

**RLJ-011**

Reloj temporizador semanal digital

PVPR 28,59 €

1 UDS

DESCARGAR VIDEO



## Series Reloj temporizador Exterior IP44



### Reloj temporizador digital exterior IP44

**RLJ-018**

Reloj temporizador 24h digital exterior

 1 UDS



### Reloj temporizador exterior IP44

**RLJ-012**

Reloj temporizador mecánico blanco exterior

PVPR 19,74 €

 1 UDS



## Serie Portalámparas E27



		Ref	PVPR
PORTALÁMPARA E27	BLANCO	PORTLM-004	0,78€
PORTALÁMPARA E27	NEGRO	PORTLM-005	0,78€



Max. 4 lámparas de 30W

		Ref	PVPR
PORTALÁMPARAS	4xE27 - E40	ACLED-010	22,77€

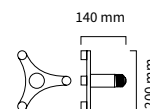

		Ref	PVPR
PORTALAMPARA REDUCTOR	E40 A E27	PORTLM-003	2,70€



		Ref	PVPR
PORTALÁMPARA E27 INCLINADO	BLANCO	MTE-0042	2,19€



		Ref	PVPR
PORTALÁMPARA E27 RECTO	BLANCO	MTE-0043	2,19€



## Serie Secadores



70-80db

**SECADO RÁPIDO Y SILENCIOSO**

Ref

PVPR

SECAMANOS

850W

SEC-001

47,88 €



Temp del aire: 38°C ± 15°C



Distancia detección: >50mm

Tiempo: < 5sec



70-80db



**SECADO RÁPIDO Y SILENCIOSO**

SECAMANOS BLANCO

1200W

SEC-002

105,30 €



Temp del aire: 60°C ± 20°C



Velocidad de viento: >30m/seg

Distancia de actuación: >140mm

Tiempo: <12sec



Botón cambio  
aire frío / caliente

Luz LED indicador  
aire caliente/frío



70-80db



**SECADO RÁPIDO Y SILENCIOSO**

SECAMANOS NEGRO

1200W

SEC-003

116,70 €



Temp del aire: 60°C ± 20°C



Velocidad de viento: >30m/seg

Distancia de actuación: >140mm

Tiempo: <12sec

\* Según la nueva normativa ERP ha habido un cambio en la medición de Lúmenes y vatios, pero sigue emitiendo la misma cantidad de luz.

A medida que vayan entrando los nuevos modelos con ERP se irá actualizando en catálogo y cajas de color.

Puede haber variación respecto la caja del producto (comprobar en ficha técnica), todos los datos en catálogo están correctos salvo error tipográfico.

## Extractores aseo



**Ultra silencioso - Ø100mm**

Ref **PVPR**

EXTRACTOR SILENT VACUUM V-1 BLANCO 4" 15W 180m³/h 36dB EXT-001 21,51€

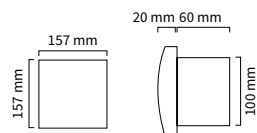

**Ultra silencioso - Ø100mm**

**ANTI-RETORNO OLORES**

EXTRACTOR SILENT VACUUM V-2 BLANCO 4" 15W 70m³/h 30dB EXT-002 58,38€

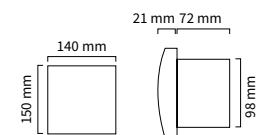

**Ultra silencioso - Ø100mm**

**ANTI-RETORNO OLORES**

EXTRACTOR SILENT VACUUM V-3 BLANCO 4" 12W 95m³/h 34dB EXT-003 41,52€

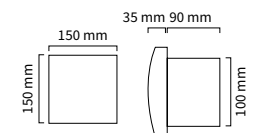

CON TEMPORIZADOR



**Ultra silencioso - Ø100mm - CON TEMPORIZADOR 1-25MIN ANTI-RETORNO OLORES**

EXTRACTOR SILENT VACUUM V-4 12W 70m³/h 30dB EXT-004 87,06€

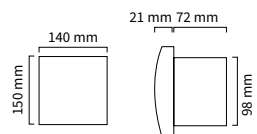

CON TEMPORIZADOR



**Ultra silencioso - Ø102mm - CON TEMPORIZADOR 1-30MIN ANTI-RETORNO OLORES**

EXTRACTOR SILENT VACUUM V-5 12W 66m³/h 39dB EXT-005 52,35€

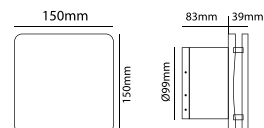



## Serie extractores cocina



**NEW!**

**Diametro tubo - Ø100mm**

65-70db



Ref

PVPR

**EXTRACTOR COCINA SILENT**

**70W 288m³/h 65dB**

EXT-006

169,56 €

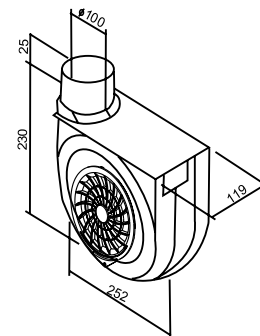

**NEW!**

**Diametro tubo - Ø95mm**

65-70db



Ref

PVPR

**EXTRACTOR COCINA SILENT**

**85W 210m³/h 65dB**

EXT-007

173,40 €

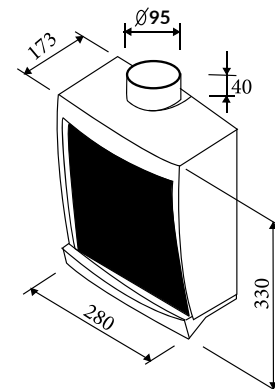

Bandeja y rejilla extraíble

\* Según la nueva normativa ERP ha habido un cambio en la medición de Lúmenes y vatios, pero sigue emitiendo la misma cantidad de luz.

A medida que vayan entrando los nuevos modelos con ERP se irá actualizando en catálogo y cajas de color.

Puede haber variación respecto la caja del producto (comprobar en ficha técnica), todos los datos en catálogo están correctos salvo error tipográfico.



**ATMOSS**  
ELECTRIC

 MATERIAL  
ELÉCTRICO

**AHORRA ESPACIO, hasta un 50% más en tú instalación**  
con los nuevos modelos de espacio reducido

**SERIE REDUCIDA**

**EJEMPLO DE INSTALACIÓN DE VIVIENDA DE 50 A 20CM**

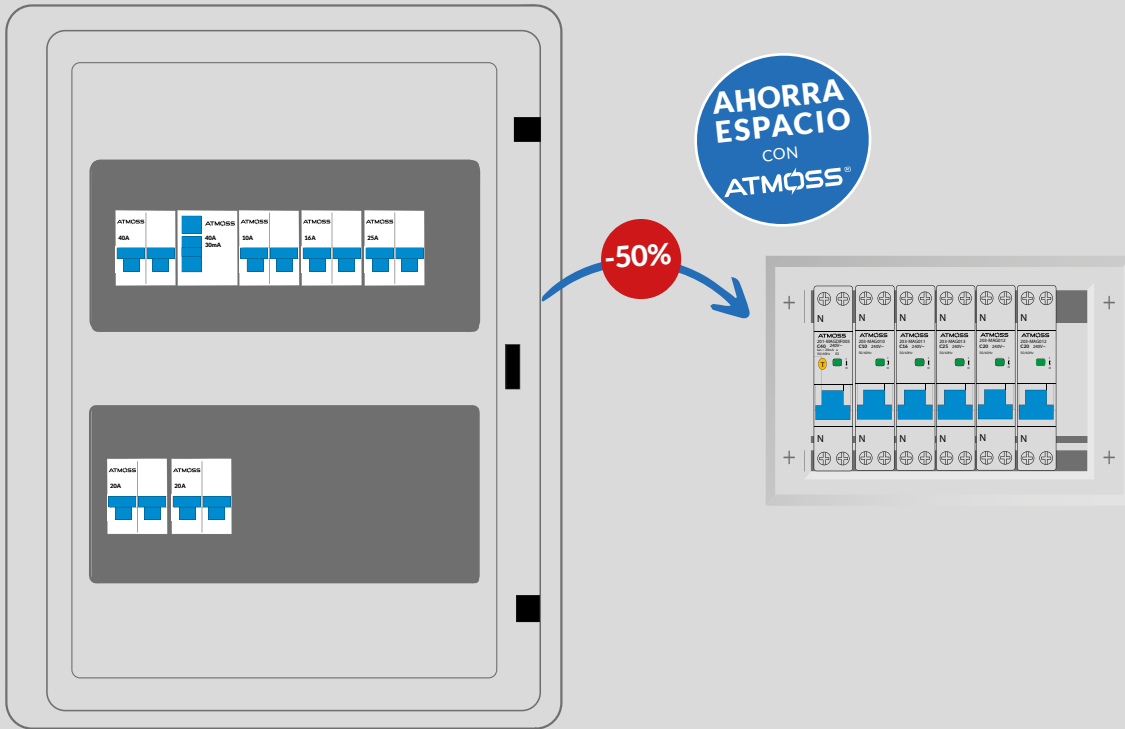

Ejemplo de instalación de vivienda:



**MAGNETOTÉRMICO GENERAL**  
2P 40A - 6kA - Curva C  
200-MAG028 **NEW!**



Magnetotérmico general + Diferencial  
1P+N 40A - 6kA 30mA Curva C  
201-MAGDIF003



**DIFERENCIAL**  
2P 40A - 6kA - TIPO AC  
200-DIF011

**PEQUEÑO INTERRUPTOR AUTOMÁTICO PIAS**



200-MAG023 -10A  
200-MAG024 -16A  
200-MAG026 -25A  
200-MAG025 -20A

**NEW!**



203-MAG010 -10A  
203-MAG011 -16A  
203-MAG013 -25A  
203-MAG012 -20A

## DIFERENCIALES

6KA /10KA SUPERINMUNIZADO SUPERINMUNIZADO REARMABLE

Protección residencial

¡ La **SEGURIDAD** de las personas garantizada !



**NEW PRICE!!**

2 POLOS - 6kA - TIPO AC 1 UDS

REF		PVPR
200-DIF010	25A 6kA 30mA	23,70 €
200-DIF011	40A 6kA 30mA	23,70 €
200-DIF012	63A 6kA 30mA	40,77 €

200-DIF013	25A 6kA 300mA	26,37 €
200-DIF014	40A 6kA 300mA	26,37 €
200-DIF015	63A 6kA 300mA	40,77 €

2 POLOS - 10kA - TIPO AC 1 UDS

REF		PVPR
100-DIF0036	40A 10kA 30mA	47,37 €

4 POLOS - 6kA - TIPO AC 1 UDS

REF		PVPR
200-DIF018	25A 6kA 30mA	46,08 €
200-DIF019	40A 6kA 30mA	46,08 €
200-DIF020	63A 6kA 30mA	47,37 €

200-DIF021	25A 6kA 300mA	46,08 €
200-DIF022	40A 6kA 300mA	46,08 €
200-DIF023	63A 6kA 300mA	47,37 €

4 POLOS - 10kA - TIPO AC 3 UDS

REF		PVPR
102-DIF0010	25A 10kA 30mA	51,96 €
102-DIF0011	40A 10kA 30mA	51,96 €
102-DIF0012	63A 10kA 30mA	51,96 €
102-DIF0007	80A 10kA 30mA	67,98 €
102-DIF0008	100A 10kA 30mA	74,79 €

101-DIF000001	25A 10kA 300mA	51,78 €
101-DIF000003	63A 10kA 300mA	57,93 €
101-DIF000004	80A 10kA 300mA	67,98 €
101-DIF000005	100A 10kA 300mA	74,79 €





Evita los cortes intempestivos  
**MAYOR SENSIBILIDAD** 

Diferencial  
**Superinmunizados**

2 POLOS - 6kA - TIPO A   1 UDS 

REF		PVPR
200-DIF027	16A 6kA 30mA	42,90 €
200-DIF016	40A 6kA 30mA	46,08 €
200-DIF028	63A 6kA 30mA	50,46 €
200-DIF017	40A 6kA 300mA	46,08 €



2 POLOS - 10kA - TIPO A   1 UDS 

100-DIF023	80A 10kA 30mA	68,13 €
100-DIF025	100A 10kA 30mA	55,20 €
100-DIF018	63A 10kA 300mA	67,98 €
100-DIF024	80A 10kA 300mA	68,13 €
100-DIF026	100A 10kA 300mA	81,78 €

4 POLOS - 6kA - TIPO A   1 UDS 

200-DIF024	40A 6kA 30mA	59,07 €
200-DIF026	63A 6kA 30mA	67,98 €
200-DIF025	40A 6kA 300mA	59,07 €
200-DIF029	63A 6kA 300mA	63,48 €



4 POLOS - 10kA - TIPO A   1 UDS 

100-DIF019	80A 10kA 30mA	74,40 €
100-DIF021	100A 10kA 30mA	81,78 €
100-DIF037	125A 10kA 30mA	144,36 €
100-DIF015	63A 10kA 300mA	67,98 €
100-DIF020	80A 10kA 300mA	74,40 €
100-DIF022	100A 10kA 300mA	81,78 €
100-DIF038	125A 10kA 300mA	144,36 €

**Funcionamiento del diferencial**



El indicador siempre estará en blanco, salvo cuando detecta una fuga de corriente residual.

Todos nuestros diferenciales, vienen marcados por normativa en la maneta con ON - OFF



El diferencial se dispara cuando detecta una fuga de corriente residual y aparece el indicador en rojo como se muestra en la imagen.

Cuando se pulsa el boton Test **T** se puede comprobar la fuga de corriente y el indicador se muestra en rojo.

Para ver el funcionamiento clickar sobre la flecha azul



Protección residencial

¡ La **SEGURIDAD** de las personas garantizada !

## DIFERENCIALES SUPER-INMUNIZADO SI

Protección residencial

¡Tu **HOGAR** o **FÁBRICA** mejor protegido!

**NEW!**



· Superinmunizado SI 2P

2 POLOS - 10kA - TIPO A SI   1 UDS

103-DIF001	40A	10kA	30mA	62,55 €
103-DIF002	40A	10kA	300mA	62,55 €

**NEW!**



· Superinmunizado SI 4P

4 POLOS - 10kA - TIPO A SI   1 UDS

103-DIF003	40A	10kA	30mA	73,80 €
103-DIF004	40A	10kA	300mA	73,80 €

## DIFERENCIALES REARMABLE

REARMABLE  SUPERINMUNIZADO REARMABLE



· Rearmable superinmunizado 2P

2 POLOS - 6kA - TIPO A   1 UDS 

100-DIF031	40A	6kA	300mA	193,62 €
------------	-----	-----	-------	----------

2 POLOS - 10kA - TIPO A 

100-DIF040	40A	10kA	30mA	193,62 €
100-DIF027	40A	10kA	300mA	258,90 €



· Rearmable superinmunizado 4P

4 POLOS - 6kA - TIPO A   1 UDS 

100-DIF033	40A	6kA	300mA	216,36 €
------------	-----	-----	-------	----------

4 POLOS - 10kA - TIPO A 

100-DIF028	40A	10kA	300mA	168,60 €
100-DIF041	40A	10kA	30mA	221,70 €



· Diferencial Rearmable 4P 10kA



4 POLOS - 10kA - TIPO AC   1 UDS 

100-DIF009	40A	10kA	30mA	306,63 €
------------	-----	------	------	----------

# INTERRUPTORES MAGNETOTÉRMICOS

Especial **SERIE - 6kA**



**1 POLO - 6kA - Curva C**  12 UDS 

REF		PVPR
200-MAG021	6A 6kA	6,45 €
200-MAG018	10A 6kA	4,44 €

**1P+N - 6kA - Curva C**  6 UDS 

REF		PVPR
200-MAG001	6A 6kA	5,43 €
200-MAG004	20A 6kA	5,43 €
200-MAG005	32A 6kA	5,43 €
200-MAG006	40A 6kA	6,15 €
200-MAG007	50A 6kA	6,15 €
200-MAG008	63A 6kA	6,15 €



**2P - 6kA - Curva C**  6 UDS

REF		PVPR
200-MAG022	6A 6kA	6,45 €
200-MAG023	10A 6kA	6,45 €
200-MAG024	16A 6kA	6,45 €
200-MAG025	20A 6kA	6,45 €
200-MAG026	25A 6kA	6,45 €
200-MAG027	32A 6kA	6,96 €
200-MAG028	40A 6kA	7,62 €
200-MAG029	50A 6kA	9,39 €
200-MAG030	63A 6kA	9,39 €

**4P - 6kA - Curva C**  3 UDS 

REF		PVPR
200-MAG010	6A 6kA	20,28 €
200-MAG011	10A 6kA	20,28 €
200-MAG012	16A 6kA	20,28 €
200-MAG013	20A 6kA	20,28 €
200-MAG019	25A 6kA	20,28 €
200-MAG014	32A 6kA	20,28 €
200-MAG015	40A 6kA	20,28 €
200-MAG016	50A 6kA	20,28 €
200-MAG017	63A 6kA	20,28 €



Protección residencial

Tu **HOGAR** o **FÁBRICA**  
mejor protegido !

\* Según la nueva normativa ERP ha habido un cambio en la medición de Lúmenes y vatios, pero sigue emitiendo la misma cantidad de luz. A medida que vayan entrando los nuevos modelos con ERP se irá actualizando en catálogo y cajas de color. Puede haber variación respecto la caja del producto (comprobar en ficha técnica), todos los datos en catálogo están correctos salvo error tipográfico.

## INTERRUPTORES MAGNETOTÉRMICOS

Especial **SERIE - 10kA**

Protección industria

¡ Tu **FÁBRICA**  
con mejor seguridad !

1 POLO - 10kA - Curva C

12 UDS



REF		PVPR
100-MAG0016	6A 10kA	6,75 €
100-MAG0007	10A 10kA	6,75 €
100-MAG0008	16A 10kA	6,75 €
100-MAG0009	20A 10kA	6,75 €
100-MAG0010	25A 10kA	6,75 €
100-MAG0011	32A 10kA	6,75 €
100-MAG0012	40A 10kA	6,75 €
100-MAG0019	63A 10kA	8,55 €

COMPATIBLE CON 100-BOB001/003

2 POLOS - 10kA - Curva C

6 UDS



REF		PVPR
100-MAG0013	6A 10kA	11,82 €
100-MAG0001	10A 10kA	11,82 €
100-MAG0002	16A 10kA	11,82 €
100-MAG0003	20A 10kA	11,82 €
100-MAG0004	25A 10kA	11,82 €
100-MAG0005	32A 10kA	11,82 €
100-MAG0006	40A 10kA	11,82 €
100-MAG0017	50A 10kA	13,44 €
100-MAG0018	63A 10kA	16,89 €

COMPATIBLE CON 100-BOB001/003

3 POLOS - 10kA - Curva C

4 UDS



REF		PVPR
000-MAG0001	10A 10kA	24,54 €
000-MAG0002	16A 10kA	24,54 €
000-MAG0008	20A 10kA	24,54 €
000-MAG0003	25A 10kA	24,54 €
000-MAG0004	32A 10kA	24,54 €
000-MAG0005	40A 10kA	24,54 €
000-MAG0006	50A 10kA	24,54 €
000-MAG0007	63A 10kA	24,54 €

COMPATIBLE CON 100-BOB001/003

3 POLOS - 10kA - Curva D

4 UDS





REF		PVPR
000-MAG0027	10A 10kA	33,90 €
000-MAG0028	16A 10kA	33,90 €
000-MAG0029	20A 10kA	33,90 €
000-MAG0030	25A 10kA	33,90 €
000-MAG0031	32A 10kA	33,90 €
000-MAG0032	40A 10kA	33,90 €
000-MAG0033	50A 10kA	33,90 €
000-MAG0034	63A 10kA	33,90 €

COMPATIBLE CON 100-BOB001/003

# INTERRUPTORES MAGNETOTÉRMICOS



Especial **SERIE - 10kA**

4 POLOS - 10kA - Curva C  3 UDS 



REF		PVPR
I01-MAG0009	6A 10kA	30,00 €
I01-MAG0001	10A 10kA	30,00 €
I01-MAG0002	16A 10kA	30,00 €
I01-MAG0003	20A 10kA	30,00 €
I01-MAG0004	25A 10kA	30,00 €
I01-MAG0005	32A 10kA	30,00 €
I01-MAG0006	40A 10kA	30,00 €
I01-MAG0007	50A 10kA	30,00 €
I01-MAG0008	63A 10kA	30,00 €

COMPATIBLE CON 100-BOB001/003



4 POLOS - 10kA - Curva D  3 UDS 



REF		PVPR
I04-MAG0018	10A 10kA	33,90 €
I04-MAG0019	16A 10kA	33,90 €
I04-MAG0020	20A 10kA	33,90 €
I04-MAG0021	25A 10kA	33,90 €
I04-MAG0022	32A 10kA	37,50 €
I04-MAG0023	40A 10kA	37,50 €
I04-MAG0024	50A 10kA	37,50 €
I04-MAG0025	63A 10kA	37,50 €
I04-MAG0026	100A 10kA	37,50 €

COMPATIBLE CON 100-BOB001/003

Especial **SERIE - 15kA**

4 POLOS - 15kA - Curva C  3 UDS 



REF		PVPR
I01-MAG0010	80A 15kA	140,37 €
I01-MAG0011	100A 15kA	157,92 €
I01-MAG0012	125A 15kA	175,47 €

NO COMPATIBLE CON 100-BOB001/003

Toda la gama de 10kA de es compatible con la bobina de tensión **100-BOB001 / 100-BOB003**

VER MÁS  
Bobina de tensión  
**Pág.390**



\* Según la nueva normativa ERP ha habido un cambio en la medición de Lúmenes y vatios, pero sigue emitiendo la misma cantidad de luz. A medida que vayan entrando los nuevos modelos con ERP se irá actualizando en catálogo y cajas de color. Puede haber variación respecto la caja del producto (comprobar en ficha técnica), todos los datos en catálogo estan correctos salvo error tipográfico.

# AHORRA ESPACIO, hasta un 50% más en tú instalación

con los nuevos modelos de espacio reducido

**SERIE REDUCIDA**

## EJEMPLO DE INSTALACIÓN DE VIVIENDA DE 50 A 20CM

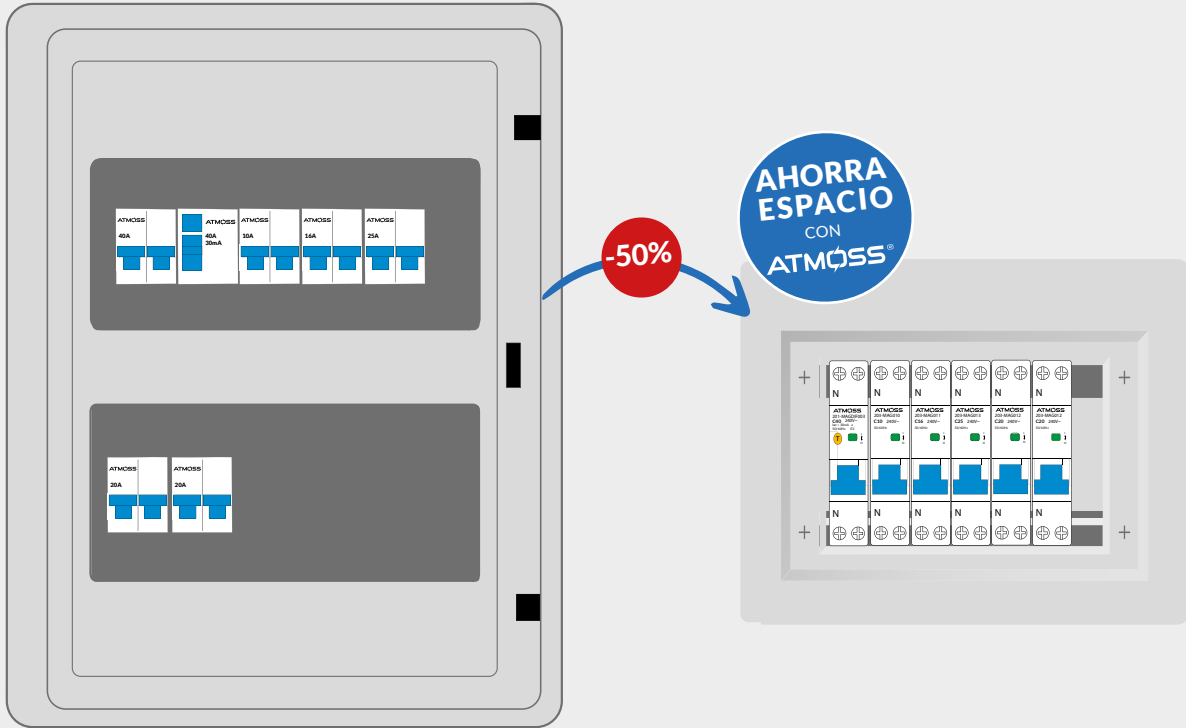

Ejemplo de instalación de vivienda:



**MAGNETOTÉRMICO GENERAL**  
2P 40A - 6kA - Curva C  
200-MAG028



**NEW!**  
Magnetotérmico general + Diferencial  
1P+N 40A - 6kA 30mA Curva C  
201-MAGDIF003



**DIFERENCIAL**  
2P 40A - 6kA - TIPO AC  
200-DIF011

**PEQUEÑO INTERRUPTOR AUTOMÁTICO PIAS**



- 200-MAG023 -10A
- 200-MAG024 -16A
- 200-MAG026 -25A
- 200-MAG025 -20A

- NEW!** 203-MAG010 -10A
- 203-MAG011 -16A
- 203-MAG013 -25A
- 203-MAG012 -20A

## Protectores para espacio reducido

Interruptores automáticos compactos.

Esta serie de interruptores compactos se presenta en las siguientes combinaciones de polos 1P+N en 1 módulos, 2P en 1 módulo, 3P y 4P en 2 módulos; con un poder de corte que va desde los 6 hasta los 10kA. Estas características le permiten cubrir aplicaciones tanto residenciales como industriales.

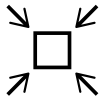

Solución compacta



Fácil de instalar



Versátil



18mm

### MAGNETOTÉRMICOS 2P REDUCIDOS



1P+N - 6kA DPN Curva C

 12 UDS

**2POLOS EN  
1 MÓDULO**

REF

PVPR

103-MAG0007	6A DPN 6kA	10,05 €
103-MAG0001	10A DPN 6kA	10,05 €
103-MAG0002	16A DPN 6kA	10,05 €
103-MAG0003	20A DPN 6kA	10,05 €
103-MAG0004	25A DPN 6kA	10,05 €
103-MAG0005	32A DPN 6kA	10,89 €
103-MAG0006	40A DPN 6kA	10,89 €

DISEÑO Y FORMATO PARA LA GAMA DE 10kA

COMPATIBLE CON 100-BOB001/003



1P+N - 6kA DPN SET - Curva C

 12 UDS

**2POLOS EN  
1 MÓDULO**

REF

PVPR

203-MAG010	10A DPN SET 6kA	10,05 €
203-MAG011	16A DPN SET 6kA	10,05 €
203-MAG012	20A DPN SET 6kA	10,05 €
203-MAG013	25A DPN SET 6kA	10,05 €
203-MAG014	32A DPN SET 6kA	10,89 €
203-MAG015	40A DPN SET 6kA	10,89 €

DISEÑO Y FORMATO PARA LA GAMA DE 6kA

### MAGNETOTÉRMICOS 4P REDUCIDOS



4P - 6kA - Curva C

 6 UDS

**4POLOS EN  
2 MÓDULOS**

REF

PVPR

200-MAG031	10A 6kA	86,94 €
200-MAG032	16A 6kA	86,94 €
200-MAG033	20A 6kA	86,94 €
200-MAG034	25A 6kA	86,94 €
200-MAG035	32A 6kA	86,94 €
200-MAG036	40A 6kA	86,94 €



\* Según la nueva normativa ERP ha habido un cambio en la medición de Lúmenes y vatios, pero sigue emitiendo la misma cantidad de luz.

A medida que vayan entrando los nuevos modelos con ERP se irá actualizando en catálogo y cajas de color.

Puede haber variación respecto la caja del producto (comprobar en ficha técnica), todos los datos en catálogo están correctos salvo error tipográfico.

DIFERENCIALES REDUCIDO

2 POLOS EN  
1 MÓDULO

 1 UDS



Diferencial Superinmunizado Tipo A 

IP + N - Tipo A

REF				PVPR
I00-DIF042	25A	10kA	10mA	
I00-DIF034	40A	10kA	30mA	50,58 €



4 POLOS EN  
2 MÓDULOS

 1 UDS



Diferencial Superinmunizado Tipo A 

3P + N - Tipo A - 2 MÓDULOS

REF				PVPR
I00-DIF035	40A	10kA	30mA	125,61 €



\* Con enclavamiento para candado.

DIFERENCIALES REDUCIDO

2 MÓDULOS

Magneto Diferencial Superinmunizado Tipo A 

IP+N - 10kA 30mA - Curva C

REF			PVPR
I01-MGDIF0008	10A	10kA	67,20 €
I01-MGDIF0009	16A	10kA	67,20 €
I01-MGDIF0010	25A	10kA	67,20 €



2 MÓDULOS

Magneto Diferencial Tipo AC 

2P - 30mA - Curva C 

REF			PVPR
I01-MGDIF0002	16A	30mA	52,47 €
I01-MGDIF0003	20A	30mA	52,47 €
I01-MGDIF0004	25A	30mA	52,47 €
I01-MGDIF0007	32A	30mA	52,47 €
I01-MGDIF0006	40A	30mA	55,98 €



4 MÓDULOS

Magneto Diferencial Superinmunizado Tipo A 

3P+N - 30mA - 6kA

REF				PVPR
201-MGDIF004	16A	30mA		99,21 €
201-MGDIF005	20A	30mA		99,21 €
201-MGDIF006	25A	30mA		99,21 €
201-MGDIF007	32A	30mA		99,21 €
201-MGDIF008	40A	30mA		99,21 €



**2POLOS EN  
1 MÓDULO**



*Magneto Diferencial Superinmunizado Tipo A*



*IP+N - 6kA 30mA - Curva C*

REF		PVPR
201-MGDIF001	16A 6kA	42,90 €
201-MGDIF002	25A 6kA	42,90 €
201-MGDIF003	40A 6kA	47,58 €

*IP+N - 6kA 10mA*

REF		PVPR
100-DIF039	16A 6kA 10mA	53,40 €

**Electromagnético - Función AFDD**



*Magneto Diferencial Superinmunizado Tipo A*



301-MGDIF000 10A 6kA 10mA 62,55 €

*IP+N - 6kA 30mA - Curva C*

301-MGDIF001	10A 6kA	62,55 €
301-MGDIF002	16A 6kA	62,55 €
301-MGDIF003	20A 6kA	62,55 €
301-MGDIF004	25A 6kA	62,55 €
301-MGDIF005	32A 6kA	62,55 €
301-MGDIF006	40A 6kA	62,55 €



*IP+N - 6kA 300mA - Curva C*

301-MGDIF007	10A 6kA	
301-MGDIF008	16A 6kA	62,55 €
301-MGDIF009	20A 6kA	
301-MGDIF010	25A 6kA	
301-MGDIF011	32A 6kA	
301-MGDIF012	40A 6kA	62,55 €

• Descripción

Un Dispositivo de **Detección de Fallos de Arco Eléctrico (AFDD)** es un equipo avanzado diseñado para identificar arcos eléctricos defectuosos en los circuitos y desconectar la parte afectada, previniendo potenciales incendios. Estos arcos pueden originarse por conexiones sueltas, cables dañados o aislamiento defectuoso, representando un riesgo significativo de incendio.

• Características:

- **Protección integral:** Combina protección contra fallos de arco eléctrico, cortocircuitos, sobrecargas y corrientes residuales en un solo dispositivo.
- **Detección sensible:** Utiliza tecnología digital avanzada para identificar fallos de arco con alta precisión, superando las directrices aplicables y evitando disparos involuntarios.
- **Indicadores de estado:** Incorpora LEDs que muestran el estado del dispositivo y el motivo del disparo, facilitando la resolución de problemas.
- **Fácil instalación:** Compatible con peines de conexión, permite una instalación sencilla y flexible en sistemas nuevos o existentes.

# APARAMENTA GAMA SOLAR



El **interruptor magnetotérmico de Gama Solar** es una solución avanzada diseñada específicamente para proteger instalaciones solares fotovoltaicas.

Este dispositivo combina protección térmica y magnética, salvaguardando los sistemas eléctricos contra sobrecargas y cortocircuitos en aplicaciones solares de corriente continua (DC)

• **Beneficios:**

- **Protección confiable:** Salvaguarda los componentes del sistema solar contra daños eléctricos.
- **Durabilidad:** Diseñado para soportar más de 1500 operaciones mecánicas, asegurando una larga vida útil.
- **Facilidad de instalación:** Su montaje en carril DIN y compatibilidad con cables de hasta 25 mm<sup>2</sup> simplifican su integración en diversas configuraciones.



## MAGNETOTÉRMICOS 2P GAMA SOLAR

REF	Voltaje	Capacidad de corte	Corriente nominal	Precio
200S-MAG031	500V DC	10kA	6A	19,56 €
200S-MAG032	500V DC	10kA	10A	19,56 €
200S-MAG033	500V DC	10kA	16A	19,56 €
200S-MAG034	500V DC	10kA	25A	19,56 €
200S-MAG035	500V DC	10kA	32A	19,56 €
200S-MAG036	500V DC	10kA	40A	19,56 €
200S-MAG037	500V DC	10kA	50A	20,88 €
200S-MAG038	500V DC	10kA	63A	20,88 €



## MAGNETOTÉRMICOS 4P GAMA SOLAR

REF	Voltaje	Capacidad de corte	Corriente nominal	Precio
400S-MAG001	1000V DC	10kA	6A	39,15 €
400S-MAG002	1000V DC	10kA	10A	39,15 €
400S-MAG003	1000V DC	10kA	16A	39,15 €
400S-MAG004	1000V DC	10kA	25A	39,15 €
400S-MAG005	1000V DC	10kA	32A	39,15 €
400S-MAG006	1000V DC	10kA	40A	39,15 €
400S-MAG007	1000V DC	10kA	50A	41,82 €
400S-MAG008	1000V DC	10kA	63A	41,82 €

Es un **dispositivo de protección contra sobretensiones** diseñado para sistemas solares fotovoltaicos. Su función principal es proteger los componentes eléctricos de la instalación frente a picos de tensión causados por eventos como descargas atmosféricas o fluctuaciones en la red eléctrica.

Este protector actúa como una barrera que desvía las sobretensiones hacia tierra, evitando que alcancen y dañen los equipos sensibles del sistema solar.



### PROTECTOR SOBRETENSIÓN DC SOLAR 2P

REF

PRT-007	1000V DC	20/40kA	37,98 €
---------	----------	---------	---------



### PROTECTOR SOBRETENSIÓN DC SOLAR 3P

REF

PRT-008	1200V DC	20/40kA	56,94 €
---------	----------	---------	---------

MAGNETOTÉRMICO CON PROTECTOR  
COMBINADO SOBRETENSIÓN  
**TRANSITORIO Y PERMANENTE**

PROTEGE TUS INSTALACIONES DE  
**SOBRETENSIONES Y CAIDAS DE RAYOS**

APARAMENTA  
**PROTECTORES**



2P - 3MÓDULOS

1 UDS



REF

PVPR

PRT-020	2P 16A 10KA	79,17 €
PRT-021	2P 20A 10KA	79,17 €
PRT-022	2P 25A 10KA	79,17 €
PRT-023	2P 32A 10KA	79,17 €
PRT-005	2P 40A 10KA	79,17 €
PRT-024	2P 50A 10KA	79,17 €
PRT-025	2P 63A 10KA	79,17 €



4P - 6MÓDULOS

1 UDS



REF

PVPR

PRT-014	4P 16A 10KA	123,69 €
PRT-015	4P 20A 10KA	123,69 €
PRT-016	4P 25A 10KA	123,69 €
PRT-018	4P 32A 10KA	123,69 €
PRT-006	4P 40A 10KA	123,69 €
PRT-019	4P 50A 10KA	123,69 €
PRT-017	4P 63A 10KA	123,69 €

NORMA: EN50550 / IEC61643-1 / IEC60898-1.

LVD 2014/35/EU  
ROHS 2011/65/EU

- Tiempo de actuación contra sobretensiones permanentes

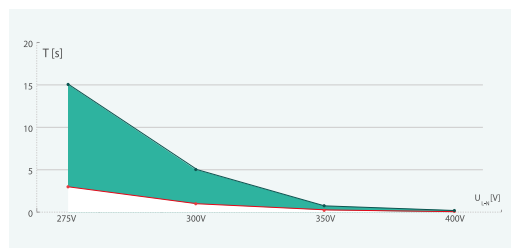

Curva de tensión / tiempo según normativa UNE-EN-50550

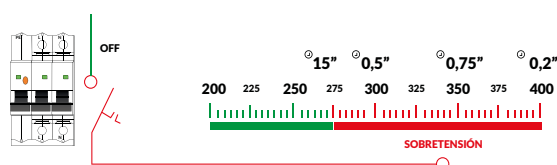
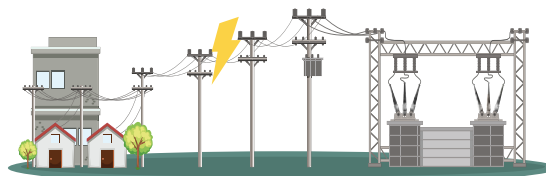

PROTECTOR DIGITAL

PERMANENTE **SOBRETENSIÓN - SUBTENSIÓN**



PRT-011 2P 63A

26,85 €



PRT-026 4P 80A

87,09 €

● Protector sobretensión trifásico



Protector / medidor sobretensión trifásico Tuya

MED-004

Protector sobretensión TUYA  
3P+N - 100A - 4W

PVPR 217,32 €

● Protector sobretensión transitorias



**Protector sobretensión - 2 POLOS**

 2 UDS

**DESCARGAR**  
FICHA TECNICA



**PRT-001**

PROTECTOR CONTRA  
SOBRETENSIONES TRANSITORIAS

C2-40KA/275V 1P+NPE

PVPR 36,81 €



**Protector sobretensión - 4 POLOS**

 1 UDS

**DESCARGAR**  
FICHA TECNICA



**PRT-002**

PROTECTOR CONTRA  
SOBRETENSIONES TRANSITORIAS

C2-40KA/400V 3P+NPE

PVPR 67,89 €

● Protector sobretensión individual



**Protector sobretensión individual**

 1 UDS

**DESCARGAR**  
FICHA TECNICA



**PRT-013**

PROTECTOR SOBRETENSIÓN  
INDIVIDUAL

Uc: 320Vac - I<sub>max</sub>: 10Ka - I<sub>n</sub>: 5Ka - IP67

PVPR 13,68 €

● Protectores



**Protector permanente Max y Mín**

**100-BOB003**

PROTECTOR PERMANENTE BOBINA  
DE MÁXIMA Y MÍNIMA 230V  
para MAG 10KA

PVPR 35,94 €

 8 UDS

**DESCARGAR**  
FICHA TECNICA



**Bobina de tensión - Protección tensión max**

**100-BOB001**

TIPO AC 230V -4M

PVPR 55,80 €

**100-BOB002**

TIPO AC 400V -7M

PVPR 107,88 €

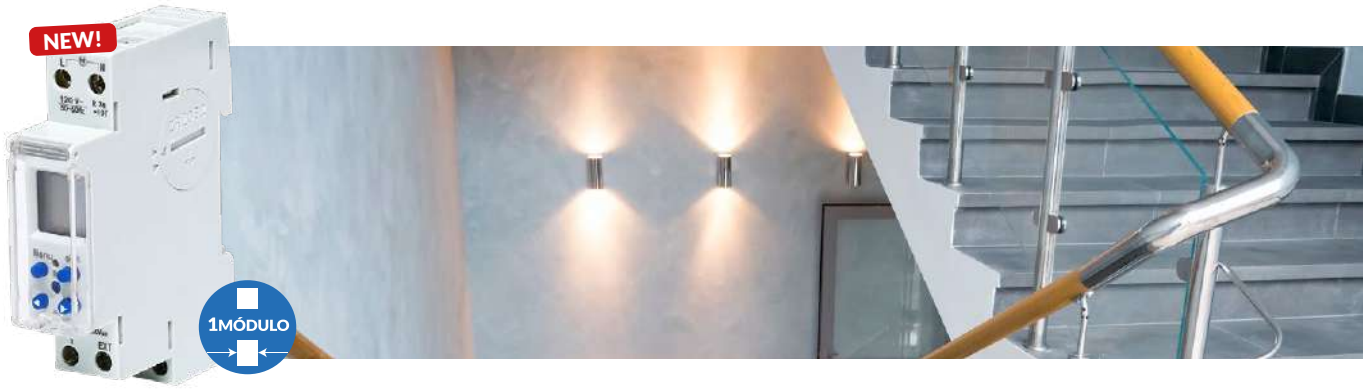

● **Reloj horario**

**INTERRUPTOR HORARIO DIGITAL**

Compatible con pila CR2032

Módulo estrecho 1 módulo

**Programa tus dispositivos eléctricos con facilidad.**

Es adecuado para uso particular de las siguientes tareas:

- Iluminación de áreas privadas e industriales,
- Iluminación de calles y escaparates
- Regulación de aire acondicionado
- Motores, bombas, plantas y maquinaria, así como para simular presencia, etc.

- Interruptor de disparo externo
- Programa de cuenta atrás (1s~59m59s)
- Programa diario y semanal.
- 32 programas de pulso (1s~59m59s)
- Fecha y hora preestablecidas
- 16 grupos de programa ON/OFF
- Mostrar año/mes/día/hora/minuto
- Encendido/Apagado permanente
- Totalmente operable sin conexión a la red eléctrica
- Reemplazo de batería de litio y batería recargable

	REF		PVPR
INTERRUPTOR HORARIO DIGITAL	RLJ-013	16A 230V IP20	55,50€ 



- Programación digital
- Pantalla LCD
- 8 Programas dia/semana
- 16A 3680w
- 230v 50Hz
- Carga inductiva es de 8A 1800 W

	REF		PVPR
RELOJ TEMPORIZADOR DIGITAL	RLJ-014	16A 3680w 230V	77,94€

\* Según la nueva normativa ERP ha habido un cambio en la medición de Lúmenes y vatios, pero sigue emitiendo la misma cantidad de luz. A medida que vayan entrando los nuevos modelos con ERP se irá actualizando en catálogo y cajas de color. Puede haber variación respecto a la caja del producto (comprobar en ficha técnica), todos los datos en catálogo están correctos salvo error tipográfico.

## ● Reloj modular

**Reloj modular**

1 UDS

DESCARGAR   
FICHA TECNICA**RLJ-001**

RELOJ MODULAR CON RESERVA

PVPR 39,57 €

## ● Minutero escalera

**Minutero escalera**

1 UDS

DESCARGAR   
FICHA TECNICA**RLJ-003**

MINUTERO ESCALERA CON INDICADOR LED

PVPR 35,94 €

## ● Reloj modular

El reloj modular se presenta como el **programador ideal para la semana**, aplicaciones estacionarias o que necesitan variar su horario de funcionamiento a lo largo del año,...

NEW!

**Reloj modular digital** **RLJ-005**  
RELOJ CON RESERVA  
1 CANAL - 16A

PVPR 49,14 €

1 UDS

**Dispone de:** Interruptor horario digital  
con programa semanal

Batería de litio 3.6V, 1.2Ah

52 Programas

 Cambio automático de horario  
Verano/Invierno

Pantalla LCD retroiluminada

Modo vacaciones

NEW!

**Reloj modular digital****RLJ-006**  
RELOJ CON RESERVA  
2 CANALES - 16A

PVPR 55,65 €

1 UDS

● **Reloj astronómico** 

El reloj *calcula automáticamente la hora de salida y de puesta del sol* en función de la posición geográfica en la que está ubicado. Esto nos permite ahorrar energía en tu instalación.

**NEW!**



**Reloj astronómico digital** 

**RLJ-009**  
RELOJ DIGITAL CON RESERVA  
**1 CANAL - 16A**

PVPR 55,65 €

 1 UDS

**NEW!**



**Reloj astronómico digital** 

**RLJ-007**  
RELOJ DIGITAL CON RESERVA  
**2 CANALES - 16A**

PVPR 63 €

 1 UDS

**NEW!**



**Reloj astronómico WiFi** 

**RLJ-008**  
RELOJ WiFi CON RESERVA  
**1 CANAL - 16A**

PVPR 50,55 €

 1 UDS

**Dispone de:**

 Programador astronómico y programador anual/semanal

Reserva de marcha 10 años (batería de litio)

 80 programas

 Tapa precintable, fácil configuración con 4 botones

 Cambio automático de horario de verano/invierno

 Pantalla LCD con retroiluminación (puede desactivarse)

 Modo vacaciones

 Modo aleatorio

 2 canales puede asignarse un programa individual a cada canal

 Montaje en carril din, 2 módulos



● **Interruptor - conmutador**



**Interruptor - Conmutador Carril DIN**

 1 UDS

**DESCARGAR**   
FICHA TÉCNICA

**INT-001**

1P 25A

PVPR 8,85 €

● **Medidor de energía** ⚡

**NEW!**



**Medidor de energía**

 1 UDS



MED-001  
Medidor de energía 1P 220V CON LUZ

PVPR 35,10 €

- Gran fiabilidad
- Peso ligero
- Pequeño volumen
- La cáscara está hecha de material ignífugo de nylon con alta resistencia al fuego y aislamiento duradero
- Instalación en carril DIN 35mm

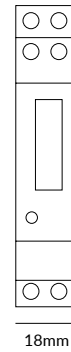

18mm

**NEW!**



**Medidor de energía**

 1 UDS

MED-003  
Medidor de energía 4P 400V DIGITAL

PVPR 149,40 €

· **Funciones y características**

- Montaje en carril DIN estándar de 35 mm.
- Medición de alta precisión de la energía activa de nivel 1 y la energía reactiva de nivel 2.
- Pantalla con retroiluminación LCD.
- LED indica salida de pulso, salida de pulso pasiva.
- Varios parámetros pueden consultarse rápidamente mediante las teclas.
- Con energía bidireccional activa, medición de energía reactiva, visualización de corriente, voltaje, factor de potencia y otras funciones.

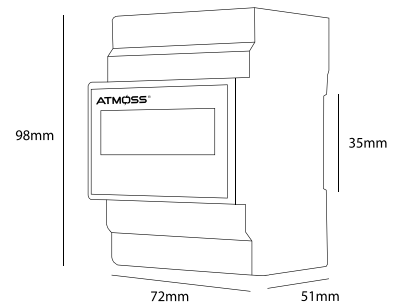

● **Contactores modular**



**Contactor modular 2 POLOS**

**105-CON002**  
2P  
25 A

**105-CON003**  
2P  
40 A

**105-CON009**  
2P  
63 A

PVPR 18,84 €

PVPR 33,63 €

PVPR 33,63 €

 12 UDS

 6 UDS

 6 UDS

**DESCARGAR**   
FICHA TECNICA



**Contactor modular 4 POLOS**

**105-CON004**  
4P  
25 A

**105-CON005**  
4P  
40 A

**105-CON006**  
4P  
63 A

PVPR 47,34 €

PVPR 47,34 €

PVPR 47,34 €

 6 UDS

 4 UDS

 4 UDS

**DESCARGAR**   
FICHA TECNICA



## INTERRUPTOR PROTECTOR DE MOTOR

Diseñado para la protección de motores eléctricos contra sobrecargas y cortocircuitos, permitiendo también el arranque directo de motores.

- Características:

- **Seguridad y fiabilidad:** Fabricado bajo estándares IEC 60947-2/60947-4, garantiza una protección precisa y duradera.
- **Amplio rango de ajustes:** Compatible con motores que operan en rangos de corriente entre 0.1 y 32 A.
- **Versatilidad:** Admite voltajes de hasta 690 V y frecuencias de 50/60 Hz, adecuado para aplicaciones industriales y comerciales.
- **Fácil instalación:** Montaje rápido en riel DIN, con diseño compacto (77x45x44.5 mm) que optimiza el espacio.
- **Protección avanzada:** Terminales con protección IP20, evitando contactos accidentales para mayor seguridad.

- Casos de uso:

Empresas e instalaciones que buscan proteger motores eléctricos, prolongando su vida útil y evitando paradas no planificadas.



INTM-001	690V 0,63 - 1A	37,50 €
INTM-002	690V 1,0 - 1,6A	37,50 €
INTM-003	690V 1,6 - 2,5A	37,50 €
INTM-004	690V 2,5 - 4,0A	37,50 €
INTM-005	690V 4,0 - 6,3A	37,50 €
INTM-006	690V 6,0 - 10A	37,50 €
INTM-007	690V 9,0 - 14A	37,50 €
INTM-008	690V 13 - 18A	37,50 €
INTM-009	690V 17 - 23A	37,50 €
INTM-010	690V 24 - 32A	37,50 €

 1 UDS

DESCARGAR   
FICHA TÉCNICA

● Fusible y portafusible



**FUS-001** *1000V DC CON LUZ 32A MÁX* 5,82 €  
Ø10 x 38mm

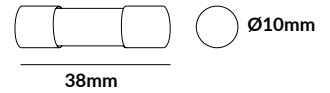

**FUS-002** *1000V DC 16A* 3,30 €  
Ø10 x 38mm

 10 UDS  600 UDS

Capacidad de interrupción: 20kA  
Constante de tiempo: 1-3 ms

● Accesorios



**Base de enchufe SCHUKO**  6 UDS

DESCARGAR   
FICHA TECNICA

**106-BASE001**

BASE DE ENCHUFE DE CARRIL DIN SCHUKO 16A

PVPR 6,81 €

**NEW!**  
**PEINES DE CONEXIÓN**

 5 UDS en blister plastificado

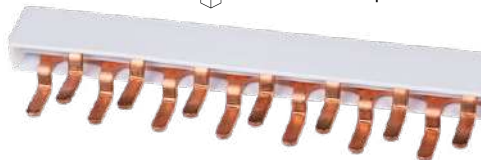

**SOLAMENTE VÁLIDO PARA LOS MAGNETOS DPN 203-MAG**

**TAPAS FINALES NO INCLUIDAS**

**PINI-001** *1P+N 63A 108PINS* 36,48 €

Corriente (A) 63A  
Sección transversal (mm<sup>2</sup>) 10mm<sup>2</sup>  
Espesor (mm) 1,5mm

**Accesorio**

TAPA FINAL DE CONEXIÓN - PIN1+N 0,10€

 10 UDS

1mt longitud

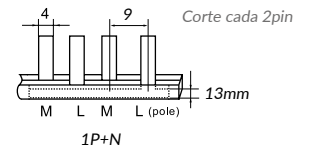

 5 UDS en blister plastificado



**2 TAPAS FINALES INCLUIDAS**

**PIN2-001** *2P 63A 54PINS* 26,70 €

Corriente (A) 63A  
Sección transversal (mm<sup>2</sup>) 10mm<sup>2</sup>  
Espesor (mm) 1,5mm

**Accesorio**

TAPA FINAL DE CONEXIÓN - PIN2 0,09€

 10 UDS

1mt longitud

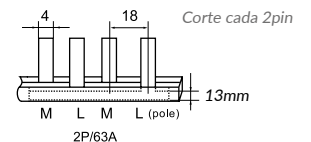

 5 UDS en blister plastificado

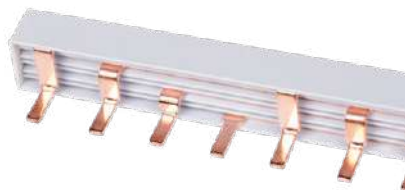

**2 TAPAS FINALES INCLUIDAS**

**PIN4-001** *4P 63A 56PINS* 51,48 €

Corriente (A) 63A  
Sección transversal (mm<sup>2</sup>) 10mm<sup>2</sup>  
Espesor (mm) 1,5mm

**Accesorio**

TAPA FINAL DE CONEXIÓN - PIN4 0,14€

 10 UDS

1mt longitud

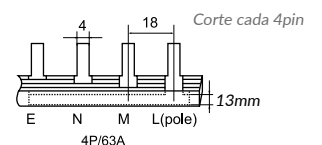



Serie aparamenta domótica

## APARAMENTA DOMÓTICA

**Control total** de la electricidad a distancia **DESDE TU SMARTPHONE**

**ON/OFF**  
A DISTANCIA

**APP CONTROL  
REMOTO**

COMPATIBLE  
CON APP **tuya**

**Transforma tu espacio con tecnología inteligente y eficiente!**

La aparamenta eléctrica domótica combina seguridad, eficiencia y conectividad para llevar la gestión de la electricidad a un nuevo nivel. Con soluciones inteligentes como interruptores, medidores de consumo, magnetotérmicos,... con conectividad WiFi, es posible controlar y monitorizar la instalación eléctrica de forma remota con la aplicación **tuya** optimizando el consumo y mejorando la seguridad del hogar o negocio.

### Características Principales:

- **Control Remoto:** Maneja y supervisa los dispositivos desde el móvil o asistente de voz.
- **Automatización:** Inteligente: Programa encendidos y apagados según horarios o consumo.
- **Monitorización en Tiempo Real:** Accede a datos de consumo para optimizar el ahorro energético.
- **Protección Avanzada:** Magnetotérmicos y diferenciales con alertas en caso de fallos eléctricos.
- **Fácil Instalación y Configuración:** Compatible con redes WiFi y sistemas domóticos.

### Beneficios:

- **Mayor Seguridad:** Previene sobrecargas y cortocircuitos con alertas en tiempo real.
- **Eficiencia Energética:** Reduce el consumo eléctrico con una gestión optimizada.
- **Confort y Comodidad:** Automatiza la iluminación y el funcionamiento de los dispositivos eléctricos.
- **Conectividad Total:** Integra tu instalación con sistemas inteligentes y plataformas IoT.

\* Según la nueva normativa ERP ha habido un cambio en la medición de Lúmenes y vatios, pero sigue emitiendo la misma cantidad de luz.

A medida que vayan entrando los nuevos modelos con ERP se irá actualizando en catálogo y cajas de color.

Puede haber variación respecto la caja del producto (comprobar en ficha técnica), todos los datos en catálogo están correctos salvo error tipográfico.

● Interruptor medidor 2P WiFi



INT-002

Interruptor medidor Smart Wifi  
2P WiFi 63A

PVPR 78,60 €

1 UDS

Inicio

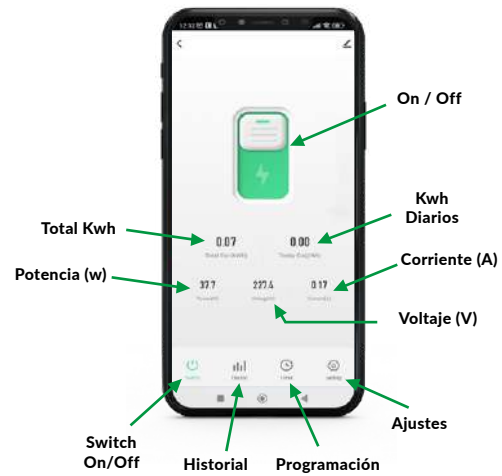

Estadísticas



Programación



Ajustes Programación



Ajustes

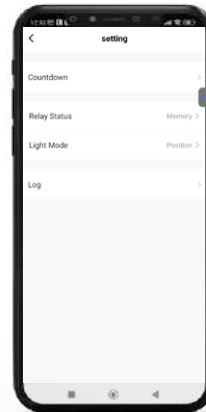

Ajustes Programación

- **Horario:** El dispositivo puede encenderse y apagarse en momentos determinados.
- **Amanecer:** El equipo se enciende/apaga antes del amanecer, durante el amanecer y después del amanecer.
- **Atardecer:** El equipo está encendido/apagado antes del atardecer, durante el atardecer y después del atardecer.
- **Circular:** El equipo puede encenderse/apagarse repetidamente durante el periodo establecido.

● Magnetotérmico Rearmable WiFi



**NEW!**



**Magnetotérmico Rearmable**

**2P - 6kA - Curva C**

500-MAG001	10A	6kA	89,85 €
500-MAG002	16A	6kA	89,85 €
500-MAG003	20A	6kA	89,85 €
500-MAG004	25A	6kA	89,85 €
500-MAG005	32A	6kA	89,85 €
500-MAG006	40A	6kA	89,85 €



**NEW!**



**4P - 6kA - Curva C**

504-MAG001	16A	6kA	113,85 €
504-MAG002	20A	6kA	113,85 €
504-MAG003	25A	6kA	113,85 €
504-MAG004	32A	6kA	113,85 €
504-MAG005	40A	6kA	113,85 €



**NEW!**



**Diferencial / Magnetotérmico Rearmable Super-Inmunizado Combinado VIGI**



**IP+N - Tipo A - 30mA**













500-DIF001	16A	30mA	135,12 €
500-DIF002	20A	30mA	135,12 €
500-DIF003	25A	30mA	135,12 €
500-DIF004	40A	30mA	135,12 €
500-DIF004	32A	30mA	135,12 €
500-DIF005	32A	30mA	135,12 €



# LA ENERGÍA EN TUS MANOS

- **Dispositivo 10 en 1**
- VIDEO VINCULACIÓN 
- ESCANEAR FICHA TÉCNICA 

Importante activar para la vinculación rápida  **Bluetooth**

-  Protección contra **SOBRETENSIÓN PERMANENTE**
-  Protección contra **BAJOVOLTAJE**
-  Protección contra **SOBREINTENSIDAD**
-  Medidor de **Kwh**
-  **Contador** de energía
-  Amperimetro
-  Protección contra **FUGAS Diferencial**
-  Interruptor **Wifi ON/OFF**
-  **Medidor** de tensión
-  Función **PREPAGO**
-  Control por **VOZ**
-  Pantalla de **visualización**



**MED-002**  
Dispositivo de protección ajustable de tensión (PERMANENTE), corriente, y fugas con contador de kilovatios hora.

PVPR 64,29€

- El valor de **protección contra permanentes** para ajustarlo usted mismo.
- **Protección contra sobrecorriente** configurable por el usuario.
- La **protección contra fugas** la puede ajustar usted mismo.
- Visualización en **tiempo real** de la **potencia**.
- Función **prepago**.
- Control por **voz**
- Programa **horarios**
- Mide el **consumo** de tu vivienda vacacional o alquiler desde el **Check-in y Check-out**
- **Función autoencendido**. El dispositivo se restablece automáticamente.







**Funciones**

-  Voltaje
-  **Vida** eléctrica y mecánica
-  Valor de protección contra **sobretensión**
-  Valor de protección contra **subtensión**
-  Valor de protección contra **fugas**

**Parámetros técnicos**

- 85-300 V
- ≤10.000 ciclos
- 120-300 V **REGULABLE**  
DEFECTO 275 V
- 85-200 V **REGULABLE**  
DEFECTO 160V
- 10-99m A  
DEFECTO 30mA  
**REGULABLE**

**Funciones**

-  **Dimensiones**
-  Valor de protección contra **sobreintensidad**
-  **Tiempo** de acción
-  **Consumo** de energía

**Parámetros técnicos**

- 100\*36mm
- 1-63A **REGULABLE**
- <15
- <2w

**FUNCIÓN PREPAGO**



- Puedes controlar el consumo de tu vivienda desde tu smartphone.
- Limitar el consumo.
- Activar o desactivar la electricidad.



**Uso ideal para:**

- Hoteles
- Alquiler vacacional
- Alquiler vivienda
- Carga de coches
- Trasteros



## Esquema eléctrico

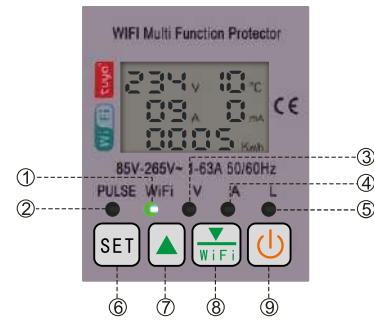
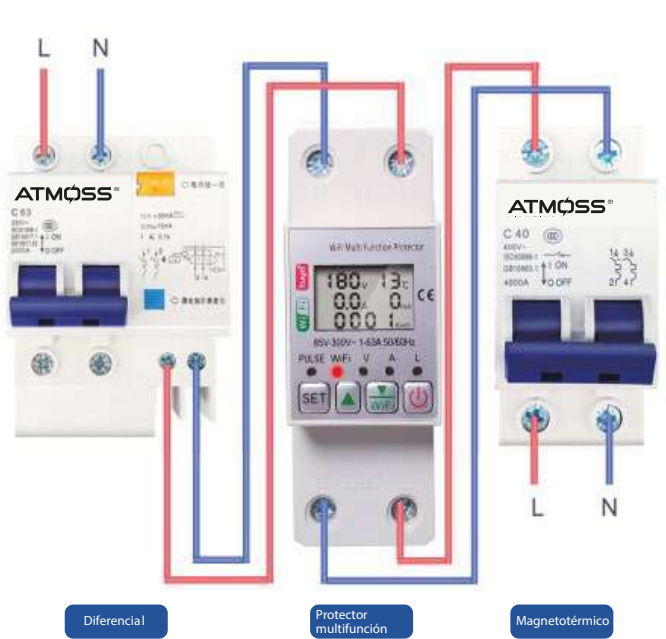

1. Indicador WIFI
2. Indicador de pulso del contador de kilovatios hora
3. Indicador de alarma de sobretensión/subtensión
4. Indicador de alarma de sobreintensidad
5. Indicador de alarma de fuga
6. Tecla Set: pulse para acceder a la interfaz de configuración
7. Tecla de ajuste +  
Tecla Test: Pulsación prolongada durante 3 segundos para comprobar la fuga
8. Tecla de ajuste -  
Tecla Wifi: Pulsación larga durante 5 segundos para configurar el Wifi
9. Tecla ON/OFF

Tiempo de disparo según la norma UNE-EN-5050

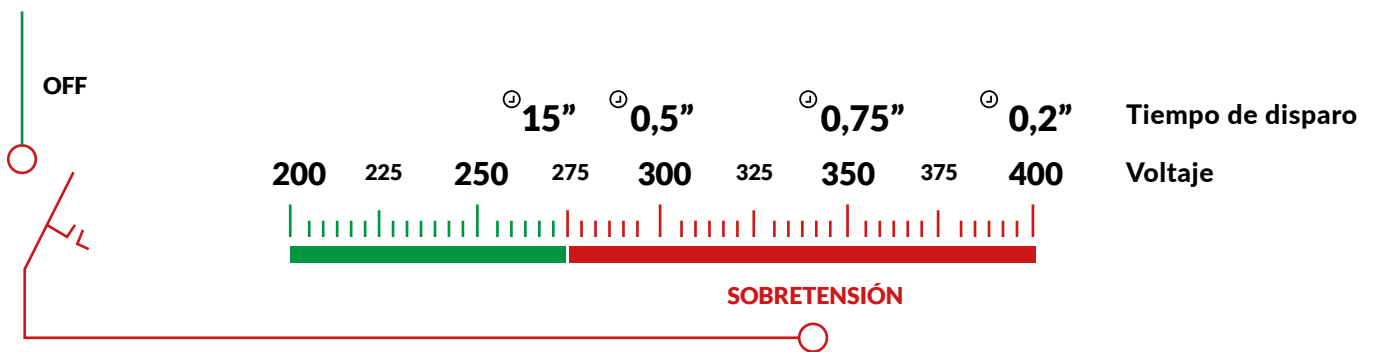

**Labels on the left:**

- Total Kwh
- Amperaje
- Voltaje
- Balance kWh
- Historial de operaciones

**Labels on the right:**

- Kwh Franja horaria
- Potencia activada
- Temperatura °C
- Corriente residual mA

**Bottom menu items:**

- On/Off
- Función Prepago
- Programa horarios
- Ajustes

### Funciones

- Consumo de potencia
- Ajusta la Temperatura
- Automatizaciones
- Programa horarios
- Monitorización energética
- Ajustar valores

\* Según la nueva normativa ERP ha habido un cambio en la medición de Lúmenes y vatios, pero sigue emitiendo la misma cantidad de luz. A medida que vayan entrando los nuevos modelos con ERP se irá actualizando en catálogo y cajas de color. Puede haber variación respecto a la caja del producto (comprobar en ficha técnica), todos los datos en catálogo están correctos salvo error tipográfico.

# Cajas de distribución estancas de superficie

IP65 - GRIS | IP40 - BLANCO

 1 UDS

DESCARGAR  
FICHA TÉCNICA 



## Color

Mantiene su color a lo largo del tiempo al aire libre

## Resistencia

Gran resistencia al aire libre, gracias a su protección y material ABS. Este material destaca por sus propiedades mecánicas y su capacidad para resistir impactos.

## Agrietamiento

Resiste el agrietamiento por tensión ambiental, alcoholes y muchos agentes de limpieza.

## No poroso

Evita que se fijen mohos, musgos, etc en la caja.

Fácil instalación



Protección IP65

IP65 - Gris ○



BOX-001 - 3 MÓDULOS 9,12 €



BOX-004 - 12 MÓDULOS 26,10 €



BOX-002 - 5 MÓDULOS 11,46 €



BOX-005 - 18 MÓDULOS 65,70 €



BOX-003 - 8 MÓDULOS 14,58 €



BOX-006 - 24 MÓDULOS 84,42 €

**IP40 - Blanco** ○



**BOX-007 - 6 MÓDULOS 11,85 €**



**BOX-010 - 16 MÓDULOS 25,74 €**



**BOX-008 - 8 MÓDULOS 16,02 €**



**BOX-011 - 24 MÓDULOS 40,50 €**



**BOX-009 - 12 MÓDULOS 21,54 €**



**BOX-012 - 36 MÓDULOS 54,48 €**

# Cajas de distribución estancas de superficie

Tapa transparente IP65 - Gris 



## Color

Mantiene su color a lo largo del tiempo al aire libre

## Resistencia

Gran resistencia al aire libre, gracias a su protección y material ABS. Este material destaca por sus propiedades mecánicas y su capacidad para resistir impactos.

## Agrietamiento

Resiste el agrietamiento por tensión ambiental, alcoholes y muchos agentes de limpieza.

## No poroso

Evita que se fijen mohos, musgos, etc en la caja.

• En los modelos superiores BOX-019 / 020



Apertura por palanca



Bisagra

IP65 - Gris ○



**BOX-013 - 3 MÓDULOS**

**PVPR 9,78 €**

Regleta de bornes No

Descargar Ficha técnica 



**BOX-017 - 18 MÓDULOS**

**PVPR 56,40 €**

Regleta de bornes Si

Descargar Ficha técnica 



**BOX-014 - 5 MÓDULOS**

**PVPR 11,25 €**

Regleta de bornes Si

Descargar Ficha técnica 



**BOX-018 - 24 MÓDULOS**

**PVPR 75,30 €**

Regleta de bornes Si

Descargar Ficha técnica 



**BOX-015 - 8 MÓDULOS**

**PVPR 22,20 €**

Regleta de bornes Si

Descargar Ficha técnica 



**BOX-019 - 36 MÓDULOS**

**PVPR 157,80 €**

Regleta de bornes Si

Descargar Ficha técnica 



**BOX-016 - 12 MÓDULOS**

**PVPR 27,75 €**

Regleta de bornes Si

Descargar Ficha técnica 



**BOX-020 - 54 MÓDULOS**

**PVPR 200,70 €**

Regleta de bornes Si

Descargar Ficha técnica 

# REGLETAS DE CONEXIÓN RÁPIDA

## Descripción:

Conecta rápida y fácilmente entre sí todo tipo de cables de diferentes tamaños hasta 4mm<sup>2</sup>.  
 Cuenta con un orificio de testeo en la parte frontal para un control óptimo de la conectividad.  
 Puede combinar cables de distintas secciones, rígidos o flexibles, de entre 0,5 y 4 mm<sup>2</sup>

Conecta los cables de manera  
**RÁPIDA y FÁCIL**



Alta  
 calidad



Rápido y  
 seguro



Inflamabilidad  
 UL94-V2



Seguridad



Para una buena conexión  
 introducir los cables  
 hasta el final

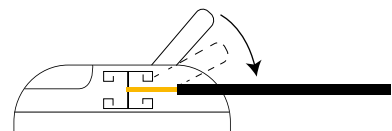

Conexión sin  
 necesidad de:

*Soldar, Cinta adhesiva, Empalmes*



Soldar



Cinta adhesiva



Empalmes

**Grado de protección**

Inflamabilidad: UL94-V2

**Materiales**

Polycarbonato PC



DESCARGAR FICHA TÉCNICA

Todas las regletas tienen un Diámetro mínimo 0,5mm<sup>2</sup>



		REF	UDS	PVPR
Regleta de conexión rápida	0,5 - 4mm <sup>2</sup> 1P	FCH-026	50	20,10 €



0,8cm

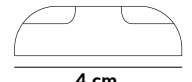

4 cm

1,3 cm



Regleta de conexión rápida	0,5 - 4mm <sup>2</sup> 2P	FCH-027	50	20,94 €
----------------------------	---------------------------	---------	----	---------



1,4cm

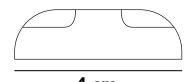

4 cm

1,3 cm



Regleta de conexión rápida	0,5 - 4mm <sup>2</sup> 3P	FCH-028	50	32,94 €
----------------------------	---------------------------	---------	----	---------

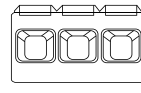

1,8cm

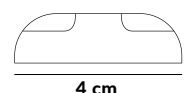

4 cm

1,3 cm

**Conector rápido universal**



		REF	UDS	PVPR
Conector rápido universal	0,5 - 4mm <sup>2</sup> 2P	FCH-029	100	28,20 €

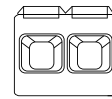

1,4cm

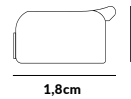

1,8cm

1cm



Conector rápido universal	0,5 - 4mm <sup>2</sup> 3P	FCH-030	100	32,88 €
---------------------------	---------------------------	---------	-----	---------

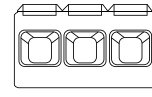

1,8cm

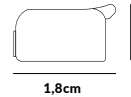

1,8cm

1cm



Diámetro max Ø6mm

Conector rápido universal	6mm 3P	FCH-032	50	39,48 €
---------------------------	--------	---------	----	---------

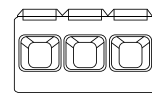

1,8cm

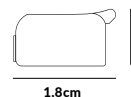

1,8cm

1cm



Conector rápido universal	0,5 - 4mm <sup>2</sup> 5P	FCH-031	50	24,60 €
---------------------------	---------------------------	---------	----	---------

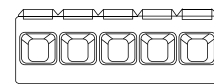

3cm

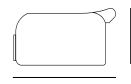

1,8cm

1cm

\* Según la nueva normativa ERP ha habido un cambio en la medición de Lúmenes y vatios, pero sigue emitiendo la misma cantidad de luz. A medida que vayan entrando los nuevos modelos con ERP se irá actualizando en catálogo y cajas de color. Puede haber variación respecto la caja del producto (comprobar en ficha técnica), todos los datos en catálogo están correctos salvo error tipográfico.

# REGLETAS DE CONEXIÓN

Bornas de conexión fabricadas en polipropileno con propiedades ignífugas, abocardadas en ambos extremos. Están disponibles en color blanco y negro y ofrecen una excelente resistencia mecánica junto con una alta fiabilidad en cuanto a seguridad eléctrica.

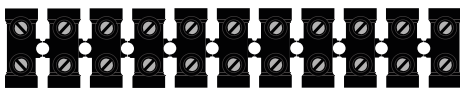
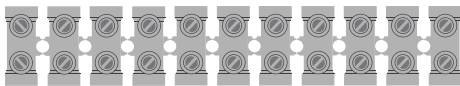
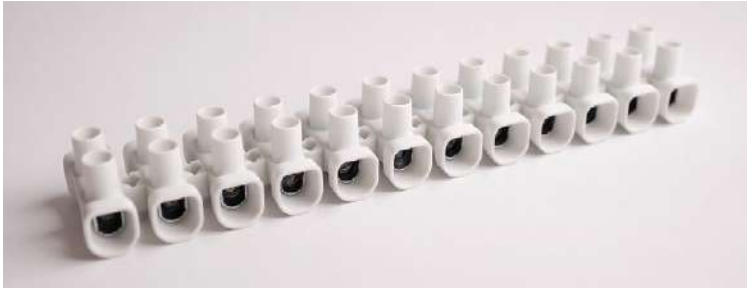

Ideales para simplificar las tareas del profesional eléctrico, cuentan con un diseño que permite separar los polos fácilmente dejando los bordes suaves.

Proporcionan una solución práctica y segura sin necesidad de utilizar herramientas para su corte. Se ofrecen en acabados blanco y negro.

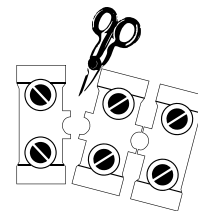
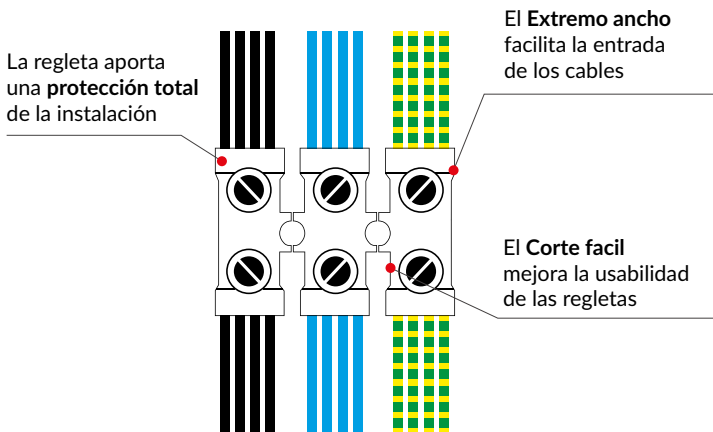

Otras marcas

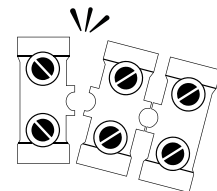

Regleta Atmoss

**Corte facil**

El **corte es más sencillo** y fácil, sin necesidad de utilizar herramientas de corte. Dejando el borde sin aristas.

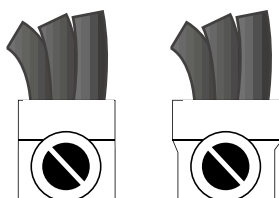

Otras marcas

Regleta Atmoss

**Abertura más ancha**

Las regletas tienen la **abertura más ancha** para facilitar la entrada de los cables, a diferencia de otras marcas que tienen la entrada más estrecha.



Otras marcas



Regleta Atmoss

**Tornillo imperdible**

El tornillo no se desprende al desatornillar.

## Regletas de conexión

Norma, certificados y materiales

### Materiales

Regletas de Polipropileno retardante  
 Inserciones de acero.  
 Tornillos de acero cincado.  
 Temperatura de trabajo  
 -40°C a +80°C



EN 60 998-2-1:2004  
 2011/65/UE/ROHS





DESCARGAR  
 FICHA TÉCNICA

450V

 10 UDS en blister plastificado



	Sección: <b>6mm<sup>2</sup></b>	 1000 uds/caja	REF	PVPR
				
Regleta de conexión para cable eléctrico	6mm <sup>2</sup> Blanco		FCH-006	0,87 €
Regleta de conexión para cable eléctrico	6mm <sup>2</sup> Negro		FCH-006	0,87 €

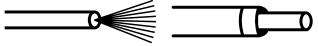

	Sección: <b>10mm<sup>2</sup></b>	 500 uds/caja	REF	PVPR
				
Regleta de conexión para cable eléctrico	10mm <sup>2</sup> Blanco		FCH-0010	1,08 €
Regleta de conexión para cable eléctrico	10mm <sup>2</sup> Negro		FCH-0010	1,08 €

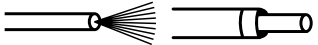

	Sección: <b>16mm<sup>2</sup></b>	 300 uds/caja	REF	PVPR
				
Regleta de conexión para cable eléctrico	16mm <sup>2</sup> Blanco		FCH-0016	2,04 €
Regleta de conexión para cable eléctrico	16mm <sup>2</sup> Negro		FCH-0016	2,04 €

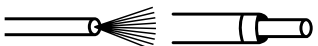

	Sección: <b>25mm<sup>2</sup></b>	 200 uds/caja	REF	PVPR
				
Regleta de conexión para cable eléctrico	25mm <sup>2</sup> Blanco		FCH-0025	3,45 €
Regleta de conexión para cable eléctrico	25mm <sup>2</sup> Negro		FCH-0025	3,45 €

# Punteras huecas

AISLADAS EN POLIPROPILENO RETARDANTE

## USO PROFESIONAL

*Conecta de forma más rápida, segura y sin esfuerzo.*

*Punteras huecas aisladas en polipropileno retardante.*

*Nuestras punteras huecas, fabricadas en cobre estañado de alta calidad recubiertas de latón, aseguran una unión fiable en tus instalaciones eléctricas.*



**Punteras huecas aisladas en polipropileno retardante**

Fabricadas en cobre electrolítico estañado recubiertas de latón.  
Diseñadas para una conexión más cómoda y flexible en las regletas.

Aislamiento: Polipropileno retardante

Temperatura de uso: Máx 105°C

Dimensiones: Según norma DIN 46228T4

**Punteras huecas simples**

 100 UDS en bolsa

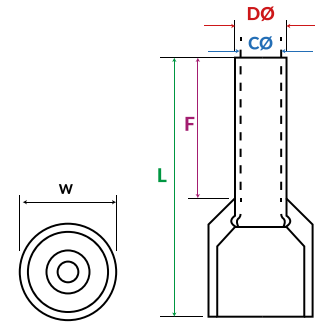

Ref	F	L	W	DØ	CØ	Sección	Color	PVPR
PHA-001	8.0	14.0	2.6	1.3	1.0	0.5	Blanco	0,58€
PHA-002	6.0	14.6	2.8	1.6	1.3	0.75	Azul	0,75€
PHA-003	8.0	14.6	3.0	1.8	1.5	1.0	Rojo	0,87€
PHA-004	6.0	14.6	3.5	2.1	1.8	1.5	Negro	0,90€
PHA-005	8.0	15.2	4.0	2.6	2.3	2.5	Gris	1,02€
PHA-006	9.0	16.5	4.4	3.2	2.8	4.0	Naranja	1,68€
PHA-007	12.0	20.0	6.3	3.5	3.5	6.0	Negro	2,55€
PHA-008	12.0	21.5	7.6	4.9	4.5	10.0	Marrón	3,33€
PHA-009	12.0	22.2	8.8	6.2	5.8	16.0	Plata	4,35€
PHA-010	16.0	29.0	11.2	7.9	7.5	25.0	Negro	8,07€
PHA-011	16.0	30.0	12.7	8.7	8.3	35.0	Rojo	10,95€
PHA-012	20.0	36.0	15.3	10.9	10.3	50.0	Azul	24,36€



**Punteras huecas dobles**

 100 UDS en bolsa

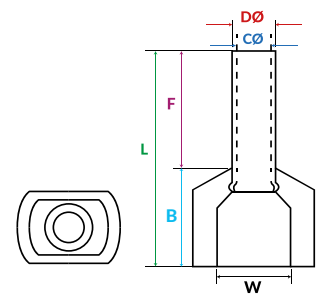

Ref	F	L	W	B	DØ	CØ	Sección	Color	PVPR
PHA-201	8	14,5	5	6.5	1.8	1,5	2x0.5	Blanco	1,47€
PHA-202	8	14,7	5,5	6.7	2.1	1.8	2x0.75	Gris	1,57€
PHA-203	8	15,1	5,5	7.1	2.3	2,0	2x1.0	Rojo	1,62€
PHA-204	8	15,5	6,4	7.2	2.6	2,3	2x1.5	Negro	2,58€
PHA-205	10	18,5	8	8.5	3.3	2,9	2x2.5	Azul	3,42€
PHA-206	12	23,1	8,8	11.1	4,2	3,8	2x4.0	Gris	4,62€
PHA-207	14	26,1	9,5	12.1	5,3	4,9	2x6.0	Amarillo	4,98€
PHA-208	14	26,6	12,6	12	6,9	6,5	2x10.0	Rojo	8,37€
PHA-209	14	31,3	19	17.3	8,7	8,3	2x16.0	Azul	11,49€



\* Según la nueva normativa ERP ha habido un cambio en la medición de Lúmenes y vatios, pero sigue emitiendo la misma cantidad de luz.  
A medida que vayan entrando los nuevos modelos con ERP se irá actualizando en catálogo y cajas de color.  
Puede haber variación respecto la caja del producto (comprobar en ficha técnica), todos los datos en catálogo estan correctos salvo error tipográfico.

# BRIDAS

ALTA RESISTENCIA



Bridas de **NYLON66** resistentes



**NEW!**

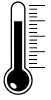

Temperatura de trabajo **-40°C + 85°C**



Mín. temperatura de instalación **20°C**



Grado de inflamabilidad del material **UL94V-2**

Ancho bridas

- 2,5 mm
- 3,6 mm
- 4,8 mm
- 6,8 mm
- 7,6 mm



DESCARGAR FICHA TÉCNICA

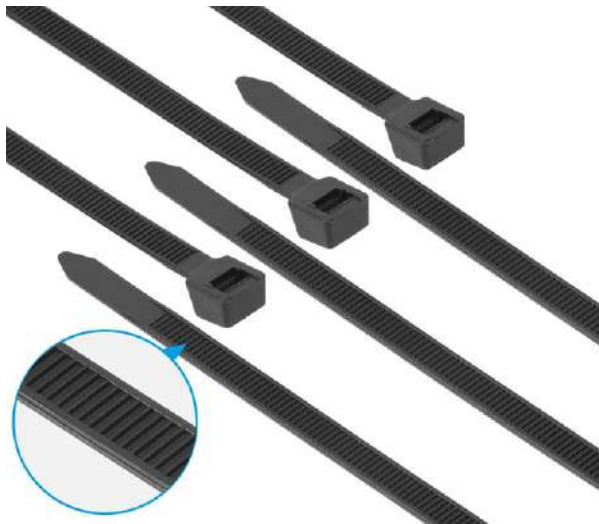

Dientes antideslizantes



Brida blanca



Cierre autoblocante más grueso



Diseño antideslizante



Terminación lisa para facilitar la inserción

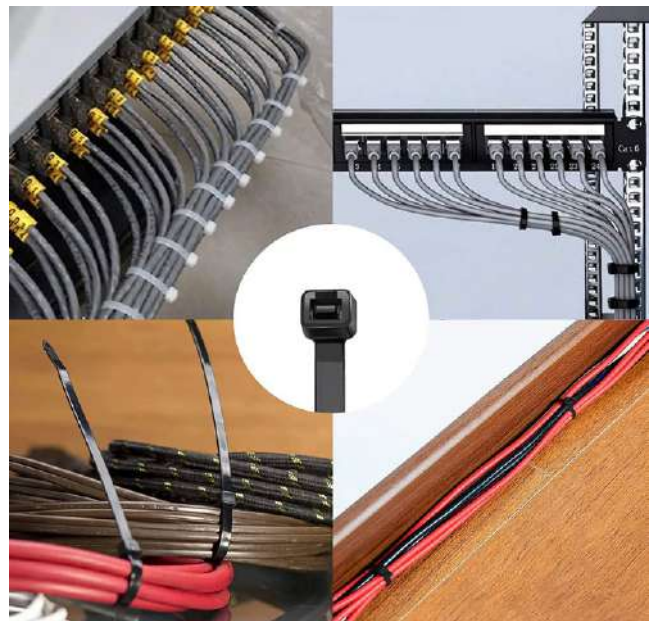



Diferentes modos de uso

**NEW!**

## TACOS A PRESIÓN para fijación de bridas

Los tacos a presión son adecuados para su uso en un amplio rango de materiales como hormigón, ladrillo o madera. Se instalan golpeando sobre el orificio (dependiendo del material). Debido a su amplia cabeza, los manojos de cables pueden colocarse a una distancia del enladrillado mediante el taco.

 Temperatura de trabajo  
-20°C + 85°C

 Mín. temperatura de instalación **20°C**

 Grado de inflamabilidad del material **UL94V-2**



- Buen comportamiento en ambientes húmedos y corrosivos
- Facilidad de montaje
- Perfecta retención de la brida.
- Las aletas flexibles ayudan a fijar y sujetar mejor los tubos, sin dañarlos.

• Para instalaciones de uso interior o exterior

- Ideal para superficies de
- Hormigón.
  - Ladrillo macizo
  - Forjado
  - Ladrillo hueco



100 UDS en bolsa

Material: Poliamida



TACOS A PRESIÓN PARA FIJACIÓN DE BRIDAS CON ALETA  
*Negro 8mm*

Ref

TCDA-001

PVPR

5,16€



TACOS A PRESIÓN PARA FIJACIÓN DE BRIDAS CON ALETA  
*Gris 8mm*

TCDA-002

5,16€





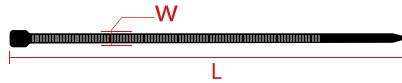







100 UDS en bolsa



**Bridas color NEGRO ●**

Ref		PVPR		W	L
BDA-001	BRIDA NEGRA 2.5*150mm NYLON66 IGNIFUGO	0,87€		2.5	150 mm
BDA-003	BRIDA NEGRA 3.6*200mm NYLON66 IGNIFUGO	1,83€		3.6	200 mm
BDA-005	BRIDA NEGRA 3.6*250mm NYLON66 IGNIFUGO	2,31€		3.6	250 mm
BDA-007	BRIDA NEGRA 3.6*300mm NYLON66 IGNIFUGO	2,61€		3.6	300 mm
BDA-009	BRIDA NEGRA 3.6*350mm NYLON66 IGNIFUGO	3,15€		3.6	350 mm
BDA-011	BRIDA NEGRA 3.6*500mm NYLON66 IGNIFUGO	5,10€		3.6	500 mm
BDA-015	BRIDA NEGRA 4.8*250mm NYLON66 IGNIFUGO	3,12€		4.8	250 mm
BDA-017	BRIDA NEGRA 4.8*300mm NYLON66 IGNIFUGO	3,57€		4.8	300 mm
BDA-019	BRIDA NEGRA 4.8*350mm NYLON66 IGNIFUGO	4,47€		4.8	350 mm
BDA-021	BRIDA NEGRA 4.8*500mm NYLON66 IGNIFUGO	6,51€		4.8	500 mm
BDA-023	BRIDA NEGRA 6.8*200mm NYLON66 IGNIFUGO	4,62€		6.8	200 mm







**Bridas color GRIS ●**

Ref		PVPR		W	L
BDA-002	BRIDA GRIS 2.5*150mm NYLON66 IGNIFUGO	0,93€		2.5	150 mm
BDA-004	BRIDA GRIS 3.6*200mm NYLON66 IGNIFUGO	1,95€		3.6	200 mm
BDA-006	BRIDA GRIS 3.6*250mm NYLON66 IGNIFUGO	2,43€		3.6	250 mm
BDA-008	BRIDA GRIS 3.6*300mm NYLON66 IGNIFUGO	2,76€		3.6	300 mm
BDA-010	BRIDA GRIS 3.6*350mm NYLON66 IGNIFUGO	3,33€		3.6	350 mm
BDA-012	BRIDA GRIS 3.6*500mm NYLON66 IGNIFUGO	5,37€		3.6	500 mm
BDA-016	BRIDA GRIS 4.8*250mm NYLON66 IGNIFUGO	3,27€		4.8	250 mm
BDA-018	BRIDA GRIS 4.8*300mm NYLON66 IGNIFUGO	3,75€		4.8	300 mm
BDA-020	BRIDA GRIS 4.8*350mm NYLON66 IGNIFUGO	4,71€		4.8	350 mm
BDA-022	BRIDA GRIS 4.8*500mm NYLON66 IGNIFUGO	6,81€		4.8	500 mm
BDA-024	BRIDA GRIS 6.8*200mm NYLON66 IGNIFUGO	4,86€		6.8	200 mm
BDA-026	BRIDA GRIS 7.6*500mm NYLON66 IGNIFUGO	12,81€		7.6	500 mm



Bridas color **NEGRO ULTRA UV** ●  100 UDS en bolsa









**W L**

Ref		PVPR		
BDA-106	BRIDA NEGRA 4.8*200mm ULTRA UV NYLON66 IGNIFUGO	3,15€		4.8 * 200 mm
BDA-107	BRIDA NEGRA 4.8*250mm ULTRA UV NYLON66 IGNIFUGO	4,62€		4.8 * 250 mm
BDA-108	BRIDA NEGRA 4.8*300mm ULTRA UV NYLON66 IGNIFUGO	5,28		4.8 * 300 mm
BDA-109	BRIDA NEGRA 4.8*350mm ULTRA UV NYLON66 IGNIFUGO	6,60€		4.8 * 350 mm
BDA-110	BRIDA NEGRA 4.8*500mm ULTRA UV NYLON66 IGNIFUGO	9,36€		4.8 * 500 mm
BDA-112	BRIDA NEGRA 7.6*500mm ULTRA UV NYLON66 IGNIFUGO	18,06€		7.6 * 500 mm

Bridas color **GRIS ULTRA UV** ●

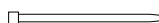
Ref		PVPR		
BDA-119	BRIDA GRIS 4.8*200mm ULTRA UV NYLON66 IGNIFUGO	3,21€		4.8 * 200 mm
BDA-120	BRIDA GRIS 4.8*250mm ULTRA UV NYLON66 IGNIFUGO	4,83€		4.8 * 250 mm
BDA-121	BRIDA GRIS 4.8*300mm ULTRA UV NYLON66 IGNIFUGO	5,55€		4.8 * 300 mm
BDA-122	BRIDA GRIS 4.8*350mm ULTRA UV NYLON66 IGNIFUGO	6,96€		4.8 * 350 mm

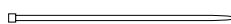
Bridas color **BLANCA ULTRA UV** ○

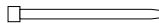
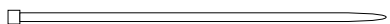
Ref		PVPR		
BDA-027	BRIDA BLANCA 2.5*150mm NYLON66 IGNIFUGO	1,29€		2.5 * 150 mm
BDA-028	BRIDA BLANCA 3.6*200mm NYLON66 IGNIFUGO	2,73 €		3.6 * 200 mm
BDA-029	BRIDA BLANCA 3.6*250mm NYLON66 IGNIFUGO	3,42€		3.6 * 250 mm
BDA-030	BRIDA BLANCA 3.6*300mm NYLON66 IGNIFUGO	3,87€		3.6 * 300 mm
BDA-031	BRIDA BLANCA 3.6*350mm NYLON66 IGNIFUGO	4,68€		3.6 * 350 mm
BDA-032	BRIDA BLANCA 3.6*500mm NYLON66 IGNIFUGO	7,56€		3.6 * 500 mm
BDA-033	BRIDA BLANCA 4.8*200mm NYLON66 IGNIFUGO	3,15€		4.8 * 200 mm
BDA-034	BRIDA BLANCA 4.8*250mm NYLON66 IGNIFUGO	4,62€		4.8 * 250 mm
BDA-035	BRIDA BLANCA 4.8*300mm NYLON66 IGNIFUGO	5,28€		4.8 * 300 mm
BDA-036	BRIDA BLANCA 4.8*350mm NYLON66 IGNIFUGO	6,60€		4.8 * 350 mm
BDA-037	BRIDA BLANCA 4.8*500mm NYLON66 IGNIFUGO	9,63€		4.8 * 500 mm
BDA-038	BRIDA BLANCA 6.8*200mm NYLON66 IGNIFUGO	6,84€		6.8 * 200 mm
BDA-039	BRIDA BLANCA 7.6*500mm NYLON66 IGNIFUGO	18,06€		7.6 * 500 mm

\* Según la nueva normativa ERP ha habido un cambio en la medición de Lúmenes y vatios, pero sigue emitiendo la misma cantidad de luz.

A medida que vayan entrando los nuevos modelos con ERP se irá actualizando en catálogo y cajas de color.

Puede haber variación respecto la caja del producto (comprobar en ficha técnica), todos los datos en catálogo están correctos salvo error tipográfico.

# Cintas eléctricas

USO PROFESIONAL



20m  
x19mm (Ancho)  
0,15mm Grosor



## CINTAS ELÉCTRICAS DE PRIMERA CALIDAD PARA AISLAMIENTO ELÉCTRICO

Norma: EN 60454-3-12:2006 NORMA CE 2014/35/EU

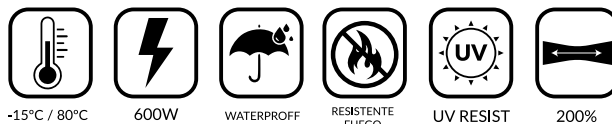

## CARACTERÍSTICAS

- Alta flexibilidad.
- Alta resistencia a la rotura.
- Alta recuperación de elasticidad
- Ignífugo
- Buena protección mecánica y eléctrica
- Aislamiento de hilos y cables eléctricos hasta 600v, 80°C
- Espesor 0,15mm
- Composición, cinta de PVC con adhesivo de caucho

10 UDS en blister plastificado

**DESCARGAR**  
FICHA TÉCNICA

Medidas 20m | 19mm | 0,15mm / 19mm



SE VENDE EN PAQUETE DE 10UDS - PRECIO UNITARIO

10 UDS      Ref      PVPR

CINTA AISLANTE PVC IGNÍFUGO      **NEGRO**      CIN-001      1,44€



SE VENDE EN PAQUETE DE 10UDS - PRECIO UNITARIO

10 UDS      Ref      PVPR

CINTA AISLANTE PVC IGNÍFUGO      **AZUL**      CIN-002      1,44€



SE VENDE EN PAQUETE DE 10UDS - PRECIO UNITARIO

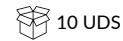

Ref PVPR

CINTA AISLANTE PVC IGNÍFUGO **AMARILLO-VERDE** CIN-003 1,44€



SE VENDE EN PAQUETE DE 10UDS - PRECIO UNITARIO

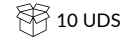

Ref PVPR

CINTA AISLANTE PVC IGNÍFUGO **BLANCO** CIN-004 1,44€



SE VENDE EN PAQUETE DE 10UDS - PRECIO UNITARIO

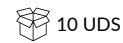

Ref PVPR

CINTA AISLANTE PVC IGNÍFUGO **VERDE** CIN-005 1,44€



SE VENDE EN PAQUETE DE 10UDS - PRECIO UNITARIO

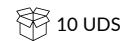

Ref PVPR

CINTA AISLANTE PVC IGNÍFUGO **GRIS** CIN-006 1,44€



SE VENDE EN PAQUETE DE 10UDS - PRECIO UNITARIO

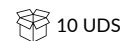

Ref PVPR

CINTA AISLANTE PVC IGNÍFUGO **ROJO** CIN-007 1,44€



SE VENDE EN PAQUETE DE 10UDS - PRECIO UNITARIO

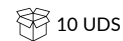

Ref PVPR

CINTA AISLANTE PVC IGNÍFUGO **AMARILLO** CIN-008 1,44€



SE VENDE EN PAQUETE DE 10UDS - PRECIO UNITARIO

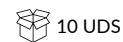

Ref PVPR

CINTA AISLANTE PVC IGNÍFUGO **MARRÓN** CIN-009 1,44€

# POLÍTICA DE DEVOLUCIONES

No se aceptarán devoluciones de materiales transcurridos 30 días desde su compra.

Los retornos se efectuarán a portes pagados, excepto aquellos que se realicen por error de **ATMOSS S.L.**, rogando que se realicen por la misma agencia por la cual se expidieron.

Toda devolución dentro de los plazos establecidos y previamente aceptada, llevará implícito un pedido de compensación.

No se aceptará la devolución en los siguientes casos:

**A.** Materiales no fabricados o comercializados por **ATMOSS S.L**

**B.** Material en buen estado que esten descatalogados.

**C.** Materiales en buen estado que hayan sido usados con anterioridad a la devolución.

**D.** Materiales que hayan sido manipulados.

**E.** Devoluciones de productos en buen estado con malas condiciones físicas de los embalajes.

**F.** Material en buen estado cuyo suministro supera los seis meses de la fecha de facturación.

**G.** En caso de una devolución con anterioridad al plazo mencionado en el apartado F., se aplicará un 15% de depreciación al material.

**H.** Para realizar una propuesta de devolución es necesario indicar el número de factura o albarán del material que se pretende devolver.

**J.** Los productos que lleven pilas incluidas y puedan estar defectuosas por el tiempo, no se efectuará el abono.

Si el comprador acredita devolver material por fallos técnicos del mismo o mal funcionamiento, será necesaria la comprobación técnica por **ATMOSS S.L** del material o de la instalación donde estuviera montado.

**A.** El proceso de comprobación del material puede durar hasta 15 días tras su recepción.

**B.** En caso de confirmar fallo del material, se le compensará al comprador (mediante abono o sustitución gratuita del material adquirido) sin que pueda exigirse daño o perjuicios de clase alguna.

**C.** Si por diversos motivos, la reposición de un material ha de ser adelantada a la recepción del mismo, el albarán emitido por **ATMOSS S.L** se realizará **CON CARGO**.

**A.** El proceso de comprobación del material puede durar hasta 15 días tras su recepción.

**B.** En caso de confirmar fallo del material, se le compensará al comprador (mediante abono o sustitución gratuita del material adquirido) sin que pueda exigirse daño o perjuicios de clase alguna.

**C.** Si por diversos motivos, la reposición de un material ha de ser adelantada a la recepción del mismo, el albarán emitido por **ATMOSS S.L** se realizará **CON CARGO**.

Tras la verificación de las devoluciones se realizará su respectivo abono o sustitución, siempre que proceda.

Una vez superadas las 48 horas de entrega del material, **ATMOSS S.L** no aceptará reclamaciones relativas a roturas de material, errores en las cantidades o errores de modelos. En caso de notificar en el justificante de entrega por parte de la transportadora que la mercancía está sujeta a revisión, el plazo se extenderá a 7 días naturales siguientes a la fecha en la que se efectuó el suministro.

# CONDICIONES DE GARANTÍA

**ATMOSS S.L** trabaja con fabricantes de alta calidad, y exige que todos sus productos se desarrollen con los más altos niveles de fiabilidad y eficiencia.

Los productos ofrecidos de **ATMOSS S.L**, tienen 3 años de garantía, desde la entrega de los mismos, desde la fecha de compra (fecha de factura).

La garantía de los productos vendidos por **ATMOSS S.L** se presta y establece en virtud de la normativa contenida en la LEY 23/2003, del 10 de julio, de garantías en la Venta de Bienes de Consumo, marco legal que tiene por objeto facilitar al consumidor distintas opciones.

**ATMOSS S.L**, aplicará la presente garantía cuando cualquier unidad no funcione o lo haga incorrectamente. El personal de **ATMOSS S.L** procedería entonces a los test pertinentes a fin de terminar las causas de tales anomalías.

**ATMOSS S.L**, gestionará la reposición o reparación del material en el menor plazo de tiempo posible, una vez se determine que las causas del mal funcionamiento del producto tienen su origen en la fabricación.

Siempre, el producto a reparar o sustituir, deberá corresponder al enviado por **ATMOSS S.L**. Adjuntando en el albarán de entrega y/o factura. **ATMOSS S.L** atenderá a los citados servicios por es su naturaleza como Importador y Distribuidor para todo el territorio Español.

La garantía de **ATMOSS S.L** excluye los siguientes puntos:

- El desgaste o uso indebido de horas y averías producidas por una incorrecta instalación o manipulación y almacenaje. El fallo por desgaste, uso indebido y negligencia antes o durante el uso.
- Cualquier tipo de reclamación por pérdida natural de luminosidad o degradación de luminosidad del chip led **ATMOSS S.L**, también se excluye la garantía.
- **ATMOSS S.L** no se hará cargo de posibles daños que puedan resultar por mal uso, instalación no profesional, o mal funcionamiento como corto circuito. La garantía no será válida en caso de factores externos al uso normal del producto, tales como subidas o bajadas de tensión, utilización de accesorios inadecuados o prohibidos por el fabricante, o manejo incorrecto por parte del cliente o terceras personas no autorizadas por los fabricantes.
- Esta garantía limitada no cubre defectos que ocurran debido a una instalación inapropiada de ningún tipo. **ATMOSS S.L** no cubrirá los gastos de mano de obra adicional o garantías como trabajo

asociado con reemplazos del producto. Este documento de garantía representa la única garantía expresa o implícita y no existe otro tipo de garantía.

- Otros signos de aparente trato incorrecto anularán también la presente garantía.
- Así mismo, nos reservamos el derecho a estudiar cada producto devuelto por especialistas independientes quedando la garantía exenta en caso de demostrarse por las autoridades competentes que la rotura ha sido causada por el cliente o usuario, así como la rotura parcial del producto para forzar el uso de la garantía para la devolución o reintegro del producto. En caso de ser así, los gastos para demostración de culpa correrán a cargo del cliente. Todos los aspectos de esta garantía no recogidos en esta ley 23/2003, será de aplicación el régimen contenido en la Ley 7/1996, del 15 de Enero, de Ordenación del Comercio Minorista.
- Las imágenes y descripciones de los productos **ATMOSS S.L**, son reales, salvo error tipográfico

## Reclamaciones

Como consecuencia del transporte, se aceptarán en un plazo de 3 días siguientes a la recepción de la mercancía, acompañando fotocopia del albarán de la agencia de transporte en el que se consistirán la incidencia de rotura, mal estado, etc.

Toda reclamación dará lugar a un expediente de incidencia que llevará un seguimiento de las causas al objeto de realizar las oportunas acciones correctoras.

## Pago de facturas

**ATMOSS S.L** se reserva el derecho de propiedad sobre las mercancías, incluso frente a terceros, en tanto no se cumpla íntegramente el pago del importe.

Los pagos se harán siempre efectivos en los términos pactados con el cliente. Los gastos que se originen como consecuencia de la devolución de efectos girados serán a cargo del cliente, así como los gastos financieros ocasionados por cualquier modificación.

**ATMOSS S.L** se reserva el derecho a suspender cualquier envío de material por impago parcial o total de algún suministro anterior.

## Jurisdicción

Para toda cuestión, diferencia, interpretación, etc., que pudiera surgir, las partes se someten expresamente a la jurisdicción y competencia de los Juzgados y Tribunales de Alicante.

**Referente a las instalaciones con elementos solares  
TENER EN CUENTA LAS SIGUIENTES INDICACIONES**

### **1- Orientación y ubicación**

Se deberá tener en cuenta la orientación y ubicación de la luminaria teniendo en cuenta que la luz solar varía de acuerdo a la estación del año. Tener en cuenta árboles, edificios, cualquier elemento que produzca sombra.

### **2- Mantenimiento**

La placa solar tendrá que tener un mantenimiento de limpieza, por lo tanto hay que tener en cuenta la accesibilidad a esta.

### **3- Estudio lumínico**

Para grandes instalaciones se recomienda un estudio lumínico para lograr el rendimiento óptimo.

La empresa Atmoss.S.L no se hará cargo del uso indebido de estas luminarias solares.

## **POLÍTICA DE DEVOLUCIONES y GARANTÍA - SOLAR**

Todos los productos consumibles están cubiertos por una garantía legal de dos años frente a las faltas de conformidad en virtud de lo previsto en la Ley General para la Defensa de los Consumidores y Usuarios (Real Decreto Legislativo 1/2007).

- Durante los **primeros 6 meses** el consumidor debe acreditar que existe un defecto que hace que el producto no sea conforme, se presume que el defecto es de origen o fabricación. El vendedor deberá probar que el defecto es imputable a un uso inapropiado.

- Durante los **18 meses restantes**, el consumidor debe probar que el defecto es originario y no caso fortuito, previo a la adquisición, de conformidad con las reglas generales sobre la carga de la prueba (arts. 217 y sig. LEC). Por lo tanto deberá además de aportarse el justificante de la compra, probar que ese defecto era originario (a través de un peritaje) y que ese defecto no es imputable al consumidor debido a un mal uso o el desgaste natural del producto.

No se aceptarán devoluciones de materiales transcurridos 30 días desde su compra.

La batería de Litio se considera consumible y tiene una degradación de horas con el uso del tiempo.

Los retornos se efectuarán a portes pagados, excepto aquellos que se realicen por error de ATMOSS S.L, rogando que se realicen por la misma agencia por la cual se expidieron.

Toda devolución dentro de los plazos establecidos y previamente aceptada, llevará implícito un pedido de compensación.



**DESCARGA NUESTROS  
CATÁLOGOS DESDE EL QR**



Calle los Mecánicos, 5  
03130 Pol. Ind. Santa Pola (Alicante) España  
Tel. +34 966 693 404 / 865 664 858

**atmoss@atmoss.es**  
**www.atmoss.es**